

Hydraulic seals

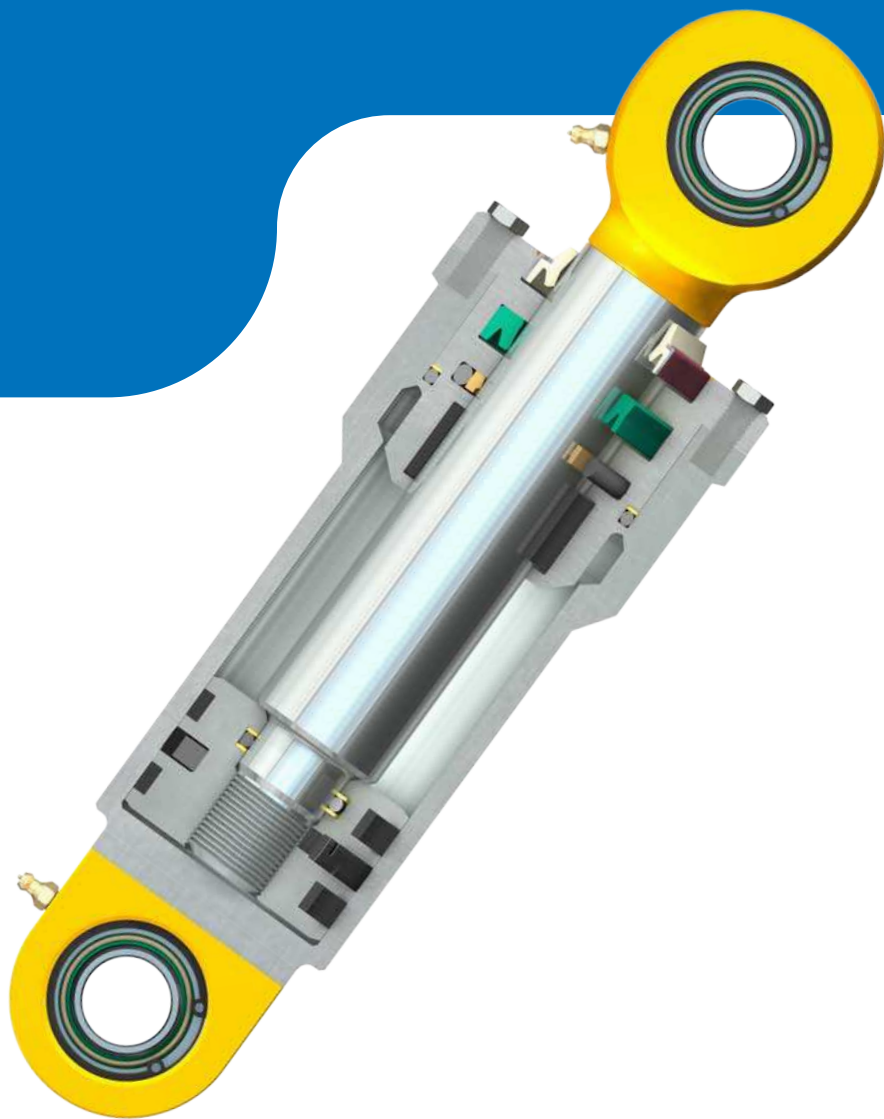

SKF mobile apps

SKF mobile apps are available from both Apple App Store and Google Play. These apps provide useful information and allow you to make critical calculations, providing SKF Knowledge Engineering at your fingertips.

Register your catalogue

You can get updates for this catalogue via email if you register at skf.com/catalogues.



Apple App Store

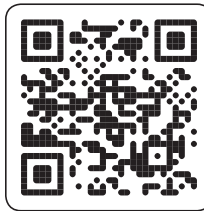

Google Play

© SKF, ECOPUR, H-ECOPUR, S-ECOPUR, X-ECOPUR, XH-ECOPUR, FLUOROTREL, LUBRITHANE, SEAL JET, SPECTRASEAL, TEFLATHANE and X-SLIDE are registered trademarks of the SKF Group.

Apple is a trademark of Apple Inc., registered in the US and other countries.

Google Play is a trademark of Google Inc.

© SKF Group 2014

The contents of this publication are the copyright of the publisher and may not be reproduced (even extracts) unless prior written permission is granted. Every care has been taken to ensure the accuracy of the information contained in this publication but no liability can be accepted for any loss or damage whether direct, indirect or consequential arising out of the use of the information contained herein.

PUB SE/P1 12393/2 EN · August 2014

This publication supersedes publication 5397.

Certain image(s) used under license from Shutterstock.com

SKF hydraulic seals – general technical information . . .	21	1
Piston seals	45	2
Rod and buffer seals	111	3
Wiper seals	207	4
Guide rings and guide strips	249	5
O-rings and back-up rings	291	6
Other fluid power applications	347	7
Product index	352	8

Content

Unit conversions	4
Foreword	5
This is SKF	8
SKF – the knowledge engineering company	10
Introduction to fluid power	12
Hydraulic cylinders	13
Cylinder classification	14
Hydraulic seals and guides	14
SKF hydraulic seals and guides capabilities	16
Customized sealing solutions	16
SKF SEAL JET system	17
Criteria for seal selection	18
1 SKF hydraulic seals – general technical information	21
Specifications for effective sealing systems	22
Gap extrusion	34
Storage	36
Installation and assembly	38
2 Piston seals	45
Product tables	
2.1 MPV, metric sizes	59
2.2 DPV, inch sizes	61
2.3 LPV, metric sizes	63
2.4 CPV, inch sizes	65
2.5 GH, metric sizes	67
GH, inch sizes	70
2.6 APR, metric sizes	77
APR, inch sizes	79
2.7 LCP, metric sizes	83
LCP, inch sizes	85
2.8 LTP, inch sizes	87
2.9 CUT, metric sizes	91
2.10 SCP, inch sizes	95
2.11 MD-L, metric sizes	99
2.12 UNP, metric sizes	103
UNP, inch sizes	105

3 Rod and buffer seals	111
Product tables	
3.1 S1S, metric sizes	123
3.2 ZBR, metric sizes	127
ZBR, inch sizes	131
3.3 SIL, metric sizes	135
3.4 PTB, metric sizes	139
PTB, inch sizes	149
3.5 STD, inch sizes	165
3.6 DZ, metric sizes	179
DZ, inch sizes	180
3.7 DZR, metric sizes	185
DZR, inch sizes	186
3.8 RBB, metric sizes	189
RBB, inch sizes	191
3.9 S9B, metric sizes	193
S9B, inch sizes	196
3.10 RSB, inch sizes	199
4 Wiper seals	207
Product tables	
4.1 PA, metric sizes	217
4.2 MCW, metric sizes	221
MCW, inch sizes	223
4.3 PAD and PADV, metric sizes	227
4.4 DTW, metric sizes	229
DTW, inch sizes	232
4.5 DX, inch sizes	237
4.6 HW, metric sizes	241
HW, inch sizes	243
5 Guide rings and guide strips	249
Product tables	
5.1 WAT rod or piston guide rings, metric sizes	256
5.2 WAT rod or piston guide rings, inch sizes	262
5.3 RGR rod guide rings, metric sizes	276
5.4 PGR piston guide rings, metric sizes	280
6 O-rings and back-up rings	291
Product tables	
6.1 OR O-rings in static radial sealing, metric sizes	300
6.2 OR O-rings in static radial sealing, inch sizes	316
6.3 STR Back-up rings in static radial sealing, metric sizes	324
6.4 STR Back-up rings in static radial sealing, inch sizes by dash-number, metric dimensions	328
6.5 STR Back-up rings in static radial sealing, inch sizes by dash-number	338
7 Other fluid power applications	347
8 Product index	352

Unit conversions

Unit conversions

Quantity	Unit	Conversion			
Length	inch	1 mm	0.03937 in.	1 in.	25,40 mm
	foot	1 m	3.281 ft.	1 ft.	0,3048 m
	yard	1 m	1.094 yd.	1 yd.	0,9144 m
	mile	1 km	0.6214 mi.	1 mi.	1,609 km
Speed, velocity	foot per second	1 m/s	3.28 ft/s	1 ft/s	0,30480 m/s
	foot per minute	1 m/s	196.8504 ft/min	1 ft/min	0,00508 m/s
	mile per hour	1 km/h	0.6214 mph	1 mph	1,609 km/h
Force	pound-force	1 N	0.225 lbf.	1 lbf.	4,4482 N
Pressure, stress	pounds per square inch	1 MPa	145 psi	1 psi	$6,8948 \times 10^3$ Pa
		1 N/mm ²	145 psi		
		1 bar	14.5 psi	1 psi	0,068948 bar
Temperature	degree	Celsius	$t_c = 0.555 (t_f - 32)$	Fahrenheit	$t_f = 1.8 t_c + 32$

Foreword

This catalogue contains the standard assortment of SKF hydraulic seals and guides typically used in hydraulic cylinders. To provide the highest levels of quality and customer service, these products are available worldwide through SKF sales channels. For information about lead times and deliveries, contact your local SKF representative or SKF Authorized Distributor.

This catalogue reflects SKF's state-of-the-art technology and production capabilities as of 2014. The data contained within may differ from that shown in earlier catalogues because of redesign, technological developments, or revised calculation methods. SKF reserves the right to continuously improve its products with respect to materials, design and manufacturing methods, some of which are driven by technological developments.

Getting started

Introduction to fluid power provides an overview over hydraulic cylinder types and classification, a reference to SKF customized solutions and standard assortment of hydraulic seals and guides. The first chapter contains general technical information. Seal counter-surface finish properties, materials, fluid media and gap extrusion are discussed in detail. Furthermore, product storage and installation information is included.

Guidance values

Since several factors simultaneously affect the sealing system and seal performance, all stated values in graphs and tables in this publication should be considered as guidelines only and not as absolute values for practical applications.

How best to use this catalogue

The catalogue follows an easy principle:

- *Introduction to fluid power* (→ **pages 12 to 18**) provides basic information about hydraulic seals.
- Chapter 1 (→ **pages 21 to 43**) provides general technical information, such as counter-surface finish properties, materials, fluid media.
- Chapters 2 to 6 provide product type specific information. If applicable, a profile overview at the beginning shows the different profiles with a brief description and reference to more information inside the chapter. Product type and profile characteristics are discussed in detail. The profile data tables provide product specifications per profile followed by the relevant product tables with dimensions per item. At the end of the chapter more profiles of the specific type are outlined, including examples of the machined seal profiles manufactured with the SKf SEAL JET technology.
- Chapter 7 (→ **pages 347 to 351**) provides some information on other types of fluid power seals used both in hydraulic cylinders and other applications.
- Chapter 8 contains the product index (→ **page 352**) sorted by the profiles.

Find product details quickly

Blue tabs on each right hand page show the chapter or product table number.

A quick way to access detailed product data is via the product table numbers. They are listed in the full table of contents at the front of the catalogue, in the table of contents of each product chapter and in the product index.

Profile	Description	Additional information → page
MPV	Polyurethane slide ring, nitrile rubber energizer; suitable for heavy duty applications	50
DPV	Polyurethane slide ring, nitrile rubber energizer; fits wide, shallow groove housings; suitable for heavy duty applications	51
LPV	Polyether-based polyurethane slide ring, nitrile rubber energizer; suitable for light to medium duty applications	51
CPV	Polyurethane slide ring, nitrile rubber energizer; suitable for light to medium duty applications	62

Profile overview

Tolerances	Dimensions	Designation					
H	L	D					
max.	min.						
+0.000	0.889	+0.000	0.128	0.149	0.015	0.125	SKH-1187-AD1
+0.002	0.927	+0.003	0.163	0.175	0.015	0.125	GHD-1187-AD2
+0.002	1.016	+0.003	0.062	0.067	0.025	0.125	GHD-1187-AD3
+0.002	0.982	+0.003	0.128	0.149	0.015	0.125	SKH-1256-AD1
+0.002	1.076	+0.003	0.163	0.175	0.015	0.125	GHD-1256-AD2
+0.002	1.152	+0.003	0.062	0.067	0.025	0.125	GHD-1256-AD3
+0.002	1.118	+0.003	0.128	0.149	0.015	0.125	SKH-1322-AD1
+0.002	1.212	+0.003	0.163	0.175	0.015	0.125	GHD-1322-AD2
+0.002	1.288	+0.003	0.062	0.067	0.025	0.125	GHD-1322-AD3
+0.002	1.254	+0.003	0.128	0.149	0.015	0.125	SKH-1374-AD1
+0.002	1.348	+0.003	0.163	0.175	0.015	0.125	GHD-1374-AD2
+0.002	1.424	+0.003	0.062	0.067	0.025	0.125	GHD-1374-AD3
+0.002	1.390	+0.003	0.128	0.149	0.015	0.125	SKH-1432-AD1
+0.002	1.484	+0.003	0.163	0.175	0.015	0.125	GHD-1432-AD2
+0.002	1.560	+0.003	0.062	0.067	0.025	0.125	GHD-1432-AD3
+0.002	1.526	+0.003	0.128	0.149	0.015	0.125	SKH-1487-AD1
+0.002	1.620	+0.003	0.163	0.175	0.015	0.125	GHD-1487-AD2
+0.002	1.696	+0.003	0.062	0.067	0.025	0.125	GHD-1487-AD3
+0.002	1.662	+0.003	0.128	0.149	0.015	0.125	SKH-1542-AD1
+0.002	1.756	+0.003	0.163	0.175	0.015	0.125	GHD-1542-AD2
+0.002	1.832	+0.003	0.062	0.067	0.025	0.125	GHD-1542-AD3
+0.002	1.798	+0.003	0.128	0.149	0.015	0.125	SKH-1607-AD1
+0.002	1.892	+0.003	0.163	0.175	0.015	0.125	GHD-1607-AD2
+0.002	1.968	+0.003	0.062	0.067	0.025	0.125	GHD-1607-AD3

Numbered product table

Colour coding for material

The product illustrations in this catalogue use a colour coding system to indicate the material group, but they do not match the actual material colours. For information about the actual material colours, refer to *Materials* (→ page 26).

Consistent colour coding for material groups

 Thermoplastic polyurethane elastomers (TPU), moulded articles

 Thermoplastic polyurethane elastomers (TPU), machined articles

 Rubbers

 Rigid thermoplastics

 Unfilled PTFE and other engineered plastics

 Filled PTFE

 Phenolic resins

 Thermoplastic polyester elastomers (TPC)

 Metals

Units of measurement

This catalogue is for global use. Therefore, the predominant units of measurement are in accordance with ISO 80000-1. Imperial units are used whenever necessary. Unit conversions can be made using the conversion table (→ page 4).

For easier use, some values are provided in both metric and imperial values. Values are typically rounded. Therefore, the two values do not always match according to the conversion formula.

This is SKF

From one simple but inspired solution to a misalignment problem in a textile mill in Sweden, and fifteen employees in 1907, SKF has grown to become a global industrial knowledge leader. Over the years, we have built on our expertise in bearings, extending it to seals, mechatronics, services and lubrication systems. Our knowledge network includes 46 000 employees, 15 000 distributor partners, offices in more than 130 countries, and a growing number of SKF Solution Factory sites around the world.



Res

We have hands-on experience in over forty industries based on our employees' knowledge of real life conditions. In addition, our world-leading experts and university partners pioneer advanced theoretical research and development in areas including tribology, condition monitoring, asset management and bearing life theory. Our ongoing commitment to research and development helps us keep our customers at the forefront of their industries.



SKF Solution Factory makes SKF knowledge and manufacturing expertise available locally to provide unique solutions and services to our customers.

Meeting the toughest challenges

Our network of knowledge and experience, along with our understanding of how our core technologies can be combined, helps us create innovative solutions that meet the toughest of challenges. We work closely with our customers throughout the asset life cycle, helping them to profitably and responsibly grow their businesses.

Working for a sustainable future

Since 2005, SKF has worked to reduce the negative environmental impact from our operations and those of our suppliers. Our continuing technology development resulted in the introduction of the SKF BeyondZero portfolio of products and services which improve efficiency and reduce energy losses, as well as enable new technologies harnessing wind, solar and ocean power. This combined approach helps reduce the environmental impact both in our operations and our customers' operations.



Working with SKF IT and logistics systems and application experts, SKF Authorized Distributors deliver a valuable mix of product and application knowledge to customers worldwide.



SKF – the knowledge engineering company

Our knowledge – your success

SKF Life Cycle Management is how we combine our technology platforms and advanced services, and apply them at each stage of the asset life cycle, to help our customers to be more successful, sustainable and profitable.

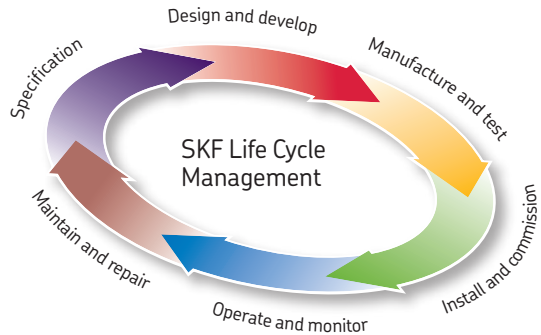

Working closely with you

Our objective is to help our customers improve productivity, minimize maintenance, achieve higher energy and resource efficiency, and optimize designs for long service life and reliability.

Innovative solutions

Whether the application is linear or rotary or a combination, SKF engineers can work with you at each stage of the asset life cycle to improve machine performance by looking at the entire

application. This approach doesn't just focus on individual components like bearings or seals. It looks at the whole application to see how each component interacts with each other.

Design optimization and verification

SKF can work with you to optimize current or new designs with proprietary 3-D modelling software that can also be used as a virtual test rig to confirm the integrity of the design.



Bearings

SKF is the world leader in the design, development and manufacture of high performance rolling bearings, plain bearings, bearing units and housings.



Machinery maintenance

Condition monitoring technologies and maintenance services from SKF can help minimize unplanned downtime, improve operational efficiency and reduce maintenance costs.



Sealing solutions

SKF offers standard seals and custom engineered sealing solutions to increase uptime, improve machine reliability, reduce friction and power losses, and extend lubricant life.



Mechatronics

SKF fly-by-wire systems for aircraft and drive-by-wire systems for off-road, agricultural and forklift applications replace heavy, grease or oil consuming mechanical and hydraulic systems.



Lubrication solutions

From specialized lubricants to state-of-the-art lubrication systems and lubrication management services, lubrication solutions from SKF can help to reduce lubrication related downtime and lubricant consumption.



Actuation and motion control

With a wide assortment of products – from actuators and ball screws to profile rail guides – SKF can work with you to solve your most pressing linear system challenges.

Introduction to fluid power

Fluid power systems transfer and utilize mechanical power through a working fluid. Energy is transmitted, stored and used through the transfer and pressure of fluids. There are two main types of fluid power system:

- hydraulic – using liquid, such as oil, for the working fluid
- pneumatic – using gas, such as air, for the working fluid

Fig. 1

Double-acting hydraulic cylinder

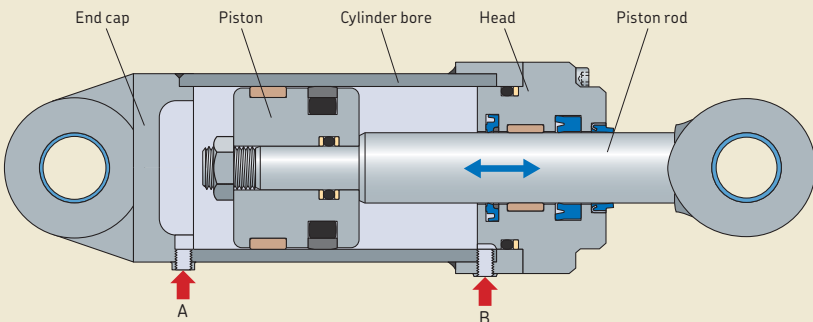

Hydraulic cylinders

A hydraulic cylinder is a linear actuator used to push or pull a load, or to selectively resist motion under load, by means of fluid pressure. Double-acting cylinders, the most common type, are able to push and pull (→ **fig. 1**). High pressure fluid pumped into the extend chamber (port “A”) acts on the piston to push the piston rod out, thereby extending the length of the cylinder. Inversely, to retract the piston rod and reduce the length of the assembly, high pressure fluid is pumped into the retract chamber (port “B”) and acts on the opposite side of the piston.

Other cylinder types are shown in **figure 2**. A cylinder which can only push but not pull is referred to as a single-acting cylinder. High pressure fluid is pumped into the extend chamber (port “A”) and acts on the piston to push the piston rod out. An external force is required to return the cylinder to the retracted position. A typical application for a single-acting

cylinder is a lift truck, where the load of the fork pushes the cylinder back. Multi-stage cylinders (also referred to as telescoping cylinders) have two or more piston rods in a coaxial arrangement to achieve greater extended length compared to the retracted length.

Fig. 2

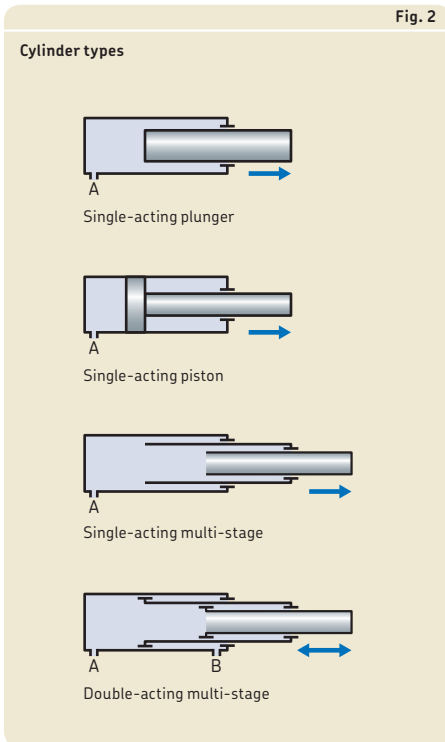

Cylinder classification

The type of cylinder and the application in which it is used are two of the main criteria when selecting the appropriate seals and guides. Applications are referred to as light duty, medium duty or heavy duty applications. These classifications are somewhat subjective but the duty levels are typically characterized by the following criteria.

Light duty cylinders

Light duty cylinders, e.g. cylinders used for stationary equipment indoor in a factory environment, may be characterized by:

- system pressures up to 160 bar (2 300 psi)
- temperatures up to 70 °C (160 °F)
- rare pressure peaks in excess of system pressure
- minimal side loads acting on guides
- environment with moderate temperature fluctuations and relatively free of contaminants

Medium duty cylinders

Medium duty cylinders, e.g. cylinders in agriculture off-highway equipment, may be characterized by:

- system pressures up to 250 bar (3 625 psi)
- temperatures up to 90 °C (195 °F)
- moderate pressure peaks in excess of system pressure
- moderate side loads acting on guides
- environment with temperature fluctuations and typical external contaminants such as dust and moisture

Heavy duty cylinders

Heavy duty cylinders, e.g. cylinders in off-highway earthmoving or forestry equipment, may be characterized by:

- system pressures of 400 bar (5 800 psi) or more
- temperatures exceeding 90 °C (195 °F) with peaks in excess of 110 °C (230 °F)
- regular pressure peaks in excess of system pressure
- heavy side loads acting on guides, usually due to heavy components and/or high accelerations

- tough environment with wide temperature fluctuations and typical harsh external contaminants

Hydraulic seals and guides

Hydraulic cylinder seals are used to seal the opening between various components in the hydraulic cylinder. **Figure 3** shows an example of the seal and guide components of a heavy duty cylinder. There are two main types of hydraulic seals in the system:

- **Dynamic seals**
They seal between components in relative motion. In a hydraulic cylinder the rod sealing system seals dynamic reciprocating motion between the piston rod and head, while the piston sealing system seals dynamic reciprocating motion between the piston and cylinder bore.
- **Static seals**
They seal between components fixed together without relative motion. Hydraulic cylinders use static seals in various locations depending on the design and construction. The most common are static seals between the piston and piston rod and between the head and cylinder bore tube.

Each dynamic seal in a hydraulic cylinder has a special function to contribute to the performance of the system:

Piston seal functions

- act as pressure barrier and prevent fluid passing the piston – important for controlling the cylinder motion or maintaining the position when at rest

Rod seal functions

- act as pressure barrier and keep the operating fluid inside the cylinder
- regulate the fluid film which extends with the surface of the piston rod – important to inhibit rod corrosion and to lubricate the wiper seal and the rod seal itself
- accept the lubrication film back into the cylinder when the rod retracts

Buffer seal functions

- protect the rod seal from fluid pressure peaks in excess of system pressure
- attenuate the fluctuations in system pressure, thereby improving rod seal performance by allowing the rod seal to deal with more constant or gradually changing pressure
- act as an internal excluder to keep system contaminants, such as metal particles, from damaging the rod seal

Wiper seal functions

- exclude external contaminants from entering the cylinder assembly and the hydraulic system
- accept the lubrication film back into the cylinder when the rod retracts

Guide rings (rod and piston) functions

- prevent metal-to-metal contact between components
- react the radial load caused by side loads on the cylinder assembly
- keep the piston rod and piston accurately centred in the cylinder assembly – important for performance of the rod sealing system and piston sealing system

The subsequent chapters contain additional information regarding the function of each seal or guide in the system and the selection of them.

Fig. 3

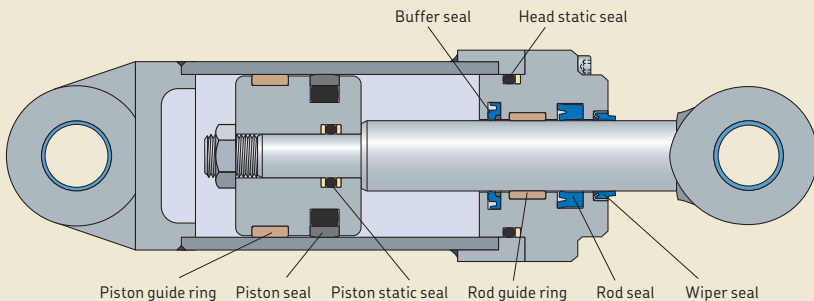

SKF hydraulic seals and guides capabilities

The SKF assortment of hydraulic seals comprises hundreds of different designs and material combinations. The products shown in this catalogue are the more commonly used seal profiles and sizes for hydraulic cylinders. The flexible SKF manufacturing systems and processes, combined with the industry's most agile and comprehensive design and engineering capability, allow additional profiles and sizes to be added on a daily basis. If application requirements are not served by the common profiles or sizes in this catalogue, contact SKF to provide a specific offer.

Customized sealing solutions

In addition to the standard assortment of series-produced seals and sizes listed in this catalogue, SKF designs and manufactures hydraulic seals customized for virtually any requirements.

The design and development of high performance materials combined with testing and failure analysis are vital elements for successful seal development. SKF combines these elements with its extensive application knowledge, to offer solutions that are based on an understanding of sealing systems under various real conditions. SKF continuously develops new customized materials and designs and operates its own testing facilities around the world to provide optimized sealing solutions that meet the sophisticated demands of many industries.

Finite element analysis (FEA)

FEA is used to simulate the impact of operating conditions, material selection and seal design on seal behaviour (→ fig. 4).

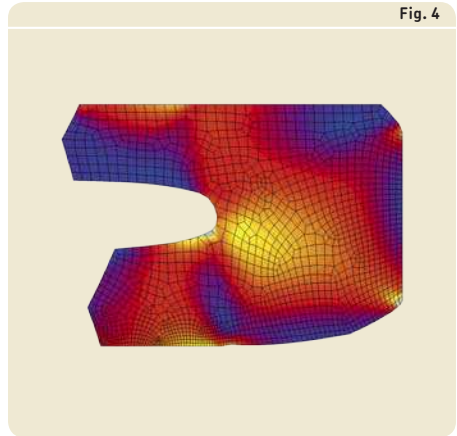

SKF SEAL JET system

With the innovative production system SKF SEAL JET virtually any kind of seal for any conceivable application can be manufactured in any dimension and design. SKF operates more than 200 machining centres worldwide and aims to be located as close to the customer as possible. This reduces manufacturing and dispatch time to a minimum. With local and global application engineering teams supported by research and development centres, machined seals (→ **fig. 5**) produced with SKF SEAL JET machines (→ **fig. 6**) can be customized to meet the most stringent sealing requirements of many industries. Key factors of the SKF SEAL JET systems (→ **fig. 7**) are:

- partnership with customers from the design phase to serial production with customized solutions
- prompt manufacturing of seals and components up to 4 000 mm (157 in.) in diameter as one piece and larger with short delivery times
- diameters up to 10 000 mm (395 in.) and larger by using a special welding technique
- virtually unlimited seal designs
- extensive range of sealing materials including materials certified to or complying with a broad range of industry standards and regulations (FDA, NSF, KTW, NORSOK, NACE, etc.)



Criteria for seal selection

The selection of the right seal profile and material for a given application requires consideration of many factors. This catalogue supports the selection of the right seal for typical hydraulic seal applications and existing cylinder designs. For any application factors outside of the ordinary, or to specify sealing systems in new hydraulic cylinder designs, a certain amount of expertise, beyond the content of this catalogue, may be required. The hydraulic seal experts at SKF can assist in selecting the right sealing system for new cylinder designs.

Before seals can be selected certain application parameters and information should be collected. The following most common application considerations are nearly always required when selecting hydraulic seals:

- fluid pressure range,
the range of operating fluid system pressure, as well as frequency and severity of pressure peaks
- temperature range,
the range of the fluid and cylinder assembly, both when operating and at rest
- speed,
the stroking speed of the reciprocating piston rod
- fluid media,
the type and viscosity of fluid used in the system
- hardware dimensions,
the rod and bore diameters, seal groove dimensions and gaps (if already specified), cylinder overall length and stroke length as well as surface finish specifications (if already specified)
- application of the cylinder,
the type of equipment the cylinder will be used on and how the cylinder will operate in the equipment as well as installation, duty cycles and environmental factors (external temperature, contaminants)



SKF hydraulic seals – general technical information

Specifications for effective sealing systems	22
Counter-surface finish properties	22
Recommendations for dynamic sealing surfaces	24
Recommendations for static sealing surfaces	25
Materials	26
Thermoplastic elastomers	26
Rubbers	27
PTFE	27
Rigid thermoplastics and thermosets	27
Hydraulic fluids	31
Gap extrusion	34
Storage	36
Storage conditions	36
Shelf life	37
Installation and assembly	38
Seal housing grooves	38
Corner radii	39
Groove edge radii	39
Installation chamfers	40
Installing rod seals	40
Installing rod seals in closed grooves	40
Installing piston seals	42
Installing wiper seals	43

Specifications for effective sealing systems

Designing hydraulic rod and piston sealing systems requires careful attention to the dynamic seal interaction and the principles of tribology to ensure long service life, proper seal function, minimal wear, low friction and smooth operation. Tribology is the study of the design, friction, wear and lubrication of interacting surfaces in relative motion. The most important considerations for tribological properties of a dynamic sealing system are:

- the seal material
- the seal profile design
- the counter-surface material and finish properties
- the hydraulic fluid, which is the lubrication for the dynamic sealing surfaces

For information about seal profile design, see the relevant product chapter.

Counter-surface finish properties

The surface properties of the cylinder bore and the piston rod have a great influence on

the function and service life of the seal. Parameters for specifying a surface finish are defined by ISO 4287. The most common surface roughness parameter specified is R_a (in units μm or $\mu\text{in.}$), i.e. the arithmetic mean deviation of the surface profile. This value does not, however, completely describe how the surface can be expected to affect the seal. The reason for this is that two surfaces with the same values of R_a but with different surface profile characteristics can lead to different lubrication film thickness, resulting in varying seal performance and level of wear.

The material ratio curve (Abbott-Firestone curve) provides more information about the surface profile characteristics. It describes the ratio of the material-filled length to the evaluation length at a given cutting depth expressed in percent (\rightarrow fig. 1). The slope at the beginning of the curve represents the peaks in the profile, which are causing initial wear on the seal. The slope at the end of the curve represents the valleys in the profile, which serve as lubricant reservoirs.

Fig. 1

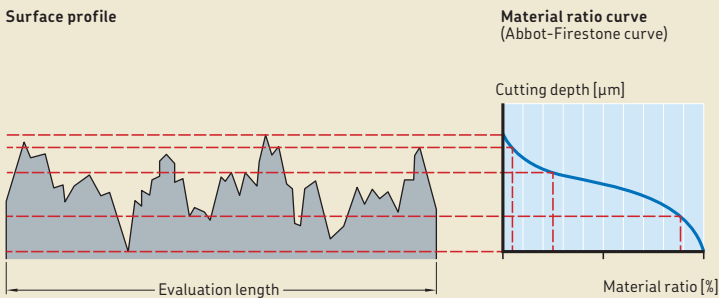

Diagram 1

Table 1 shows some surface profiles. To ensure a surface finish with a suitable profile and characteristics for effective dynamic sealing, SKF recommends a defined combination of the following surface parameters:

- R_a – arithmetic mean roughness
- R_z – mean peak-to-valley height
- R_{max} – maximum peak-to-valley height
- R_{mr} – material ratio at a given depth

SKF recommends evaluating R_{mr} at a cutting depth of $0,5 R_z$ based on $c_{ref} = 0\%$ (→ **diagram 1**).

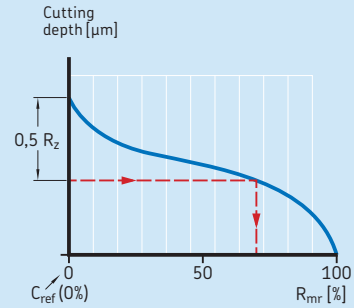

Table 1

Seal counter-surface examples

Surface profile	R_a	R_z	R_{max}	R_{mr}	Material ratio curve
–	μm	μm	μm	%	–
<p>Eroded surface</p>	2,4	7,3	10,4	≈ 40	
<p>Machined surface</p>	2,5	9,5	10,2	≈ 20 ... 25	
<p>Ground and polished surface</p>	0,09	1,2	1,8	≈ 90	

General technical information

Recommendations for dynamic sealing surfaces

The dynamic sealing surfaces on the piston rod and in the cylinder bore (→ **fig. 2**) require similar, but somewhat different surface finishing.

Piston rod

The recommendations for the piston rod sealing surface (→ **table 2**) assume that typical materials and processes are used to manufacture the piston rod by induction hardening a carbon steel rod, grinding, hard-chromium plating and then polishing it to achieve the specified diameter and finish.

For alternative rod materials and coatings, other surface specifications, finishing methods, seal materials and designs may be required. Examples of such alternative rod coatings include:

- various hard metals applied by high velocity oxygen fuel (HVOF)
- ceramic coatings of various compositions and finishes
- stainless steel
- iron nitride

For recommendations for sealing systems with alternative rod materials and coatings, contact SKF.

Table 2

Recommendations for the dynamic sealing surface on piston rods (induction hardened and chrome plated rods)

	Thermoplastics and rubbers	PTFE materials
R_a	0,05 to 0,3 μm (2 to 12 $\mu\text{in.}$)	0,05 to 0,2 μm (2 to 8 $\mu\text{in.}$)
R_z	0,4 to 2,5 μm (15 to 100 $\mu\text{in.}$)	0,4 to 2 μm (15 to 80 $\mu\text{in.}$)
R_{max}	0,4 to 2,5 μm (15 to 100 $\mu\text{in.}$)	
R_{mr}	50 to 95% (cutting depth 0,5 R_z based on $c_{\text{ref}} = 0\%$)	
Hardness	≥ 50 HRC	
Hardening depth	-1,2 to 2,5 mm (-0.05 to 0.1 in.)	
Chromium layer thickness	-20 to 30 μm (-800 to 1 200 $\mu\text{in.}$)	

Fig. 2

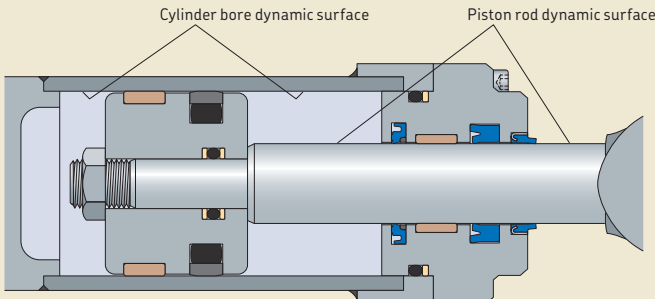

Table 3

Recommendations for the dynamic sealing surface on cylinder bores
(honed or roller burnished tubes)

Thermoplastics, rubbers and PTFE materials

R_a	0,05 to 0,2 μm (2 to 8 $\mu\text{in.}$)
R_z	0,4 to 2 μm (15 to 80 $\mu\text{in.}$)
R_{max}	0,4 to 2,5 μm (15 to 100 $\mu\text{in.}$)
R_{mr}	50 to 95% (cutting depth 0,5 R_z based on $c_{\text{ref}} = 0\%$)

Cylinder bore

The recommendations for the cylinder bore surface (\rightarrow table 3) assume that typical materials and processes are used to machine the bore by either honing or roller burnishing to achieve the specified diameter and finish.

Recommendations for static sealing surfaces

Static sealing surfaces must also have a proper surface finish to enable the desired sealing performance (\rightarrow fig. 3).

The counter-surfaces of static seals exposed to pressure, including the static side of dynamic rod and piston seals, should have a roughness $R_a \leq 0,8 \mu\text{m}$ (30 $\mu\text{in.}$).

Seat diameters of guide rings and wiper seals should have a roughness of $R_a \leq 1,6 \mu\text{m}$ (63 $\mu\text{in.}$). Axial faces of all grooves should have a roughness of $R_a \leq 3,2 \mu\text{m}$ (125 $\mu\text{in.}$).

Fig. 3

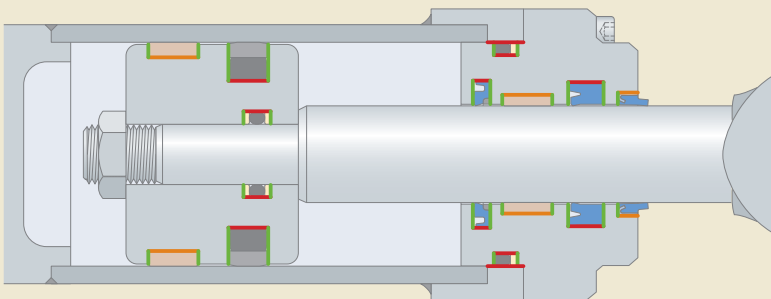

- Counter-surfaces of static seals exposed to pressure
 $R_a \leq 0,8 \mu\text{m}$ (30 $\mu\text{in.}$)
- Seat diameters of guide rings and wiper seals
 $R_a \leq 1,6 \mu\text{m}$ (63 $\mu\text{in.}$)
- Axial faces of all grooves
 $R_a \leq 3,2 \mu\text{m}$ (125 $\mu\text{in.}$)

General technical information

Materials

Materials play a major role in the performance and lifetime of seals. Generally, hydraulic seals are exposed to a variety of application and working conditions, such as a wide temperature range, contact with various hydraulic fluids and the outside environment as well as high pressures and contact forces. The appropriate seal materials have to be selected to achieve a reasonable service life and service intervals. A wide variety of seal materials from four major polymeric material groups is available:

- thermoplastic elastomers, such as polyurethane (TPU) and thermoplastic polyester elastomers (TPC)
- rubbers, such as nitrile rubber (NBR) and hydrogenated nitrile rubber (HNBR), fluoro-carbon rubbers (FKM, FPM)
- polytetrafluoroethylene (PTFE) and its compounds
- rigid thermoplastics and thermosets and their composites

Many different material properties should be considered to support and maintain the sealing function over the expected seal service life, for example:

- good elasticity over a wide temperature range, especially at low temperatures
- excellent compression set and stress relaxation behaviour to keep the sealing force for the requested operating period
- adequate hardness and flexibility to avoid leakage and allow easy installation
- superior gap extrusion resistance to cover the increased pressures of fluid power equipment
- adequate working temperature range
- good chemical compatibility to cover a wide assortment of hydraulic fluids such as mineral and synthetic oils, biodegradable and water-based fluids or fire-resistant fluids
- excellent tribological properties, i.e. low friction values and high wear resistance to achieve a high efficiency and avoid early failures especially when sealing against rough counter-surfaces

In addition to these considerations, the structure and morphology of polymeric materials

make selection and specification of seal materials much more complicated than the standard materials used in mechanical engineering (e.g. aluminium or steel). Mechanical properties of polymeric materials are strongly influenced by time, temperature, load and rate of motion. Highly complex intermolecular processes affect the stress relaxation and retardation phenomena. Furthermore, the tribology conditions of the system (e.g. friction and wear) has a strong influence on the seal material behaviour and vice versa. Therefore, state-of-the-art sealing systems can only be developed by close cooperation between material experts and product designers, supported by advanced design tools like non-linear FEA and extensive seal testing capabilities.

SKF has a global material development organization that closely cooperates with the product development and testing functions. SKF is uniquely suited to develop, simulate, test and manufacture tailor-made materials for specific customer needs.

The following tables list the most common materials used by SKF for serial production of hydraulic seals. A wide variety of additional seal materials are available for special hydraulic seals or other seal applications.

Thermoplastic elastomers

SKF has a long history in developing and supplying special polyurethane grades for sealing purposes. SKF manufactures the well-known ECOPUR family of polyurethanes including H-ECOPUR for outstanding chemical and hydrolysis resistance, X-ECOPUR for extrusion resistance or S-ECOPUR for low friction and resistance to wear.

Polyurethanes combine the elastic properties of elastomers with the processability of thermoplastic materials. Seals made of polyurethanes provide excellent wear and pressure resistance and avoid leakage. Due to their elasticity and flexibility, they are easy to install. Special sealing polyurethane grades have a superior compression set and relaxation performance as well as temperature stability compared to commodity industrial grades.

Table 4 (→ page 28) lists common thermoplastic elastomers.

Rubbers

Rubbers are widely used in the seals industry for rotary shaft seals, static sealing elements such as O-rings and energizers, as well as dynamic seals in the fluid power industry. Depending on the chemical composition, rubbers can cover a wide temperature range up to 200 °C (390 °F) and more and withstand a wide variety of hydraulic fluids. NBR elastomers in a hardness range from 70 to 90 Shore A (shA) are the most commonly used rubbers in the fluid power industry. For higher temperatures and more aggressive hydraulic fluids, SKF recommends HNBR or FKM elastomers.

Table 5 (→ page 29) lists common rubbers.

PTFE

PTFE is a polymer with very unique properties. Due to its chemical composition, it is the plastic material with the highest chemical resistance and the lowest coefficient of friction, however, it has some restrictions in terms of mechanical properties and wear. Therefore, PTFE is very often modified by adding various organic and/or inorganic fillers to improve specific properties such as wear or extrusion resistance.

One of the most important characteristics of PTFE is the low coefficient of friction that provides outstanding start-up behaviour as well as minimized stick-slip phenomenon. Therefore, PTFE is the preferred material in applications that require accurate positioning of hydraulic cylinders. Due to the increased modulus of elasticity compared to rubbers and polyurethanes, PTFE seals can usually not be installed by simple snap-in procedures and require special tools and procedures for installation.

Table 6 (→ page 29) lists common PTFE materials.

Rigid thermoplastics and thermosets

Rigid thermoplastics and thermosets and their composites are characterized by much higher hardness and stiffness as well as reduced elasticity compared to polyurethanes, rubbers or PTFE. Therefore, they are used for components where mechanical strength is more important than flexibility, such as guide rings, anti-extrusion rings or special piston seal arrangements for heavy duty applications.

SKF offers rigid thermoplastics and composites in a wide variety of homogenous (unfilled or “virgin”) grades (e.g. polyacetal or polyamide), filled grades (e.g. glass fibre reinforced PA) and fabric-reinforced composites (e.g. phenolic resin with cotton fabric, PF). For extreme conditions, SKF can provide high performance materials such as PEEK (polyetheretherketone).

Table 7 (→ page 30) lists common rigid thermoplastic and thermosets.

WARNING

At temperatures above 300 °C (570 °F) all fluoro elastomers and PTFE compounds give off dangerous fumes. If there is contact with your skin or if the vapours are inhaled, seek medical advice immediately.















Table 4

Thermoplastic elastomers (TPU and TPC)

Material code	Material description	Hardness		Colour ¹⁾	Example uses
		Shore A (shA)	Shore D (shD)		
LUBRITHANE U-1003	TPU	95		 black	Rod seals, piston seals, wiper seals
LUBRITHANE U-1004	TPU		55	 black	Wiper seals
LUBRITHANE U-1023	TPU	93		 blue	Rod seals, buffer seals, piston seals, wiper seals
LUBRITHANE U-1029	TPU	94		 light blue	Rod seals, buffer seals, piston seals, wiper seals
PU54/199	TPU	97	54	 blue	Piston seal slide rings
W93	TPU	93		 white	Press-in wiper seals
Y95A	TPU	95		 yellow	Back-up rings for O-rings
395A	TPU	98		 black	Back-up rings for O-rings
B93	TPU	93		 dark blue	Rod seals
ECOPUR	TPU	95	48	 green	Premium U-cup seals, wiper seals and chevron packings
X-ECOPUR	TPU with increased hardness and extrusion resistance	97	57	 dark green	Rod and buffer seals
X-ECOPUR PS	TPU with increased hardness and extrusion resistance	98	60	 green	Piston seals for heavy duty hydraulic applications
H-ECOPUR	TPU with increased chemical resistance against biodegradeable and water based fluids	95	48	 red	Rod and piston seals for applications requiring hydrolysis resistance, increased chemical resistance or conformance with FDA regulations
XH-ECOPUR	TPU with increased chemical resistance and higher hardness	97	60	 dark red	Rod and piston seals for applications requiring hydrolysis resistance, increased chemical resistance or conformance with FDA regulations
S-ECOPUR	TPU with improved tribological characteristics	95	48	 dark grey	Rod and piston seals for water hydraulics, non-lubricated pneumatics or dry-running conditions
FLUOROTREL F-1504	TPC		55	 turquoise	Energized rod seals, piston seals, anti-extrusion rings
TPC-ET72/075	TPC		72	 black	Piston seal support rings





¹⁾ The colour examples may deviate from the actual colour of the material.

Table 5

Rubbers				
Material code	Material description	Hardness Shore A	Colour ¹⁾	Example uses
A-8501	NBR	70	 black	Rod seals, piston seals, energizers
A-8504	NBR-LT (low-temperature grade)	70	 black	Rod seals, piston seals, energizers
A-8526	NBR	90	 black	Piston seal energizers
C-7021	HNBR	70	 black	Rod seals, piston seals, energizers
C-7022	HNBR	80	 black	Rod seals, piston seals, energizers
V-7501	FKM	70	 black	Piston seals
V-7503	FKM	90	 black	Rod seals, piston seals, energizers
N70/015	NBR	70	 black	Piston seal energizers
N70/6052	NBR	70	 black	O-rings and energizers
N80/047	NBR	80	 black	Piston seals
N80/198	NBR	80	 black	Energizers for heavy duty applications
SKF Ecorubber-1	NBR	85	 black	U-cup seals, chevron packings, machined seals
SKF Ecorubber-2	FKM	85	 brown	U-cup seals, machined seals, chevron packings, wiper seals
SKF Ecorubber-H	HNBR	85	 black	U-cup seals, chevron packings, machined seals

¹⁾ The colour examples may deviate from the actual colour of the material.

Table 6















PTFE materials				
Material code	Material description	Hardness Shore D	Colour ¹⁾	Example uses
292	PTFE + 40% bronze + MoS ₂	62	 brown-grey	Piston seal slide rings, guide strips
SKF Ecoflon 1, 100	PTFE unfilled	57	 white	Anti-extrusion rings, chevron sets, O-rings, food-compatible products (FDA certificate)
SKF Ecoflon 2, 702	PTFE + 15% glass fibres + 5% MoS ₂	60	 grey	Anti-extrusion rings, chevron sets, O-rings
SKF Ecoflon 3, 741	PTFE + 40% bronze	65	 brown	Anti-extrusion rings, chevron sets, O-rings
SKF Ecoflon 4	PTFE + 23% hard carbon + 2% graphite	65	 black	Anti-extrusion rings, chevron sets, O-rings

¹⁾ The colour examples may deviate from the actual colour of the material.

General technical information

Table 7

Rigid thermoplastics and thermosets

Material code	Material description	Colour ¹⁾	Example uses
707	PA 6	 black	Anti-extrusion rings
P-2501	PA 6.6 + 30% glass fibres	 black	Split piston seal slide rings
P-2506	PA 6.12	 black	Anti-extrusion rings
P-2518	POM	 black	Anti-extrusion rings
P-2551	PA 6 + 40% glass fibres	 dark grey	Guide rings and split piston seal slide rings
P-2552	PA 6 + 40% glass fibres + PTFE	 black	Guide rings
PA66/011	PA 6.6 + 20% glass fibres	 black	Split piston seal slide rings
POM/076	POM	 red	Guide rings in compact sets (light and medium duty cylinders)
PF	Phenolic resin with cotton fabric	 brown	Guide rings
SKF Ecomid	PA 6	 black	Anti-extrusion rings, guide rings
SKF Ecotal, 728	POM	 black	Anti-extrusion rings, guide rings and scraping wiper seals
SKF Ecopaek	PEEK	 beige	Anti-extrusion rings, guide rings
SKF Ecowear 1000	UHMWPE (ultra-high-molecular-weight polyethylene)	 white	Anti-extrusion rings, guide rings
SKF Ecotex	Polyester resin with polyester fabric and graphite filler	 light orange	Guide rings

¹⁾ The colour examples may deviate from the actual colour of the material.

Hydraulic fluids

Fluids used in hydraulic systems serve multiple functions for the system performance:

- transfer power by flow under pressure acting on moveable parts
- lubricate surfaces in contact and relative motion – hydraulic cylinder components and seals, as well as other system components such as pumps and valves
- prevent corrosion of components
- cool the system, by carrying heat from areas of high load, motion or turbulence and spread it to the entire volume of the system including reservoir tanks and cooling equipment
- clean the system by carrying contaminants and wear particles to filter bodies or settling areas

The fluids used in hydraulic systems come in various chemical compositions and viscosity grades as suited to specific applications.

Viscosity is a measurement of the thickness of a fluid or the resistance to flow. Seal performance is affected by the viscosity of the fluid and changes to the viscosity during use. Most typical hydraulic fluids exhibit decreased viscosity with increasing temperature and increased viscosity with increasing pressure.

The most commonly used media in hydraulic systems are mineral oil based fluids with various additives. However, a variety of alternative fluids may be encountered in special applications. For example, biodegradable fluids such as synthetic (HEES) or natural esters (HETG) and polyalphaolefines (PAO) may be used to reduce environmental impact in the event of accidental spills. Flame retardant fluids based on water or synthetic esters may be safely used in confined spaces or where the hydraulic system is used in close proximity to ignition sources. The data, specifications and recommendations in this catalogue are for common mineral oil fluids. For guidance on specifications of sealing systems for alternative fluids, contact SKF.

The chemical composition of hydraulic fluids can impact the seal life and performance depending on compatibility with the seal material(s). Absorption and reaction of the seal material(s) with non-compatible fluids can cause, for example:

- changes in seal material volume – increased “swelling” or decreased “shrinking” and their respective impacts on seal contact force and friction
- hardening and embrittlement of the seal material
- softening, loss of strength or dissolving of the seal material
- degradation of the polymer chains or cross-linking, causing the material to fatigue or lose resilience
- discoloration of the seal material

Generally, these changes are accelerated by higher temperature. To avoid these changes and the resulting damage to seal function and life, careful consideration should be taken to ensure compatibility between the fluid and all seal materials, as well as the temperature and mechanical loads on the seal material. SKF has a long history and extensive database of test results concerning compatibility of various seal materials and fluids, as well as unparalleled expertise in developing materials to meet customers' needs for chemical resistance of seal materials.

Table 8 (→ page 32) summarizes the compatibility rating for the most important fluids and materials used in the fluid power industry. For materials not listed, contact SKF. **Table 8** provides general guidelines for new, clean fluids. Fluids vary by manufacturer, additives and contaminant levels. Materials vary by specific compound. The guidelines cannot substitute for testing the compatibility of a seal in the actual fluid and under actual operating conditions. Temperatures higher than specified in **table 8** can lead to degradation of the basic fluid or its additives. This can cause deterioration of the seal material. For applications where higher temperatures are required, contact SKF.

In addition to the specified hydraulic fluid, seal materials can be attacked by exposure to other fluids from other parts of the machinery (e.g. greases, fuels, coatings), environmental factors (e.g. humidity or radiation) and degradation and reaction with the fluids, additives and contaminants in the system producing additional chemicals.

General technical information

Hydraulic fluids and seal material compatibility

Fluids	Thermoplastic elastomers								
	ECOPUR, LUBRITHANE				H-ECOPUR, XH-ECOPUR		Ether-based TPU		TPC (≥ 95 shA)
	Temperature Normal High		Normal High		Normal	High	Normal	High	
Hydraulic fluids	≤ 60 °C (≤ 140 °F)	≤ 100 °C (≤ 210 °F)	≤ 60 °C (≤ 140 °F)	≤ 100 °C (≤ 210 °F)	≤ 60 °C (≤ 140 °F)	≤ 100 °C (≤ 210 °F)	≤ 60 °C (≤ 140 °F)	≤ 100 °C (≤ 210 °F)	
Mineral oils HL, HLP, HVLP	A	B	A	A	A	B/C	A	A/B	
ATF (automatic transmission fluids)	A	B	A	A	A	B/C	A	B	
HETG (triglycerides, rape seed oil)	A	B/C	A	A	A	C	A	B/C	
HEES (synthetic esters)	A	B/C	A	A	A	C	A	B/C	
HEPG (polyalcyline glycols)	B	D	A	C	B/C	D	C	D	
HEPR (polyalphaolefines)	A	B	A	A	A	B/C	A	B	
Fire resistant fluids, water-based	≤ 40 °C (≤ 105 °F)	≤ 60 °C (≤ 140 °F)	≤ 40 °C (≤ 105 °F)	≤ 60 °C (≤ 140 °F)	≤ 40 °C (≤ 105 °F)	≤ 60 °C (≤ 140 °F)	≤ 40 °C (≤ 105 °F)	≤ 60 °C (≤ 140 °F)	
Water	B	D	A	A	A	B	A	B	
HFA-fluids (oil in water)	B	D	A	A	B	B/C	A	B	
HFB-fluids (water in oil)	B	D	A	A	B	D	A	B	
HFC-fluids (water-glycol)	C	D	A	B/C	B	B/C	C	D	
Fire resistant fluids, water-free	≤ 60 °C (≤ 140 °F)	≤ 100 °C (≤ 210 °F)	≤ 60 °C (≤ 140 °F)	≤ 100 °C (≤ 210 °F)	≤ 60 °C (≤ 140 °F)	≤ 100 °C (≤ 210 °F)	≤ 60 °C (≤ 140 °F)	≤ 100 °C (≤ 210 °F)	
HFD-R fluids	D	D	D	D	D	D	D	D	
HFD-U fluids (polyol and carboxylic esters)	B	D	A	A	B	D	A	B/C	
Mineral greases	A	B	A	A	A	B	A	A	
	A	Excellent							
	B	Good							
	C	Limited							
	D	Not recommended							

1) Ethylene-propylene rubber for reference only – not common for hydraulic cylinders

2) For filled PTFE, compatibility of filler must be considered separately (e.g. bronze not recommended for water-based fluids).

3) Exposure to water-based fluids or moisture causes swelling.

4) Contact SKF

Table 8

1

Rubbers		FKM			EPDM ¹⁾	Thermoplastics and thermosets			PTFE ²⁾
NBR, HNBR					PA, PF	POM	PEEK		
Temperature		Normal	High	All	Temperature			All	
Normal	High				All	All	All	All	

$\leq 60\text{ }^{\circ}\text{C}$ ($\leq 140\text{ }^{\circ}\text{F}$)
 $\leq 100\text{ }^{\circ}\text{C}$ ($\leq 210\text{ }^{\circ}\text{F}$)
 $\leq 60\text{ }^{\circ}\text{C}$ ($\leq 140\text{ }^{\circ}\text{F}$)
 $\leq 100\text{ }^{\circ}\text{C}$ ($\leq 210\text{ }^{\circ}\text{F}$)

A	A	A	A	D
A	A	A	A	D
A/B	A/B	A	A	D
A/B	A/B	A	A	D
A	A/B	A/B	C/D	A
A/B	A/B	A	A	D

A	A	A	A
A	A	A	A
A	A	A	A
A	A	A	A
A	A	A	A
A	A	A	A

$\leq 40\text{ }^{\circ}\text{C}$ ($\leq 105\text{ }^{\circ}\text{F}$)
 $\leq 60\text{ }^{\circ}\text{C}$ ($\leq 140\text{ }^{\circ}\text{F}$)
 $\leq 40\text{ }^{\circ}\text{C}$ ($\leq 105\text{ }^{\circ}\text{F}$)
 $\leq 60\text{ }^{\circ}\text{C}$ ($\leq 140\text{ }^{\circ}\text{F}$)

A	A	A	A	A
A	A	A	B	D
A	A	A	A	D
A	A	A/B	B/C	A

C ³⁾	A	A	A
C ³⁾	A	A	A
C ³⁾	A	A	A
C ³⁾	A	A	A

$\leq 60\text{ }^{\circ}\text{C}$ ($\leq 140\text{ }^{\circ}\text{F}$)
 $\leq 100\text{ }^{\circ}\text{C}$ ($\leq 210\text{ }^{\circ}\text{F}$)
 $\leq 60\text{ }^{\circ}\text{C}$ ($\leq 140\text{ }^{\circ}\text{F}$)
 $\leq 100\text{ }^{\circ}\text{C}$ ($\leq 210\text{ }^{\circ}\text{F}$)

D	D	A/C ⁴⁾	A/C ⁴⁾	A
A/B	C	A	A	D

A	A	A	A
A	A	A	A

A	A	A	A	D
---	---	---	---	---

A	A	A	A
---	---	---	---

Gap extrusion

The process by which seal material is forced into the clearances between components is called gap extrusion. The dimension of this clearance gap is referred to as the extrusion gap, or “e-gap” (→ fig. 4).

The resistance of a given seal component to gap extrusion is mainly determined by the material composition and quality. Materials of greater hardness and stiffness typically also have improved resistance to extrusion. Therefore, full-face anti-extrusion or back-up rings of materials harder than the seal material may be used to prevent seal extrusion into the e-gap (→ fig. 5).

Pressure is the main driver of extrusion, but the e-gap size and application temperature are also major factors. **Diagram 2** shows the pressure resistance of different materials as a function of temperature. The values were measured on an SKF test rig. The tests were carried out with a rectangular sample, dimensions 38,7 x 49 x 5 mm under static pressure and an extrusion gap of 0,3 mm. The pressure values were taken at an extrusion length of 0,5 mm (→ fig. 4). While these sample values illustrate the differences in extrusion resistance for standard grades of typical seal materials, there are many variations of each basic composition that impact the extrusion resistance of seals. In addition, the profile design and the seal friction affect extrusion. For maximum allowable pressure, temperature and e-gap of each seal profile, refer to the profile data for each profile in the relevant chapters.

The maximum e-gap in a hydraulic cylinder occurs when the cylinder components are at the maximum radial misalignment of components. This misalignment is affected by:

- external forces acting upon the cylinder assembly (e.g. acceleration forces, frictional moments from rotation of cylinder end connections)
- the weight of the cylinder components (especially when used horizontally)
- deformation of cylinder components (rod flexing, guide ring radial deformation under force)
- the tolerance stack up of multiple cylinder components

Fig. 4

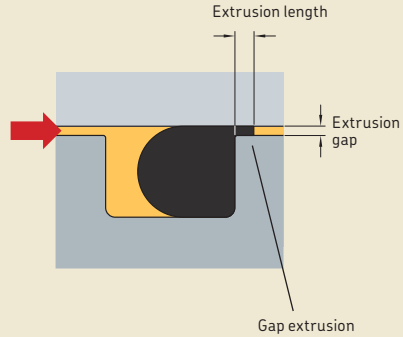

Fig. 5

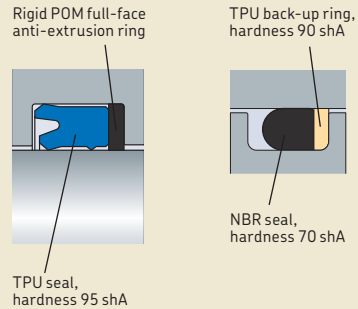

Diagram 2

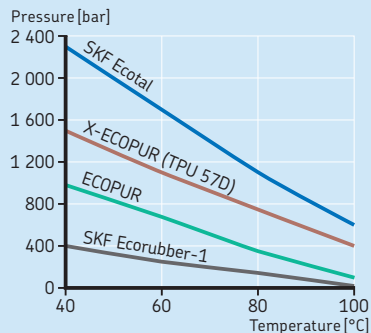
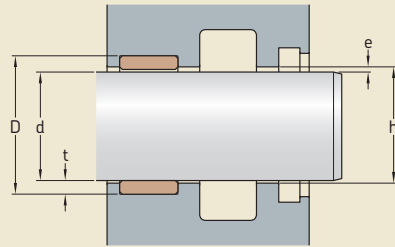

Fig. 6



Therefore, it is necessary to calculate the e-gap at the maximum misalignment at minimum material conditions of the cylinder and guide components.

For rod seals, the maximum e-gap should be calculated with the following conditions (→ **fig. 6**):

- guide ring groove at maximum diameter D
- rod at minimum diameter d
- guide ring cross section at minimum thickness t (considering tolerances and any radial deformation of the guide ring under load)
- rod seal housing throat at maximum diameter h

For piston seals, the maximum e-gap should be calculated with the following conditions (→ **fig. 7**):

- bore at maximum diameter D
- guide ring groove at minimum diameter d
- guide ring cross section at minimum thickness t (considering tolerances and any radial deformation of the guide ring under load)
- piston seal housing at minimum outside diameter OD

The maximum allowable e-gap is provided in the profile data for each rod seal and piston seal profile in the relevant chapter. The e-gap can be kept within these limits by specifying and controlling the tolerances of dimensions described above and shown in **figs. 6 and 7**.

Fig. 7

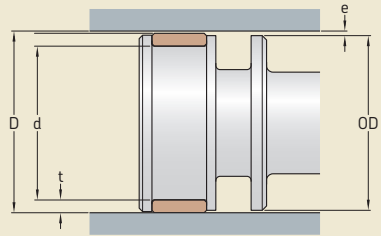

Storage

During storage, the properties of elastomer products can be damaged either by chemical reactions or by physical processes. Chemical reactions are basically caused by the influence of heat, light, oxygen, ozone or contamination by chemicals. The physical processes, which are called physical ageing, are either due to the influence of external stresses leading to cracks and permanent deformation, or due to the migration of plasticizers, which makes the material more brittle and can lead to deformation of the parts.

Therefore, elastomer products only maintain their characteristics for several years without major changes, if they are properly stored. The ageing behaviour of elastomer products and their reaction on storage conditions depend considerably on their chemical structure. Unsaturated elastomers (e.g. nitrile rubber) age more quickly under improper storage conditions than saturated elastomers (e.g. fluorocarbon rubber).

Storage conditions

Elastomer products should be stored in accordance with the following recommendations, which are in line with the recommendations provided in ISO 2230 or DIN 7716.

- Rubber and plastic products should be stored in a cool and dry room. The relative humidity should be < 65%. Storage temperature should be around 15 °C (60 °F) and not exceed 25 °C (75 °F). If the storage temperature is below 15 °C (60 °F), care should be taken during handling of stored products because they may have stiffened. They should be warmed up slowly at ambient temperature.
- The storage room must not contain any ozone-producing devices, such as electric motors or high-voltage devices.
- Rubber and plastic products should not be exposed to direct sunlight or artificial light with a high UV content (bulbs are preferred to neon lamps).
- Rubber products should not be exposed to drafts. They should be stored in airtight packaging. The package material must not contain plasticizers. Polyethylene is the most suitable package material.
- Contact between rubber products of different compositions should be avoided.
- Contact between rubber and plastic products and chemicals or dangerous metals (e.g. copper, manganese) should be avoided.
- Rubber and plastic products should be stored as tension-free as possible, i.e. the parts should not be subject to tension, pressure or bending. Rubber products, especially seals, must not be hung on nails or tightly folded or rolled for reasons of space.

Shelf life

When stored under the conditions mentioned above, elastomer products retain their typical properties for several years (→ **table 9**).

The typical shelf life may be prolonged based on the actual product conditions at the end of the typical shelf life. Trained and experienced experts can approve a prolonged storage period based on a visual inspection of representative samples. The samples should not reveal any permanent distortion, mechanical damage or surface cracking. The material should not show any signs of hardening or softening nor any kind of tackiness.

Table 9

Shelf life recommendations in years

Material	Typical shelf life	Possible prolongation
TPU (standard)	5	2
ECOPUR, LUBRITHANE	5	2
H-ECOPUR, XH-ECOPUR	10	2
TPC	5	2
NBR	6	3
HNBR	8	4
FKM, FPM	10	4
EPDM	8	4
MVQ (silicone)	10	5
PTFE	15	5
PA, POM, PF	8	4
PEEK	15	5
UHMWPE	10	5

Installation and assembly

Seal housing grooves

The type of seal housing determines the method of installation, required equipment and the degree of difficulty. There are four main types of seal housings.

Closed housing grooves

Closed housing grooves are the most common seal housings (→ **fig. 8**). They require the most planning and effort to ensure that the seal is installed properly without damage. Not all seal cross section sizes and material combinations can be installed into this type of seal housing.

Open housing grooves

Open housing grooves allow the seal to be pressed in with minimal deformation and are therefore a good choice when the seal design, material or size prevent installation into a closed or stepped housing. Some seals, such as press-in wiper seals, have a metal sleeve that retains the seal in an open groove by press forces (→ **fig. 9**), whereas other seals may require a snap ring (→ **fig. 10**). Plastic snap rings, such as RI for rods or RR for piston, are available from SKF on request. Open housing grooves require specified edge radii or chamfers to prevent seal damage when the seal enters the housing groove or passes the snap ring groove.

Fig. 8

Closed housing groove

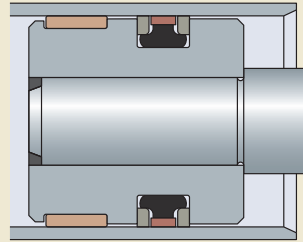

Fig. 9

Open housing groove



Fig. 10

Open housing groove with snap ring

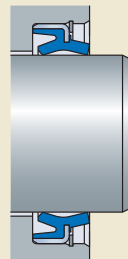

Fig. 11

Split two-piece closed grooves

These grooves incorporate two separable machine components to provide an open groove when the seal is installed and a closed groove when the machine is fully assembled (→ fig. 11).

Stepped grooves

Stepped grooves allow seals to be installed with less deformation (→ fig. 12). Snap-in wiper seals are a common example in hydraulic cylinder applications.

Corner radii

The corner radii inside the groove should be sized to avoid inadvertent contact with the adjacent portion of the seal. Static side corner radius recommendations are provided in the product tables of the relevant chapter.

Groove edge radii

All outside groove edges and any other edges that may come into contact with the seal during installation or use should be broken with a small radius. Otherwise, the sharp edge may damage the seal. Unless otherwise specified, all outside groove edges should have a radius of approximately 0,2 mm (0.008 in.).

Split two-piece closed housing groove

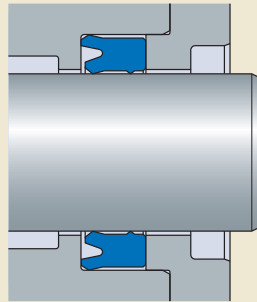
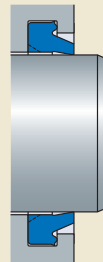

Fig. 12

Stepped housing groove



General technical information

Installation chamfers

Installation chamfers should be designed into the cylinder bore and onto the assembly end of the piston rod to ensure that the seal can easily transition from its free state diameter into its installed diameter. The installation chamfer should also be blended into the cylinder bore or piston rod diameter with a generous radius. The chamfer angle and minimum length recommendations are provided in the product tables of the relevant chapter.

Installing rod seals

The method of installation and the possible groove types for rod seals depend on the materials, seal design and ratio between the diameter and cross-sectional height. **Table 10** provides general recommendations for profiles made of rubber or TPU with a hardness ≤ 95 shA. PTFE or other harder materials may require a smaller radial depth S or even open grooves. The recommendations in **table 10** are not a substitute for careful installation tests in the particular application.

Installing rod seals in closed grooves

Rod seals can often be installed into closed grooves through carefully bending the profile similar to a kidney shape and then inserting it into the groove. It is very important to avoid sharp bending.

Thin and flexible profiles can be installed by hand (\rightarrow **figs. 13 a** and **b**). Installation tools for TPU rod seals help to install profiles of greater section thickness (\rightarrow **figs. 14 a** to **f**). After installation, the seal may need to be reshaped to a round form using a cone-shaped tool.

For PTFE seals, small diameter seals or for serial assembly, special assembly tools (\rightarrow **fig. 15, page 42**) may be required to save time or avoid seal damage. For additional information about such special installation tools, contact SKF.

Table 10

General recommendations for selecting the type of installation for rubber and TPU materials (hardness ≤ 95 shA)

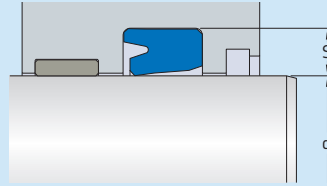

Diameter/radial depth ratio	Type of installation
-----------------------------	----------------------

$d/S \leq 6$	Open groove
$6 < d/S \leq 10$	Closed groove, installation with tool
$d/S > 10$	Closed groove, installation by hand

Fig. 13 a

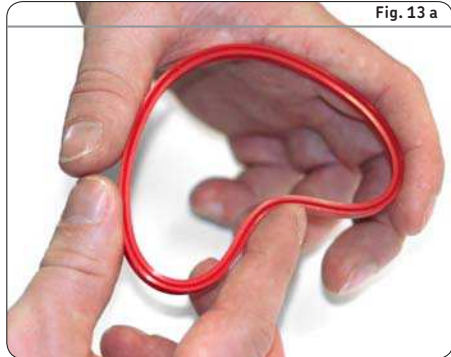
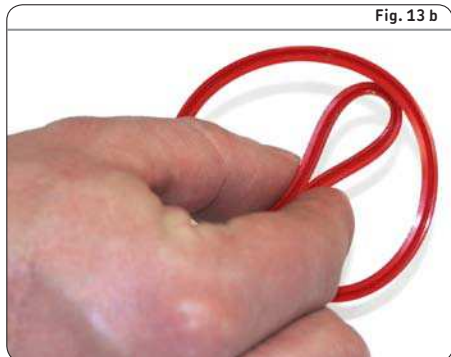

Fig. 13 b



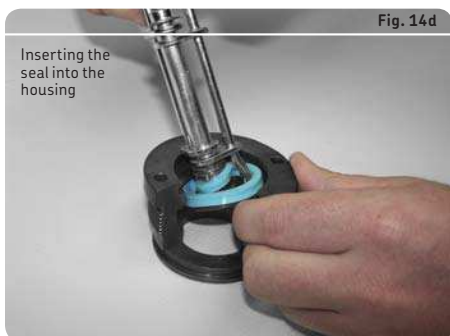
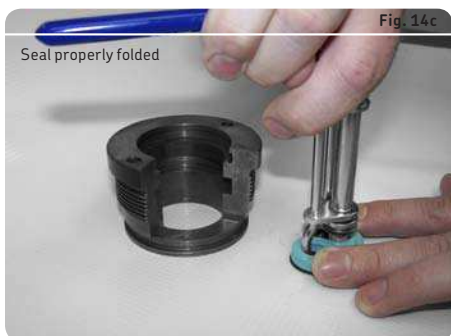
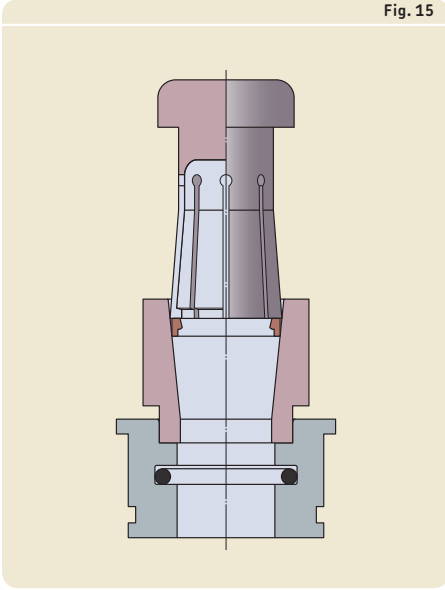

Fig. 15



Installing piston seals

Piston seals installed in closed grooves must be expanded or stretched into position. Seals with step cut slide rings such as CUT or SCP (→ *Piston seals with rigid split slide rings*, page 54) are relatively easy to expand into position. Non-split profiles should not be expanded to a material deformation of more than 20% for TPU or 30% for rubbers. Otherwise, the permanent deformation would be too large. Heating the seal, e.g. in an oil bath, decreases the required expansion force, but cannot increase the maximum material deformation.

Piston seals with a TPU slide ring can usually be installed by hand or with simple tools (→ fig. 16). PTFE seals or those with thicker radial sections may require special assembly tools to save time or avoid seal damage (→ fig. 17). For additional information about such special installation tools, contact SKF.

The recommendations cannot substitute for careful installation tests in the particular application.

Fig. 16

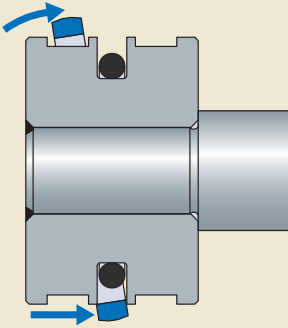
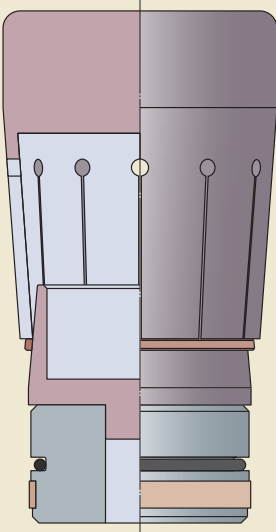

Fig. 17



Installing wiper seals

Snap-in wiper seals, which are installed in stepped grooves (→ **fig. 12, page 39**), are typically of a small radial section per diameter and close to the end of the cylinder head component. Therefore, installation by hand is usually possible.

Press-in wiper seals require special equipment and careful planning for ease of installation without damaging the wiper seal or housing. Assembly tools adapted for each press-in wiper seal size should be used in conjunction with appropriate steady force in a hand operated press. Installation by impact (e.g. striking the assembly tool with a hammer) is not advised. The press assembly tool should be configured to stop when the wiper seal has been pressed flush with the groove edge (→ **fig. 18**). Pressing beyond flush can damage the wiper seal.

Fig. 18

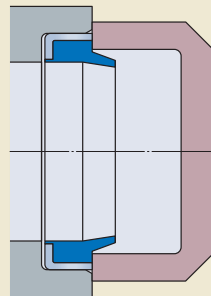

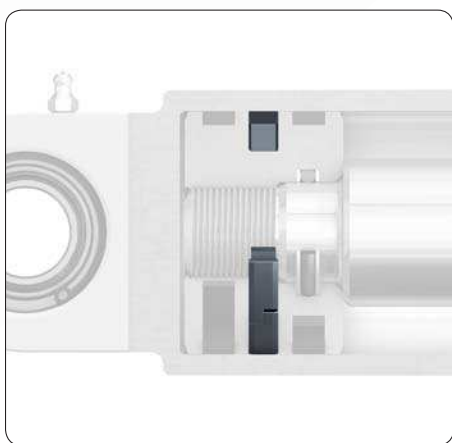
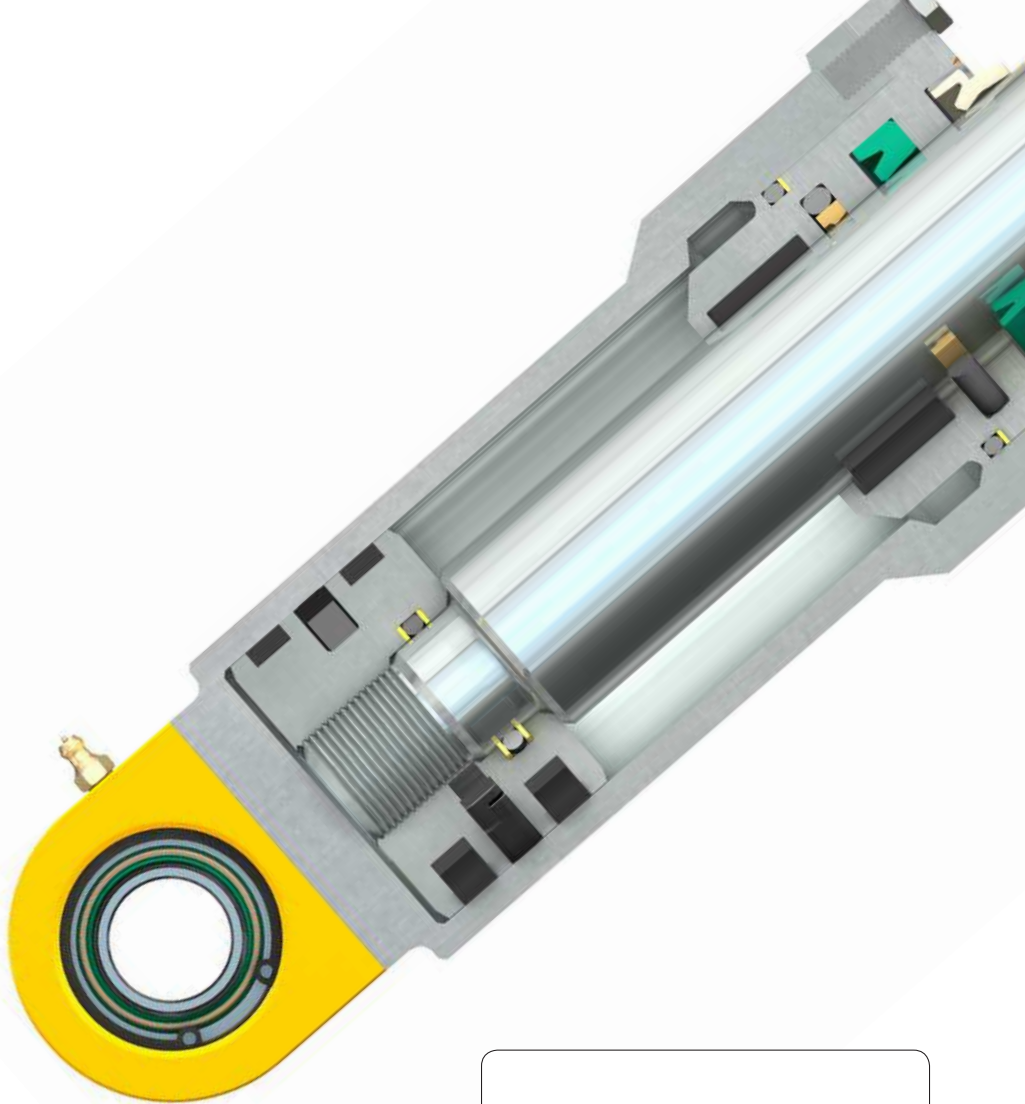





Piston seals



Profile overview	46	Profile data	
Basics	48	2.1 MPV	58
Materials	48	Metric sizes	59
Gap extrusion	48	2.2 DPV	60
Piston guidance	48	Inch sizes	61
Piston drift	49	2.3 LPV	62
Sealing between piston and rod	49	Metric sizes	63
Double-acting piston seals	50	2.4 CPV	64
Piston seals with polyurethane		Inch sizes	65
slide rings	50	2.5 GH	66
MPV profiles	50	Metric sizes	67
DPV profiles	51	Inch sizes	70
LPV profiles	51	2.6 APR	76
CPV profiles	51	Metric sizes	77
Piston seals with PTFE slide rings	52	Inch sizes	79
GH profiles	52	2.7 LCP	82
APR profiles	52	Metric sizes	83
Piston seals incorporating		Inch sizes	85
anti-extrusion rings	53	2.8 LTP	86
LCP profiles	53	Inch sizes	87
LTP profiles	53	2.9 CUT	90
Piston seals with rigid split slide rings	54	Metric sizes	91
CUT profiles	54	2.10 SCP	94
SCP profiles	54	Inch sizes	95
Piston seals with integrated guide rings		2.11 MD-L	98
MD-L profiles	55	Metric sizes	99
Single-acting piston seals	56	2.12 UNP	102
UNP profiles	56	Metric sizes	103
Single-acting piston seals in		Inch sizes	105
double-acting cylinders	56	More piston seals	108
Rod seals used as single-acting		More PTFE slide ring piston seals	108
piston seals	56	SPECTRASEAL	108
		Customized machined seal profiles	108

Profile overview

Profile	Description	Additional information → page	Profile data → page
MPV 	Polyurethane slide ring, nitrile rubber energizer; suitable for medium to heavy duty applications	50	58 (metric)
DPV 	Polyurethane slide ring, nitrile rubber energizer; fits O-ring dash-number housings; suitable for medium to heavy duty applications	51	60 (inch)
LPV 	Polyether-based polyurethane slide ring, nitrile rubber energizer; suitable for light to medium duty applications	51	62 (metric)
CPV 	Polyurethane slide ring, nitrile rubber energizer; fits O-ring dash-number housings; suitable for light to medium duty applications	51	64 (inch)
GH 	PTFE slide ring, nitrile rubber energizer; low breakaway friction; suitable for medium duty applications	52	66 (metric and inch)
APR 	PTFE slide ring with incorporated nitrile rubber X-ring for improved sealing performance, nitrile rubber energizer; suitable for medium to heavy duty applications	52	76 (metric and inch)
LCP 	PTFE slide ring supported by polyamide anti-extrusion rings, nitrile rubber energizer; very good gap extrusion resistance; suitable for heavy duty applications and high pressures	53	82 (metric and inch)
LTP 	Sealing ring made of nitrile rubber, supported by polyamide anti-extrusion rings; good gap extrusion resistance; fits O-ring dash-number housings; suitable for medium to heavy duty applications and high pressures	53	86 (inch)

Profile	Description	Additional information → page	Profile data → page
CUT 	Step cut polyamide slide ring, nitrile rubber energizer; suitable for heavy duty applications and high pressures	54	90 (metric)
SCP 	Step cut polyamide slide ring, oval nitrile rubber energizer; fits wide, shallow inch size housings; suitable for heavy duty applications and high pressures	54	94 (inch)
MD-L 	Five-piece compact set consisting of a nitrile rubber sealing ring, integrated polyester elastomer anti-extrusion rings and polyacetal guide rings; suitable for medium duty applications	55	98 (metric)
UNP 	Polyurethane U-cup profile; single-acting; may be used in double-acting cylinders when using two seals in back-to-back arrangement; suitable for medium duty applications	56	102 (metric and inch)

Rod seals that can be used as piston seals

PTB 	These rod seal profiles are designed with similar inside and outside sealing geometry. Therefore, they can also be used as piston seals (→ <i>Rod seals used as single-acting piston seals</i> , page 56).	→ <i>Rod and buffer seals</i> , page 111	138 (metric and inch)
STD 			164 (inch)
DZ 			178 (metric and inch)

Basics

Piston seals (→ **fig. 1**) maintain sealing contact between the piston and the cylinder bore. Differential pressures acting on the piston to extend or retract the piston rod can be in excess of 400 bar (5 800 psi). The pressure acting on the piston seal increases contact forces between the piston seal and cylinder surface. Therefore, the surface properties of the sealing surfaces are critical to proper seal performance (→ *Counter-surface finish properties*, **page 22**).

Piston seals are typically classified into single-acting (pressure acting on one side only) and double-acting (pressure acting on both sides) seals.

Materials

Depending on the profile and the required characteristics of its components, a piston seal can consist of one or several materials. Common materials used for piston seals are thermoplastic polyurethane (TPU), polytetrafluoroethylene (PTFE), polyamide (PA), and nitrile rubber (NBR). The standard materials used for a specific profile are provided in the *Profile overview* (→ **page 46**) and in the relevant profile sections below.

For additional information, refer to *Materials* (→ **page 26**).

More information

Counter-surface finish properties	22
Materials	26
Hydraulic fluids	31
Gap extrusion	34
Storage	36
Installation and assembly	38

Fig. 1

Typical piston seal arrangement for double-acting cylinders

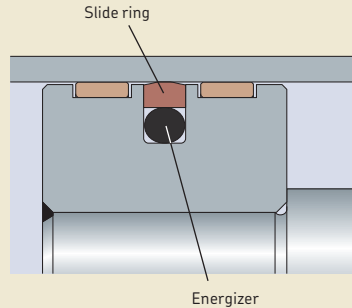

Gap extrusion

External forces acting on the piston rod, reacted by the fluid inside the cylinder, can result in abrupt pressure peaks. These peaks can be far in excess of the system operating pressure and may press a piston seal into the gap between the piston and bore, thereby causing damage to the seal and adversely affecting seal performance and cylinder operation. Seal materials must be carefully chosen to avoid gap extrusion (→ *Gap extrusion*, **page 34**). This risk of gap extrusion can also be minimized by using seals with anti-extrusion rings (→ *Piston seals incorporating anti-extrusion rings*, **page 53**).

Piston guidance

Guide rings avoid sliding metal-to-metal contact between the piston and cylinder bore and accommodate the radial loads of forces acting on the cylinder assembly. Although piston seals are designed to accommodate slight radial motion between the piston and bore, effective guide ring function to accurately centre the piston within the bore is important for piston seal performance. For additional information about piston guidance, refer to *Guide rings and guide strips* (→ **page 249**).

Piston drift

When the piston rod is at rest and held in position by fluid, any amount of flow passing the piston can result in an unintended movement of the piston rod and cause drift. Although piston seal leakage is a possible source of drift, internal valve leakage, external system leakage and flow between the piston and rod static connections should also be carefully checked. In some applications, a minimal amount of flow passing the piston seal within specified limits is permitted. This accepted flow allows the use of piston seals of low friction designs and materials or split slide rings for easy installation.

Sealing between piston and rod

The piston can be welded to the rod (→ **fig. 2**) if the disassembly of the cylinder can be done by removing the rod end attachment. The piston can also be fixed to the rod end by a lock nut (→ **fig. 3**), which enables removing the piston from the rod during complete disassembly of the cylinder. When using a lock nut, static sealing (→ *O-rings and back-up rings*, **page 291**) is required between the piston and the rod end.

Fig. 2

Piston welded to the rod end tap

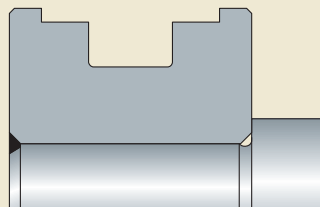
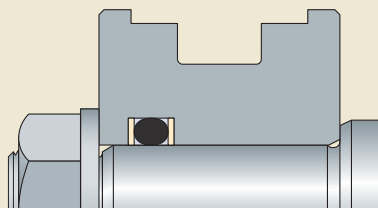

Fig. 3

Piston fixed to the rod by a lock nut and with a static seal and two back-up rings between piston and rod end



Double-acting piston seals

Double-acting cylinders are the most widely used cylinder types. They operate with pressure on both sides and, therefore, require double-acting seal arrangements (→ **fig. 1, page 48**).

Double-acting piston seals have a symmetrical profile (cross section) and identical sealing functions in both directions. Typically, double-acting piston seals consist of a slide ring and an energizer. The deformation of the elastomeric energizer when installed provides adequate force to keep the slide ring in dynamic sealing contact with the cylinder bore, while sealing statically against the seal housing groove.

A double-acting cylinder typically has the same fluid on both sides of the piston. Therefore, a relatively thick lubrication film can be permitted between the piston seal and the cylinder bore to minimize friction and wear. The transportation of fluid occurring during dynamic operation is, however, small and insignificant in most applications.

In some older cylinder designs, O-rings were used as piston seals. To allow easy replacement of O-rings with the equivalent piston seals, the housing dimensions for some double-acting piston seals are the same as those for dash-number O-rings. Therefore, these housings are also called O-ring dash-number housings.

SKF supplies double-acting piston seals in many different profiles and in a wide range of series and sizes, which make them appropriate for a wide variety of operating conditions and applications.

Piston seals with polyurethane slide rings

Piston seals with thermoplastic polyurethane (TPU) slide rings have a nitrile rubber (NBR) energizer. The wear-resistant slide ring has a profiled dynamic sealing surface. Its geometry is optimized to reduce friction and resist gap extrusion. Notches in the slide ring edges ensure rapid pressurization of the seal to react to abrupt changes in pressure. These profiles can usually be installed without special equipment and are resistant to damage during installation and cylinder assembly.

MPV profiles

MPV profiles (→ **fig. 4**) have slide rings made of X-ECOPUR PS (TPU) developed for pressures up to 400 bar (5 800 psi). They are suitable for high fluid temperatures and in medium to heavy duty applications, such as earthmoving equipment. MPV profiles are available in metric sizes and some fit seal housings in accordance with ISO 7425-1.

Fig. 4

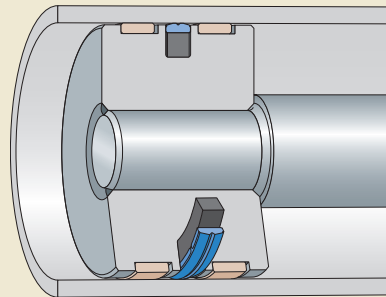

MPV

Fig. 5

DPV profiles

DPV profiles (→ **fig. 5**) have slide rings made of X-ECOPUR PS (TPU) developed for pressures up to 400 bar (5 800 *psi*). They are suitable for high fluid temperatures and for medium to heavy duty applications such as earthmoving equipment. DPV profiles are available in inch sizes where O-ring dash-number housings are used.

LPV profiles

LPV profiles (→ **fig. 6**) have a polyether-based polyurethane (EU) slide ring that provides resistance to hydrolysis (attack from moisture) and good low temperature flexibility. The O-ring energizer provides a cost-effective sealing solution. These profiles are developed for pressures up to 250 bar (3 625 *psi*) and suitable for light to medium duty applications, such as agriculture and material handling applications. They are available in metric sizes and some fit seal housings in accordance with ISO 7425-1.

CPV profiles

CPV profiles (→ **fig. 7**) have a polyester-based polyurethane (AU) slide ring. These profiles are developed for pressures up to 345 bar (5 000 *psi*) and suitable for light to medium duty applications. They are available in inch sizes where O-ring dash-number housings are used.

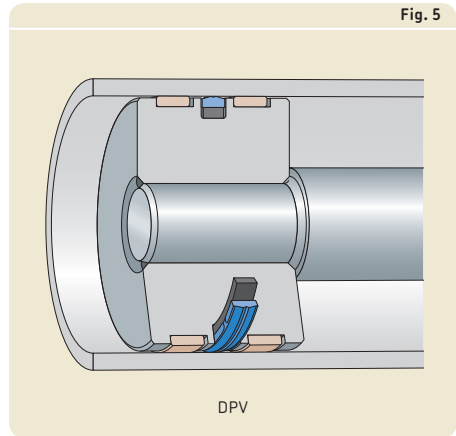

Fig. 6

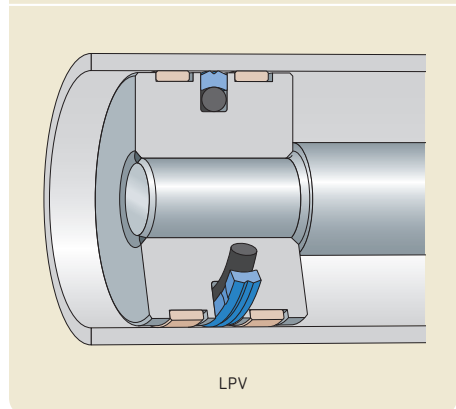
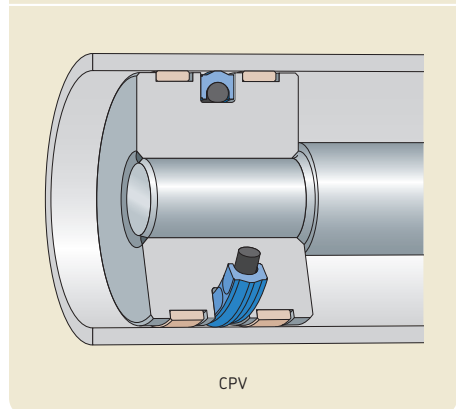

Fig. 7



Piston seals

Piston seals with PTFE slide rings

PTFE slide rings may be preferred in applications with demands for low breakaway friction and when it comes to chemical and thermal resistance. Notches in the slide ring edges ensure rapid pressurization of the seal to react to abrupt changes in pressure. PTFE is hard and non-elastic when compared with polyurethane and rubber materials. For additional information about piston seal materials, refer to *Materials* (→ page 48).

GH profiles

GH profiles (→ fig. 8) have a nitrile rubber (NBR) energizer, which is an O-ring as standard. Rectangular energizers are available on request. These profiles are suitable for pressures up to 400 bar (5 800 psi) in medium to heavy duty applications. GH profiles are available in metric and inch sizes and some metric sizes fit seal housings in accordance with ISO 7425-1.

APR profiles

APR profiles (→ fig. 9) have a nitrile rubber (NBR) O-ring energizer. The PTFE slide ring incorporates an NBR X-ring to improve sealing performance. They are suitable for pressures up to 350 bar (5 075 psi) in medium to heavy duty applications. APR profiles are available in metric and inch sizes and some metric sizes fit seal housings in accordance with ISO 7425-1.

Fig. 8

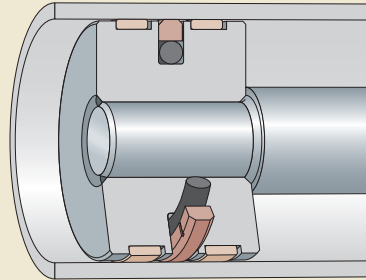

GH

Fig. 9

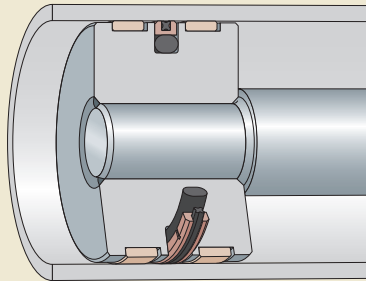

APR

Fig. 10

Piston seals incorporating anti-extrusion rings

These SKF piston seals incorporate patented locking anti-extrusion rings made of polyamide (PA). They are split for easy installation. Their snap-in design makes it easy to identify the correct installation direction (→ **fig. 10**), holds them in place when installed and prevents damage during assembly.

Piston seals incorporating anti-extrusion rings have an improved high pressure performance and minimize the risk of gap extrusion at abrupt pressure peaks (→ *Gap extrusion*, **page 48**).

LCP profiles

LCP (→ **fig. 11**) profiles have a PTFE slide ring supported by harder PA anti-extrusion rings (→ **fig. 10**) and a T-shaped nitrile rubber (NBR) energizer. These capped T-seals are suitable for pressures up to 690 bar (10 000 psi) and available in metric and inch sizes. Some metric sizes fit seal housings in accordance with ISO 5597.

LTP profiles

LTP profiles (→ **fig. 12**) have a nitrile rubber (NBR) sealing ring supported by harder PA anti-extrusion rings on both sides. These T-seals are suitable for pressures up to 345 bar (5 000 psi) in medium to heavy duty applications and are available in inch sizes where O-ring dash-number housings are used.

Patented locking anti-extrusion rings

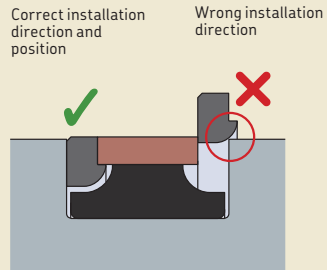
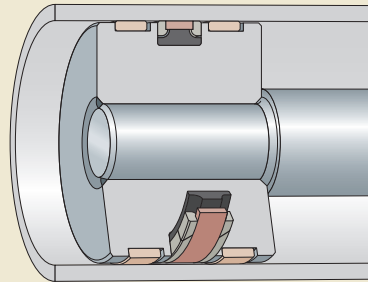
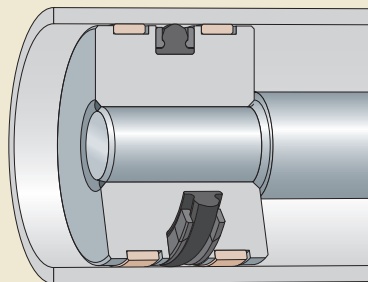

Fig. 11



LCP

Fig. 12



LTP

Piston seals

Piston seals with rigid split slide rings

These SKF piston seals have a rigid split slide ring made of glass fibre reinforced polyamide and a nitrile rubber (NBR) energizer. The rigid slide ring has high resistance to wear and gap extrusion. The slide ring also provides low friction, even at high pressures. The split slide ring design facilitates the installation process into a closed housing.

CUT profiles

CUT profiles (→ **fig. 13**) have a step cut slide ring and a rectangular energizer. They are suitable for pressures up to 500 bar (7 250 psi) in heavy duty applications. CUT profiles are available in metric sizes and some fit seal housings in accordance with ISO 7425-1.

They can be used for short pressure pulses and shock loads with proper system design. For additional information, contact SKF.

SCP profiles

SCP profiles (→ **fig. 14**) have a step cut slide ring and an oval energizer. They are suitable for pressures up to 690 bar (10 000 psi) in heavy duty applications and are available in inch sizes.

Fig. 13

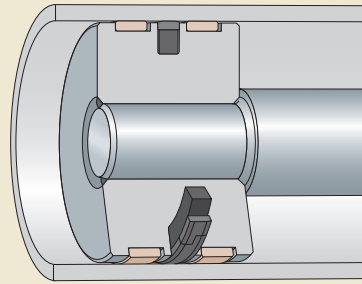

CUT

Fig. 14

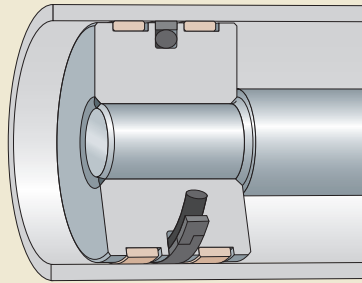

SCP

Fig. 15

Piston seals with integrated guide rings

These seals are designed as compact sets that incorporate the piston seal and guide rings into one assembly. Typically, they are applied as an all-in-one piston seal solution.

MD-L profiles

MD-L profiles (→ **fig. 15**) have a nitrile rubber (NBR) sealing ring with thermoplastic polyester elastomer (TPC) anti-extrusion rings on both sides, which incorporate the polyacetal (POM) guide rings. The guide and anti-extrusion rings are split for easy installation. MD-L profiles are suitable for pressures up to 250 bar (3 625 *psi*) in medium duty applications and are available in metric sizes. Some sizes fit seal housings in accordance with ISO 6547.

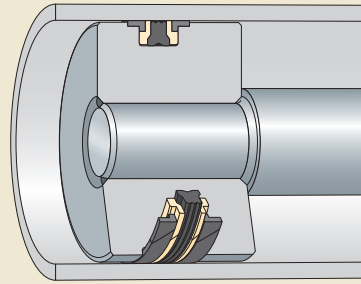

MD-L

Single-acting piston seals

A single-acting piston seal is designed for cylinders where pressure is applied from one side only. The piston in single-acting cylinders may have oil on the pressure side only, while the opposite side is open to atmosphere. Therefore, the piston seal must leave a minimum of oil film when passing along the cylinder bore since the transportation of oil otherwise would result in a leakage to the exterior.

In single-acting cylinders, the open end may push air out and draw air in as the piston reciprocates. This air may carry moisture and contaminants into the cylinder, which can lead to seal damage. Vent filters may be fitted to the open side of the cylinder to reduce contaminants entering the inside of the cylinder. The cylinder bore may be hard chromium plated to prevent corrosion.

In addition, to prevent damage to the cylinder bore or piston seals, SKF can supply special piston wiper seals on request. For additional information, contact SKF.

UNP profiles

UNP profiles (→ **fig. 16**) are single-acting U-cup seals made of thermoplastic polyurethane (TPU). They are suitable for pressures up to 350 bar (5 075 psi) and are available in metric and inch sizes. In case of higher pressures, SKF provides full-face anti-extrusion rings on request. For additional information, contact SKF.

Fig. 16

UNP profile piston seal with a wiper seal

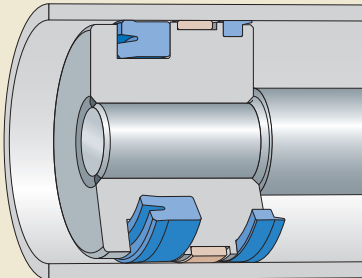

Single-acting piston seals in double-acting cylinders

Two single-acting U-cup profile seals, facing in opposite directions, can be used in a double-acting cylinder. It is important to select seal designs which can relieve reverse pressure for such arrangements to prevent build-up of pressure between the two seals. UNP profiles are suitable for such double-acting arrangements because the dynamic seal lip can flex to relieve reverse pressure.

Rod seals used as single-acting piston seals

Some rod seal profiles are designed with similar inside and outside sealing geometry and, therefore, can also be used as single-acting piston seals in single- or double-acting cylinders (→ **fig. 17**). PTB, STD and DZ rod seal profiles (→ *Rod and buffer seals*, **page 111**) can be used for those applications.

Rod seals with loaded-lip U-cup profiles may not relieve reverse pressure, but it is possible to remove their energizer (X-ring) from one of the seals to allow reverse pressure relief (→ **fig. 17**).

Fig. 17

STD profiles used as piston seals (in a double-acting arrangement)

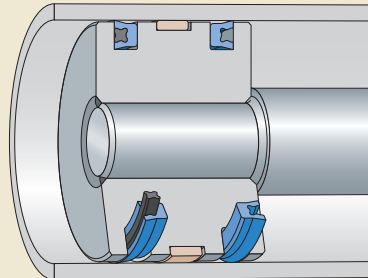

MPV profile data



Material codes	Slide ring: X-ECOPUR PS Energizer: N80/198 For additional information → page 26
Pressure	Up to 400 bar (5 800 psi)
Speed	Up to 1 m/s (3.2 ft/s)
Temperature range	<div style="display: flex; align-items: center;"> <div style="margin-right: 10px;"> <p>-60 -50 -40</p> <p>-75 -60 -40</p> </div> <div style="margin-left: 10px;"> <p>110 120 130 [°C]</p> <p>230 250 265 [°F]</p> </div> </div> <p>For temperature limits depending on fluid compatibility → table 8, page 32</p> <ul style="list-style-type: none"> ■ Extreme low temperature range: may be intermittently exposed (e.g. cold start-up) without seal damage, but seal performance may be compromised while in this range ■ Temperatures below the recommended operating range: seal performance depends on system design (precision guiding arrangement recommended) ■ Recommended operating temperature range for this profile and material ■ Temperatures above the recommended operating range: acceptable only with reduced pressure, speed, and/or e-gap ■ Extreme high temperature range: only occasional short-term exposure (e.g. cylinder in curing oven of a powder coating process)
Dimension standards	Some sizes fit seal housings in accordance with ISO 7425-1.
Counter-surface	→ page 22

Maximum values of application parameters (e.g. pressure, speed, temperature, e-gap) should not be applied continuously nor simultaneously.

2.1 MPV profile piston seals, metric sizes

D 50 – 200 mm

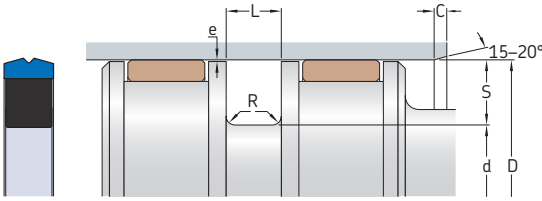

Maximum extrusion gap e

Radial depth
S

e_{max} at 80 °C (175 °F)
for pressures

	160 bar	250 bar	400 bar
--	---------	---------	---------

mm	mm		
3,75	0,4	0,4	–
5,5	0,5	0,4	0,3
7,75	0,6	0,45	0,3
10,5	0,7	0,55	0,4

For additional information → page 34

2.1

Dimensions						Designation
D H9	d h9	L +0,2	S	R max.	C min.	
mm						–
50	34,5	6,3	7,75	1,3	5	• MPV-50x34.5x6.3
55	39,5	6,3	7,75	1,3	5	MPV-55x39.5x6.3
60	44,5	6,3	7,75	1,3	5	MPV-60x44.5x6.3
63	47,5	6,3	7,75	1,3	5	• MPV-63x47.5x6.3
65	49,5	6,3	7,75	1,3	5	MPV-65x49.5x6.3
70	54,5	6,3	7,75	1,3	5	MPV-70x54.5x6.3
	59	4,2	5,5	1,3	5	MPV-70x59x4.2
75	59,5	6,3	7,75	1,3	5	MPV-75x59.5x6.3
80	59	8,1	10,5	1,8	6	MPV-80x59x8.1
	64,5	6,3	7,75	1,8	6	• MPV-80x64.5x6.3
85	64	8,1	10,5	1,8	6	MPV-85x64x8.1
90	69	8,1	10,5	1,8	6	MPV-90x69x8.1
100	79	8,1	10,5	1,8	6	MPV-100x79x8.1
110	89	8,1	10,5	1,8	6	MPV-110x89x8.1
120	99	8,1	10,5	1,8	6	MPV-120x99x8.1
125	104	8,1	10,5	1,8	6	MPV-125x104x8.1
130	109	8,1	10,5	1,8	6	MPV-130x109x8.1
150	129	8,1	10,5	1,8	6	MPV-150x129x8.1
160	139	8,1	10,5	1,8	6	• MPV-160x139x8.1
180	159	8,1	10,5	1,8	6	MPV-180x159x8.1
200	179	8,1	10,5	1,8	6	• MPV-200x179x8.1

Other sizes are available on request

• Seal housing dimensions in accordance with ISO 7425-1

2.2 DPV profile piston seals, inch sizes

D 1 – 6.002 in.

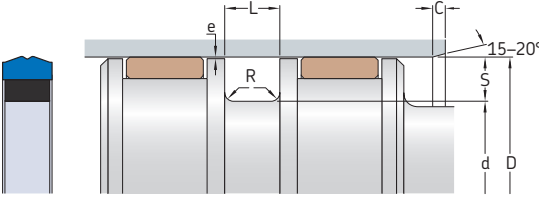

Maximum extrusion gap e

Radial Series e_{\max} at 80 °C (175 °F)
depth for pressures
S 2 300 psi 3 600 psi 5 800 psi

in. – in.

0.125	2	0.012	0.008	–
0.187	3	0.018	0.012	0.008
0.25	4	0.022	0.016	0.01

For additional information → page 34

Dimensions							Designation
D +0.002	d	Tolerance	L +0.005	S	R max.	C min.	
in.							–
1	0.758	–0.002	0.187	0.125	0.02	0.125	DPV-210-K0M
1.5	1.258	–0.002	0.187	0.125	0.02	0.125	DPV-218-K0M
1.75	1.508	–0.002	0.187	0.125	0.02	0.125	DPV-222-K0M
2	1.63	–0.002	0.281	0.187	0.025	0.156	DPV-326-K0M
2.25	1.88	–0.002	0.281	0.187	0.025	0.156	DPV-328-K0M
2.5	2.13	–0.002	0.281	0.187	0.025	0.156	DPV-330-K0M
2.75	2.38	–0.002	0.281	0.187	0.025	0.156	DPV-332-K0M
3	2.63	–0.002	0.281	0.187	0.025	0.156	DPV-334-K0M
3.5	3.13	–0.002	0.281	0.187	0.025	0.156	DPV-338-K0M
3.75	3.38	–0.002	0.281	0.187	0.025	0.156	DPV-340-K0M
4	3.63	–0.002	0.281	0.187	0.025	0.156	DPV-342-K0M
4.5	4.13	–0.002	0.281	0.187	0.025	0.156	DPV-346-K0M
5	4.63	–0.002	0.281	0.187	0.025	0.156	DPV-350-K0M
5.502	5.028	–0.004	0.375	0.25	0.032	0.187	DPV-429-K0M
6.002	5.528	–0.004	0.375	0.25	0.032	0.187	DPV-433-K0M

Other sizes are available on request

LPV profile data



Material codes	Slide ring: PU54/199 Energizer: N70/6052 For additional information → page 26
Pressure	Up to 250 bar (3 625 psi)
Speed	Up to 0,5 m/s (1.6 ft/s)
Temperature range	<div style="display: flex; align-items: center;"> </div> <p>For temperature limits depending on fluid compatibility → table 8, page 32</p> <ul style="list-style-type: none"> ■ Extreme low temperature range: may be intermittently exposed (e.g. cold start-up) without seal damage, but seal performance may be compromised while in this range ■ Temperatures below the recommended operating range: seal performance depends on system design (precision guiding arrangement recommended) ■ Recommended operating temperature range for this profile and material ■ Temperatures above the recommended operating range: acceptable only with reduced pressure, speed, and/or e-gap ■ Extreme high temperature range: only occasional short-term exposure (e.g. cylinder in curing oven of a powder coating process)
Dimension standards	Some sizes fit seal housings in accordance with ISO 7425-1.
Counter-surface	→ page 22

Maximum values of application parameters (e.g. pressure, speed, temperature, e-gap) should not be applied continuously nor simultaneously.

2.3 LPV profile piston seals, metric sizes

D 25 – 100 mm

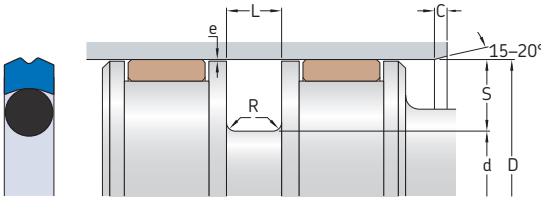

Maximum extrusion gap e

Radial depth e_{\max} at 80 °C (175 °F) for pressures

S	e_{\max} at 80 °C (175 °F) for pressures	
	160 bar	250 bar
mm	mm	
3,75	0,3	0,2
5,5	0,4	0,25
7,75	0,4	0,3
10,5	0,5	0,4

For additional information → page 34

2.3

Dimensions						Designation
D	d	L	S	R	C	
H9	h9	+0,2		max.	min.	
mm						-
25	17,5	3,2	3,75	0,5	2	• LPV 25x17.5x3.2
30	22,5	3,2	3,75	0,5	2	LPV 30x22.5x3.2
32	24,5	3,2	3,75	0,5	2	• LPV 32x24.5x3.2
35	24	4,2	5,5	0,5	2,5	LPV 35x24x4.2
40	29	4,2	5,5	0,5	2,5	• LPV 40x29x4.2
50	39	4,2	5,5	0,5	2,5	• LPV 50x39x4.2
55	44	4,2	5,5	0,5	2,5	LPV 55x44x4.2
60	49	4,2	5,5	0,5	2,5	LPV 60x49x4.2
63	52	4,2	5,5	0,5	2,5	• LPV 63x52x4.2
65	54	4,2	5,5	0,9	2,5	LPV 65x54x4.2
70	59	4,2	5,5	0,9	2,5	LPV 70x59x4.2
80	64,5	6,3	7,75	0,9	4	• LPV 80x64.5x6.3
90	74,5	6,3	7,75	0,9	4	LPV 90x74.5x6.3
100	84,5	6,3	7,75	0,9	4	• LPV 100x84.5x6.3

Other sizes are available on request

• Dimensions in accordance with ISO 7425-1

CPV profile data



Material codes	Slide ring: U-1003 Energizer: A-8501 For additional information → page 26
Pressure	Up to 345 bar (5 000 psi)
Speed	Pressure ≤ 250 bar (3 625 psi) → up to 1 m/s (3.2 ft/s) Pressure > 250 bar (3 625 psi) → up to 0,5 m/s (1.6 ft/s)
Temperature range	<p>For temperature limits depending on fluid compatibility → table 8, page 32</p> <ul style="list-style-type: none"> ■ Extreme low temperature range: may be intermittently exposed (e.g. cold start-up) without seal damage, but seal performance may be compromised while in this range ■ Temperatures below the recommended operating range: seal performance depends on system design (precision guiding arrangement recommended) ■ Recommended operating temperature range for this profile and material ■ Temperatures above the recommended operating range: acceptable only with reduced pressure, speed, and/or e-gap ■ Extreme high temperature range: only occasional short-term exposure (e.g. cylinder in curing oven of a powder coating process)
Counter-surface	→ page 22

Maximum values of application parameters (e.g. pressure, speed, temperature, e-gap) should not be applied continuously nor simultaneously.

2.4 CPV profile piston seals, inch sizes

D 1.5 – 9.002 in.

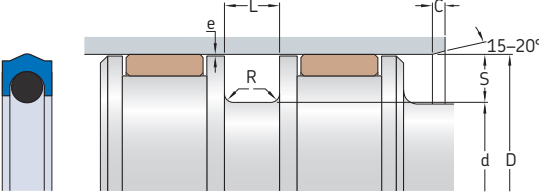

Maximum extrusion gap e

Radial Series e_{\max} at 80 °C (175 °F)
depth for pressures
S 2 300 psi 3 600 psi 5 000 psi

in.		in.		
0.121	2	0.008	0.006	–
0.185	3	0.012	0.008	0.004
0.237	4	0.014	0.01	0.006

For additional information → page 34

2.4

Dimensions							Designation
D +0.002	d	Tolerance	L +0.005	S	R max.	C min.	
in.							–
1.5	1.258	–0.002	0.187	0.121	0.02	0.125	CPV-218-J1S
1.75	1.508	–0.002	0.187	0.121	0.02	0.125	CPV-222-J1S
2	1.63	–0.002	0.281	0.185	0.025	0.156	CPV-326-J1S
2.25	1.88	–0.002	0.281	0.185	0.025	0.156	CPV-328-J1S
2.5	2.13	–0.002	0.281	0.185	0.025	0.156	CPV-330-J1S
2.75	2.38	–0.002	0.281	0.185	0.025	0.156	CPV-332-J1S
3	2.63	–0.002	0.281	0.185	0.025	0.156	CPV-334-J1S
3.125	2.755	–0.002	0.281	0.185	0.025	0.156	CPV-335-J1S
3.25	2.88	–0.002	0.281	0.185	0.025	0.156	CPV-336-J1S
3.5	3.13	–0.002	0.281	0.185	0.025	0.156	CPV-338-J1S
4	3.63	–0.002	0.281	0.185	0.025	0.156	CPV-342-J1S
4.5	4.13	–0.002	0.281	0.185	0.025	0.156	CPV-346-J1S
5	4.63	–0.002	0.281	0.185	0.025	0.156	CPV-350-J1S
5.502	5.028	–0.004	0.375	0.237	0.032	0.187	CPV-429-J1S
6.002	5.528	–0.004	0.375	0.237	0.032	0.187	CPV-433-J1S
6.502	6.028	–0.004	0.375	0.237	0.032	0.187	CPV-437-J1S
7.002	6.528	–0.004	0.375	0.237	0.032	0.187	CPV-439-J1S
7.252	6.778	–0.004	0.375	0.237	0.032	0.187	CPV-440-J1S
8.002	7.528	–0.004	0.375	0.237	0.032	0.187	CPV-443-J1S
9.002	8.528	–0.004	0.375	0.237	0.032	0.187	CPV-446-J1S

Other sizes are available on request

GH profile data



Material codes	Slide ring: metric sizes → 292 inch sizes → 741 Energizer: metric sizes → N70/6052 inch sizes → A-8501 For additional information → page 26
Pressure	Up to 400 bar (5 800 psi)
Speed	Up to 1 m/s (3.2 ft/s)
Temperature range	<p>For temperature limits depending on fluid compatibility → table 8, page 32</p> <ul style="list-style-type: none"> ■ Extreme low temperature range: may be intermittently exposed (e.g. cold start-up) without seal damage, but seal performance may be compromised while in this range ■ Temperatures below the recommended operating range: seal performance depends on system design (precision guiding arrangement recommended) ■ Recommended operating temperature range for this profile and material ■ Temperatures above the recommended operating range: acceptable only with reduced pressure, speed, and/or e-gap ■ Extreme high temperature range: only occasional short-term exposure (e.g. cylinder in curing oven of a powder coating process)
Dimension standards	Some metric sizes fit seal housings in accordance with ISO 7425-1.
Counter-surface	→ page 22

Maximum values of application parameters (e.g. pressure, speed, temperature, e-gap) should not be applied continuously nor simultaneously.

2.5 GH profile piston seals, metric sizes

D 14 – 70 mm

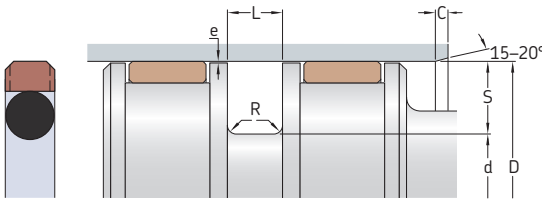

Maximum extrusion gap e

Radial depth S	e _{max} at 80 °C (175 °F) for pressures		
	160 bar	250 bar	400 bar
mm	mm		
2,45	0,35	0,25	0,15
3,75	0,35	0,25	0,15
5,5	0,4	0,3	0,2
7,75	0,5	0,35	0,25
10,5	0,6	0,45	0,35

For additional information → page 34

2.5

Dimensions						Designation
D	d	L	S	R	C	
H9	h9	+0,2		max.	min.	
mm	mm					-
14	9,1	2,2	2,45	0,5	3	GH 14x9.1x2.2-AD1
18	10,5	3,2	3,75	0,5	5	GH 18x10.5x3.2-AD1
20	12,5	3,2	3,75	0,5	5	• GH 20x12.5x3.2-AD1
	15,1	2,2	2,45	0,5	3	GH 20x15.1x2.2-AD1
22	14,5	3,2	3,75	0,5	5	GH 22x14.5x3.2-AD1
25	17,5	3,2	3,75	0,5	5	• GH 25x17.5x3.2-AD1
28	20,5	3,2	3,75	0,5	5	GH 28x20.5x3.2-AD1
30	22,5	3,2	3,75	0,5	5	GH 30x22.5x3.2-AD1
32	24,5	3,2	3,75	0,5	5	• GH 32x24.5x3.2-AD1
35	27,5	3,2	3,75	0,5	5	GH 35x27.5x3.2-AD1
36	28,5	3,2	3,75	0,5	5	GH 36x28.5x3.2-AD1
40	29	4,2	5,5	0,5	7	• GH 40x29x4.2-AD1
	32,5	3,2	3,75	0,5	5	• GH 40x32.5x3.2-AD1
45	34	4,2	5,5	0,5	7	GH 45x34x4.2-AD1
	37,5	3,2	3,75	0,5	5	GH 45x37.5x3.2-AD1
50	34,5	6,3	7,75	0,5	10	• GH 50x34.5x6.3-AD1
	39	4,2	5,5	0,5	7	• GH 50x39x4.2-AD1
60	49	4,2	5,5	0,5	7	GH 60x49x4.2-AD1
63	52	4,2	5,5	0,5	7	• GH 63x52x4.2-AD1
65	54	4,2	5,5	0,9	7	GH 65x54x4.2-AD1
70	59	4,2	5,5	0,9	7	GH 70x59x4.2-AD1

• Seal housing dimensions in accordance with ISO 7425-1

2.5 GH profile piston seals, metric sizes

D 75 – 200 mm

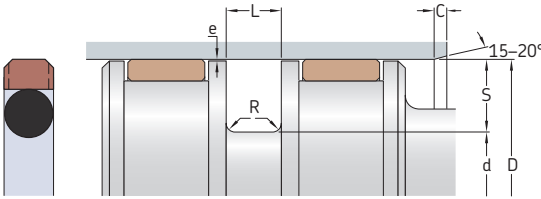

Maximum extrusion gap e

Radial depth S	e _{max} at 80 °C (175 °F) for pressures		
	160 bar	250 bar	400 bar
mm	mm		
2,45	0,35	0,25	0,15
3,75	0,35	0,25	0,15
5,5	0,4	0,3	0,2
7,75	0,5	0,35	0,25
10,5	0,6	0,45	0,35

For additional information → page 34

Dimensions

D	d	L	S	R	C
H9	h9	+0,2		max.	min.

mm

Designation

75	59,5 64	6,3 4,2	7,75 5,5	0,9 0,9	10 7	GH 75x59.5x6.3-AD1 GH 75x64x4.2-AD1
80	64,5 69	6,3 4,2	7,75 5,5	0,9 0,9	10 7	• GH 80x64.5x6.3-AD1 • GH 80x69x4.2-AD1
85	69,5 74	6,3 4,2	7,75 5,5	0,9 0,9	10 7	GH 85x69.5x6.3-AD1 GH 85x74x4.2-AD1
90	74,5 79	6,3 4,2	7,75 5,5	0,9 0,9	10 7	GH 90x74.5x6.3-AD1 GH 90x79x4.2-AD1
95	79,5 84	6,3 4,2	7,75 5,5	0,9 0,9	10 7	GH 95x79.5x6.3-AD1 GH 95x84x4.2-AD1
100	79 84,5	8,1 6,3	10,5 7,75	0,9 0,9	12 10	GH 100x79x8.1-AD1 • GH 100x84.5x6.3-AD1
105	89,5	6,3	7,75	0,9	10	GH 105x89.5x6.3-AD1
110	94,5	6,3	7,75	0,9	10	GH 110x94.5x6.3-AD1
115	99,5	6,3	7,75	0,9	10	GH 115x99.5x6.3-AD1
120	104,5	6,3	7,75	0,9	10	GH 120x104.5x6.3-AD1
125	104 109,5	8,1 6,3	10,5 7,75	0,9 0,9	12 10	• GH 125x104x8.1-AD1 • GH 125x109.5x6.3-AD1
130	109 114,5	8,1 6,3	10,5 7,75	0,9 0,9	12 10	GH 130x109x8.1-AD1 GH 130x114.5x6.3-AD1
140	119 124,5	8,1 6,3	10,5 7,75	0,9 0,9	12 10	GH 140x119x8.1-AD1 GH 140x124.5x6.3-AD1
150	129 134,5	8,1 6,3	10,5 7,75	0,9 0,9	12 10	GH 150x129x8.1-AD1 GH 150x134.5x6.3-AD1

• Seal housing dimensions in accordance with ISO 7425-1

Dimensions						Designation
D H9	d h9	L +0,2	S	R max.	C min.	
mm						-
160	139	8,1	10,5	0,9	12	• GH 160x139x8.1-AD1
	144,5	6,3	7,75	0,9	10	• GH 160x144.5x6.3-AD1
170	149	8,1	10,5	0,9	12	GH 170x149x8.1-AD1
180	159	8,1	10,5	0,9	12	GH 180x159x8.1-AD1
190	169	8,1	10,5	0,9	12	GH 190x169x8.1-AD1
200	179	8,1	10,5	0,9	12	• GH 200x179x8.1-AD1

Other sizes are available on request

• Seal housing dimensions in accordance with ISO 7425-1

2.5 GH profile piston seals, inch sizes

D 0.5 – 2.375 in.

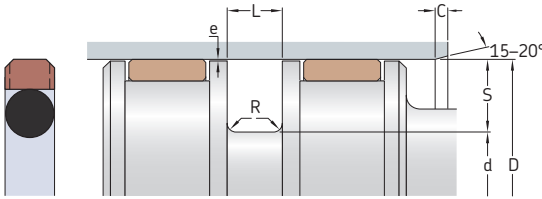

Maximum extrusion gap e

Radial Series e_{max} at 80 °C (175 °F)
depth for pressures
S 2 300 psi 3 600 psi 5 800 psi

in.		in.		
0.087	0A	0.014	0.01	0.006
0.13	0D	0.014	0.01	0.006
0.149	1A	0.014	0.01	0.006
0.196	1D	0.015	0.011	0.007
0.212	2A	0.016	0.012	0.008
0.259	2D	0.018	0.013	0.009
0.308	3A	0.02	0.014	0.01
0.415	4A	0.024	0.018	0.014

For additional information → page 34

Dimensions

Designation

D	Tolerance	d	Tolerance	L	S	R	C	
				±0.002		max.	min.	
in.								-
0.5	+0.002	0.24	±0.002	0.083	0.13	0.015	0.1	GH0D-500-AD1
	+0.002	0.326	±0.001	0.083	0.087	0.015	0.08	GH0A-500-AD1
0.562	+0.002	0.302	±0.002	0.083	0.13	0.015	0.1	GH0D-562-AD1
	+0.002	0.388	±0.001	0.083	0.087	0.015	0.08	GH0A-562-AD1
0.625	+0.002	0.365	±0.002	0.083	0.13	0.015	0.1	GH0D-625-AD1
	+0.002	0.451	±0.001	0.083	0.087	0.015	0.08	GH0A-625-AD1
0.687	+0.002	0.389	±0.001	0.128	0.149	0.015	0.125	GH1A-687-AD1
	+0.002	0.427	±0.002	0.083	0.13	0.015	0.1	GH0D-687-AD1
	+0.002	0.513	±0.001	0.083	0.087	0.015	0.08	GH0A-687-AD1
0.75	+0.002	0.452	±0.001	0.128	0.149	0.015	0.125	GH1A-750-AD1
	+0.002	0.49	±0.002	0.083	0.13	0.015	0.1	GH0D-750-AD1
	+0.002	0.576	±0.001	0.083	0.087	0.015	0.08	GH0A-750-AD1
0.812	+0.002	0.514	±0.001	0.128	0.149	0.015	0.125	GH1A-812-AD1
	+0.002	0.552	±0.002	0.083	0.13	0.015	0.1	GH0D-812-AD1
	+0.002	0.638	±0.001	0.083	0.087	0.015	0.08	GH0A-812-AD1
0.875	+0.002	0.577	±0.001	0.128	0.149	0.015	0.125	GH1A-875-AD1
	+0.002	0.615	±0.002	0.083	0.13	0.015	0.1	GH0D-875-AD1
	+0.002	0.701	±0.001	0.083	0.087	0.015	0.08	GH0A-875-AD1
0.937	+0.002	0.639	±0.001	0.128	0.149	0.015	0.125	GH1A-937-AD1
	+0.002	0.677	±0.002	0.083	0.13	0.015	0.1	GH0D-937-AD1
	+0.002	0.763	±0.001	0.083	0.087	0.015	0.08	GH0A-937-AD1
1	+0.002	0.702	±0.001	0.128	0.149	0.015	0.125	GH1A-1000-AD1
	+0.002	0.74	±0.002	0.083	0.13	0.015	0.1	GH0D-1000-AD1
	+0.002	0.826	±0.001	0.083	0.087	0.015	0.08	GH0A-1000-AD1
1.062	+0.002	0.764	±0.001	0.128	0.149	0.015	0.125	GH1A-1062-AD1
	+0.002	0.802	±0.002	0.083	0.13	0.015	0.1	GH0D-1062-AD1
	+0.002	0.888	±0.001	0.083	0.087	0.015	0.08	GH0A-1062-AD1
1.125	+0.002	0.827	±0.001	0.128	0.149	0.015	0.125	GH1A-1125-AD1
	+0.002	0.865	±0.002	0.083	0.13	0.015	0.1	GH0D-1125-AD1
	+0.002	0.951	±0.001	0.083	0.087	0.015	0.08	GH0A-1125-AD1

Dimensions				Designation				
D	d	L	S	R	C			
Tolerance	Tolerance	±0.002		max.	min.			
in.							-	
1.187	+0.002	0.889	±0.001	0.128	0.149	0.015	0.125	GH1A-1187-AD1
	+0.002	0.927	±0.002	0.083	0.13	0.015	0.1	GH0D-1187-AD1
	+0.002	1.013	±0.001	0.083	0.087	0.015	0.08	GH0A-1187-AD1
1.25	+0.002	0.952	±0.001	0.128	0.149	0.015	0.125	GH1A-1250-AD1
	+0.002	0.99	±0.002	0.083	0.13	0.015	0.1	GH0D-1250-AD1
	+0.002	1.076	±0.001	0.083	0.087	0.015	0.08	GH0A-1250-AD1
1.312	+0.002	1.014	±0.001	0.128	0.149	0.015	0.125	GH1A-1312-AD1
	+0.002	1.052	±0.002	0.083	0.13	0.015	0.1	GH0D-1312-AD1
	+0.002	1.138	±0.001	0.083	0.087	0.015	0.08	GH0A-1312-AD1
1.375	+0.002	1.077	±0.001	0.128	0.149	0.015	0.125	GH1A-1375-AD1
	+0.002	1.115	±0.002	0.083	0.13	0.015	0.1	GH0D-1375-AD1
	+0.002	1.201	±0.001	0.083	0.087	0.015	0.08	GH0A-1375-AD1
1.437	+0.002	1.139	±0.001	0.128	0.149	0.015	0.125	GH1A-1437-AD1
	+0.002	1.177	±0.002	0.083	0.13	0.015	0.1	GH0D-1437-AD1
	+0.002	1.263	±0.001	0.083	0.087	0.015	0.08	GH0A-1437-AD1
1.5	+0.002	1.202	±0.001	0.128	0.149	0.015	0.125	GH1A-1500-AD1
	+0.002	1.24	±0.002	0.083	0.13	0.015	0.1	GH0D-1500-AD1
	+0.002	1.326	±0.001	0.083	0.087	0.015	0.08	GH0A-1500-AD1
1.562	+0.002	1.138	±0.002	0.168	0.212	0.015	0.14	GH2A-1562-AD1
	+0.002	1.17	±0.002	0.122	0.196	0.015	0.125	GH1D-1562-AD1
	+0.002	1.264	±0.001	0.128	0.149	0.015	0.125	GH1A-1562-AD1
1.625	+0.002	1.201	±0.002	0.168	0.212	0.015	0.14	GH2A-1625-AD1
	+0.002	1.233	±0.002	0.122	0.196	0.015	0.125	GH1D-1625-AD1
	+0.002	1.327	±0.001	0.128	0.149	0.015	0.125	GH1A-1625-AD1
1.687	+0.002	1.263	±0.002	0.168	0.212	0.015	0.14	GH2A-1687-AD1
	+0.002	1.295	±0.002	0.122	0.196	0.015	0.125	GH1D-1687-AD1
	+0.002	1.389	±0.001	0.128	0.149	0.015	0.125	GH1A-1687-AD1
1.75	+0.002	1.326	±0.002	0.168	0.212	0.015	0.14	GH2A-1750-AD1
	+0.002	1.358	±0.002	0.122	0.196	0.015	0.125	GH1D-1750-AD1
	+0.002	1.452	±0.001	0.128	0.149	0.015	0.125	GH1A-1750-AD1
1.812	+0.002	1.388	±0.002	0.168	0.212	0.015	0.14	GH2A-1812-AD1
	+0.002	1.42	±0.002	0.122	0.196	0.015	0.125	GH1D-1812-AD1
	+0.002	1.514	±0.001	0.128	0.149	0.015	0.125	GH1A-1812-AD1
1.875	+0.002	1.451	±0.002	0.168	0.212	0.015	0.14	GH2A-1875-AD1
	+0.002	1.483	±0.002	0.122	0.196	0.015	0.125	GH1D-1875-AD1
	+0.002	1.577	±0.001	0.128	0.149	0.015	0.125	GH1A-1875-AD1
1.937	+0.002	1.513	±0.002	0.168	0.212	0.015	0.14	GH2A-1937-AD1
	+0.002	1.545	±0.002	0.122	0.196	0.015	0.125	GH1D-1937-AD1
	+0.002	1.639	±0.001	0.128	0.149	0.015	0.125	GH1A-1937-AD1
2	+0.002	1.576	±0.002	0.168	0.212	0.015	0.14	GH2A-2000-AD1
	+0.002	1.608	±0.002	0.129	0.196	0.015	0.125	GH1D-2000-AD1
	+0.002	1.702	±0.001	0.128	0.149	0.015	0.125	GH1A-2000-AD1
2.125	+0.002	1.701	±0.002	0.168	0.212	0.015	0.14	GH2A-2125-AD1
	+0.002	1.733	±0.002	0.129	0.196	0.015	0.125	GH1D-2125-AD1
	+0.002	1.827	±0.001	0.128	0.149	0.015	0.125	GH1A-2125-AD1
2.25	+0.002	1.826	±0.002	0.168	0.212	0.015	0.14	GH2A-2250-AD1
	+0.002	1.858	±0.002	0.129	0.196	0.015	0.125	GH1D-2250-AD1
	+0.002	1.952	±0.001	0.128	0.149	0.015	0.125	GH1A-2250-AD1
2.375	+0.002	1.951	±0.002	0.168	0.212	0.015	0.14	GH2A-2375-AD1
	+0.002	1.983	±0.002	0.129	0.196	0.015	0.125	GH1D-2375-AD1
	+0.002	2.077	±0.001	0.128	0.149	0.015	0.125	GH1A-2375-AD1

2.5 GH profile piston seals, inch sizes

D 2.5 – 5.625 in.

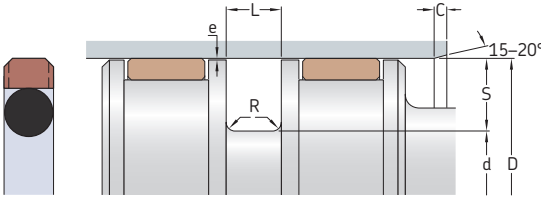

Maximum extrusion gap e

Radial Series e_{max} at 80 °C (175 °F)
depth for pressures
S 2 300 psi 3 600 psi 5 800 psi

in.		in.		
0.087	0A	0.014	0.01	0.006
0.13	0D	0.014	0.01	0.006
0.149	1A	0.014	0.01	0.006
0.196	1D	0.015	0.011	0.007
0.212	2A	0.016	0.012	0.008
0.259	2D	0.018	0.013	0.009
0.308	3A	0.02	0.014	0.01
0.415	4A	0.024	0.018	0.014

For additional information → page 34

Dimensions

Designation

D	Tolerance	d	Tolerance	L	S	R	C	
				±0.002		max.	min.	
in.								-
2.5	+0.002	2.076	±0.002	0.168	0.212	0.015	0.14	GH2A-2500-AD1
	+0.002	2.108	±0.002	0.129	0.196	0.015	0.125	GH1D-2500-AD1
	+0.002	2.202	±0.001	0.128	0.149	0.015	0.125	GH1A-2500-AD1
2.625	+0.002	2.201	±0.002	0.168	0.212	0.015	0.14	GH2A-2625-AD1
	+0.002	2.233	±0.002	0.129	0.196	0.015	0.125	GH1D-2625-AD1
	+0.002	2.327	±0.001	0.128	0.149	0.015	0.125	GH1A-2625-AD1
2.75	+0.002	2.326	±0.002	0.168	0.212	0.015	0.14	GH2A-2750-AD1
	+0.002	2.358	±0.002	0.129	0.196	0.015	0.125	GH1D-2750-AD1
	+0.002	2.452	±0.001	0.128	0.149	0.015	0.125	GH1A-2750-AD1
2.875	+0.002	2.451	±0.002	0.168	0.212	0.015	0.14	GH2A-2875-AD1
	+0.002	2.483	±0.002	0.129	0.196	0.015	0.125	GH1D-2875-AD1
	+0.002	2.577	±0.001	0.128	0.149	0.015	0.125	GH1A-2875-AD1
3	+0.002	2.576	±0.002	0.168	0.212	0.015	0.14	GH2A-3000-AD1
	+0.002	2.608	±0.002	0.129	0.196	0.015	0.125	GH1D-3000-AD1
	+0.002	2.702	±0.001	0.128	0.149	0.015	0.125	GH1A-3000-AD1
3.125	+0.002	2.509	±0.003	0.249	0.308	0.025	0.2	GH3A-3125-AD1
	+0.002	2.701	±0.002	0.168	0.212	0.015	0.14	GH2A-3125-AD1
	+0.003	2.733	±0.002	0.129	0.196	0.015	0.125	GH1D-3125-AD1
3.25	+0.002	2.634	±0.003	0.249	0.308	0.025	0.2	GH3A-3250-AD1
	+0.002	2.826	±0.002	0.168	0.212	0.015	0.14	GH2A-3250-AD1
	+0.003	2.858	±0.002	0.129	0.196	0.015	0.125	GH1D-3250-AD1
3.375	+0.002	2.759	±0.003	0.249	0.308	0.025	0.2	GH3A-3375-AD1
	+0.002	2.951	±0.002	0.168	0.212	0.015	0.14	GH2A-3375-AD1
	+0.003	2.983	±0.002	0.129	0.196	0.015	0.125	GH1D-3375-AD1
3.5	+0.002	2.884	±0.003	0.249	0.308	0.025	0.2	GH3A-3500-AD1
	+0.002	3.076	±0.002	0.168	0.212	0.015	0.14	GH2A-3500-AD1
	+0.003	3.108	±0.002	0.129	0.196	0.015	0.125	GH1D-3500-AD1
3.625	+0.002	3.009	±0.003	0.249	0.308	0.025	0.2	GH3A-3625-AD1
	+0.002	3.201	±0.002	0.168	0.212	0.015	0.14	GH2A-3625-AD1
	+0.003	3.233	±0.002	0.129	0.196	0.015	0.125	GH1D-3625-AD1

Dimensions				Designation				
D	Tolerance	d	Tolerance	L ±0.002	S	R max.	C min.	
in.								
3.75	+0.002	3.134	±0.003	0.249	0.308	0.025	0.2	GH3A-3750-AD1
	+0.002	3.326	±0.002	0.168	0.212	0.015	0.14	GH2A-3750-AD1
	+0.003	3.358	±0.002	0.129	0.196	0.015	0.125	GH1D-3750-AD1
3.875	+0.002	3.259	±0.003	0.249	0.308	0.025	0.2	GH3A-3875-AD1
	+0.002	3.451	±0.002	0.168	0.212	0.015	0.14	GH2A-3875-AD1
	+0.003	3.483	±0.002	0.129	0.196	0.015	0.125	GH1D-3875-AD1
4	+0.002	3.384	±0.003	0.249	0.308	0.025	0.2	GH3A-4000-AD1
	+0.002	3.576	±0.002	0.168	0.212	0.015	0.14	GH2A-4000-AD1
	+0.003	3.608	±0.002	0.129	0.196	0.015	0.125	GH1D-4000-AD1
4.125	+0.002	3.509	±0.003	0.249	0.308	0.025	0.2	GH3A-4125-AD1
	+0.002	3.701	±0.002	0.168	0.212	0.015	0.14	GH2A-4125-AD1
	+0.003	3.733	±0.002	0.129	0.196	0.015	0.125	GH1D-4125-AD1
4.25	+0.002	3.634	±0.003	0.249	0.308	0.025	0.2	GH3A-4250-AD1
	+0.002	3.826	±0.002	0.168	0.212	0.015	0.14	GH2A-4250-AD1
	+0.003	3.858	±0.002	0.129	0.196	0.015	0.125	GH1D-4250-AD1
4.375	+0.002	3.759	±0.003	0.249	0.308	0.025	0.2	GH3A-4375-AD1
	+0.002	3.951	±0.002	0.168	0.212	0.015	0.14	GH2A-4375-AD1
	+0.003	3.983	±0.002	0.129	0.196	0.015	0.125	GH1D-4375-AD1
4.5	+0.002	3.884	±0.003	0.249	0.308	0.025	0.2	GH3A-4500-AD1
	+0.002	4.076	±0.002	0.168	0.212	0.015	0.14	GH2A-4500-AD1
	+0.003	4.108	±0.002	0.129	0.196	0.015	0.125	GH1D-4500-AD1
4.625	+0.002	4.009	±0.003	0.249	0.308	0.025	0.2	GH3A-4625-AD1
	+0.002	4.201	±0.002	0.168	0.212	0.015	0.14	GH2A-4625-AD1
	+0.003	4.233	±0.002	0.129	0.196	0.015	0.125	GH1D-4625-AD1
4.75	+0.002	4.134	±0.003	0.249	0.308	0.025	0.2	GH3A-4750-AD1
	+0.002	4.326	±0.002	0.168	0.212	0.015	0.14	GH2A-4750-AD1
	+0.003	4.358	±0.002	0.129	0.196	0.015	0.125	GH1D-4750-AD1
4.875	+0.002	4.259	±0.003	0.249	0.308	0.025	0.2	GH3A-4875-AD1
	+0.002	4.451	±0.002	0.168	0.212	0.015	0.14	GH2A-4875-AD1
	+0.003	4.483	±0.002	0.129	0.196	0.015	0.125	GH1D-4875-AD1
5	+0.002	4.384	±0.003	0.249	0.308	0.025	0.2	GH3A-5000-AD1
	+0.002	4.576	±0.002	0.168	0.212	0.015	0.14	GH2A-5000-AD1
	+0.003	4.608	±0.002	0.129	0.196	0.015	0.125	GH1D-5000-AD1
5.125	+0.002	4.509	±0.003	0.249	0.308	0.025	0.2	GH3A-5125-AD1
	+0.002	4.701	±0.002	0.168	0.212	0.015	0.14	GH2A-5125-AD1
	+0.003	4.733	±0.002	0.129	0.196	0.015	0.125	GH1D-5125-AD1
5.25	+0.002	4.42	±0.004	0.322	0.415	0.035	0.25	GH4A-5250-AD1
	+0.002	4.634	±0.003	0.249	0.308	0.025	0.2	GH3A-5250-AD1
	+0.003	4.826	±0.002	0.168	0.212	0.015	0.14	GH2A-5250-AD1
	+0.003	4.858	±0.002	0.129	0.196	0.015	0.125	GH1D-5250-AD1
5.375	+0.002	4.545	±0.004	0.322	0.415	0.035	0.25	GH4A-5375-AD1
	+0.002	4.759	±0.003	0.249	0.308	0.025	0.2	GH3A-5375-AD1
	+0.003	4.951	±0.002	0.168	0.212	0.015	0.14	GH2A-5375-AD1
	+0.004	4.983	±0.002	0.129	0.196	0.015	0.125	GH1D-5375-AD1
5.5	+0.002	4.67	±0.004	0.322	0.415	0.035	0.25	GH4A-5500-AD1
	+0.002	4.884	±0.003	0.249	0.308	0.025	0.2	GH3A-5500-AD1
	+0.003	5.076	±0.002	0.168	0.212	0.015	0.14	GH2A-5500-AD1
	+0.004	5.108	±0.002	0.129	0.196	0.015	0.125	GH1D-5500-AD1
5.625	+0.003	4.795	±0.004	0.322	0.415	0.035	0.25	GH4A-5625-AD1
	+0.003	5.009	±0.003	0.249	0.308	0.025	0.2	GH3A-5625-AD1
	+0.004	5.107	±0.004	0.159	0.259	0.015	0.14	GH2D-5625-AD1

2.5

2.5 GH profile piston seals, inch sizes

D 5.75 – 16 in.

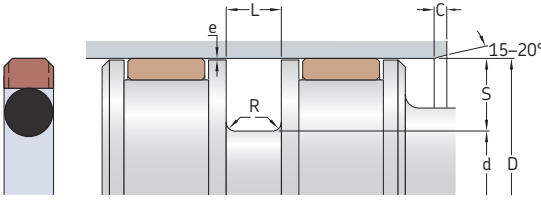

Maximum extrusion gap e

Radial Series e_{\max} at 80 °C (175 °F)
depth S for pressures
2 300 psi 3 600 psi 5 800 psi

in.	-	in.		
0.087	0A	0.014	0.01	0.006
0.13	0D	0.014	0.01	0.006
0.149	1A	0.014	0.01	0.006
0.196	1D	0.015	0.011	0.007
0.212	2A	0.016	0.012	0.008
0.259	2D	0.018	0.013	0.009
0.308	3A	0.02	0.014	0.01
0.415	4A	0.024	0.018	0.014

For additional information → page 34

Dimensions

Designation

D	Tolerance	d	Tolerance	L	S	R	C	
in.				±0.002		max.	min.	-
5.75	+0.003	4.92	±0.004	0.322	0.415	0.035	0.25	GH4A-5750-AD1
	+0.003	5.134	±0.003	0.249	0.308	0.025	0.2	GH3A-5750-AD1
	+0.004	5.232	±0.004	0.159	0.259	0.015	0.14	GH2D-5750-AD1
5.875	+0.003	5.045	±0.004	0.322	0.415	0.035	0.25	GH4A-5875-AD1
	+0.003	5.259	±0.003	0.249	0.308	0.025	0.2	GH3A-5875-AD1
	+0.004	5.357	±0.004	0.159	0.259	0.015	0.14	GH2D-5875-AD1
6	+0.003	5.17	±0.004	0.322	0.415	0.035	0.25	GH4A-6000-AD1
	+0.003	5.384	±0.003	0.249	0.308	0.025	0.2	GH3A-6000-AD1
	+0.004	5.482	±0.004	0.159	0.259	0.015	0.14	GH2D-6000-AD1
6.125	+0.003	5.295	±0.004	0.322	0.415	0.035	0.25	GH4A-6125-AD1
	+0.003	5.509	±0.003	0.249	0.308	0.025	0.2	GH3A-6125-AD1
	+0.004	5.607	±0.004	0.159	0.259	0.015	0.14	GH2D-6125-AD1
6.25	+0.003	5.42	±0.004	0.322	0.415	0.035	0.25	GH4A-6250-AD1
	+0.003	5.634	±0.003	0.249	0.308	0.025	0.2	GH3A-6250-AD1
	+0.004	5.732	±0.004	0.159	0.259	0.015	0.14	GH2D-6250-AD1
6.375	+0.003	5.545	±0.004	0.322	0.415	0.035	0.25	GH4A-6375-AD1
	+0.003	5.759	±0.003	0.249	0.308	0.025	0.2	GH3A-6375-AD1
	+0.004	5.857	±0.004	0.159	0.259	0.015	0.14	GH2D-6375-AD1
6.5	+0.003	5.67	±0.004	0.322	0.415	0.035	0.25	GH4A-6500-AD1
	+0.003	5.884	±0.003	0.249	0.308	0.025	0.2	GH3A-6500-AD1
	+0.004	5.982	±0.004	0.159	0.259	0.015	0.14	GH2D-6500-AD1
6.75	+0.003	5.92	±0.004	0.322	0.415	0.035	0.25	GH4A-6750-AD1
	+0.003	6.134	±0.003	0.249	0.308	0.025	0.2	GH3A-6750-AD1
	+0.004	6.232	±0.004	0.159	0.259	0.015	0.14	GH2D-6750-AD1
7	+0.003	6.17	±0.004	0.322	0.415	0.035	0.25	GH4A-7000-AD1
	+0.003	6.384	±0.003	0.249	0.308	0.025	0.2	GH3A-7000-AD1
	+0.004	6.482	±0.004	0.159	0.259	0.015	0.14	GH2D-7000-AD1
7.25	+0.003	6.42	±0.004	0.322	0.415	0.035	0.25	GH4A-7250-AD1
	+0.003	6.634	±0.003	0.249	0.308	0.025	0.2	GH3A-7250-AD1
	+0.004	6.732	±0.004	0.159	0.259	0.015	0.14	GH2D-7250-AD1

Dimensions				Designation				
D	Tolerance	d	Tolerance	L ±0.002	S	R max.	C min.	
in.								-
7.5	+0.003	6.67	±0.004	0.322	0.415	0.035	0.25	GH4A-7500-AD1
	+0.003	6.884	±0.003	0.249	0.308	0.025	0.2	GH3A-7500-AD1
	+0.004	6.982	±0.004	0.159	0.259	0.015	0.14	GH2D-7500-AD1
7.75	+0.003	6.92	±0.004	0.322	0.415	0.035	0.25	GH4A-7750-AD1
	+0.003	7.134	±0.003	0.249	0.308	0.025	0.2	GH3A-7750-AD1
	+0.004	7.232	±0.004	0.159	0.259	0.015	0.14	GH2D-7750-AD1
8	+0.003	7.17	±0.004	0.322	0.415	0.035	0.25	GH4A-8000-AD1
	+0.003	7.384	±0.003	0.249	0.308	0.025	0.2	GH3A-8000-AD1
	+0.004	7.482	±0.004	0.159	0.259	0.015	0.14	GH2D-8000-AD1
8.25	+0.003	7.42	±0.004	0.322	0.415	0.035	0.25	GH4A-8250-AD1
	+0.003	7.634	±0.003	0.249	0.308	0.025	0.2	GH3A-8250-AD1
	+0.004	7.732	±0.004	0.159	0.259	0.015	0.14	GH2D-8250-AD1
8.5	+0.003	7.67	±0.004	0.322	0.415	0.035	0.25	GH4A-8500-AD1
	+0.003	7.884	±0.003	0.249	0.308	0.025	0.2	GH3A-8500-AD1
	+0.004	7.982	±0.004	0.159	0.259	0.015	0.14	GH2D-8500-AD1
8.75	+0.004	7.92	±0.004	0.322	0.415	0.035	0.25	GH4A-8750-AD1
9	+0.003	8.17	±0.004	0.322	0.415	0.035	0.25	GH4A-9000-AD1
	+0.003	8.384	±0.003	0.249	0.308	0.025	0.2	GH3A-9000-AD1
	+0.004	8.482	±0.004	0.159	0.259	0.015	0.14	GH2D-9000-AD1
9.5	+0.003	8.67	±0.004	0.322	0.415	0.035	0.25	GH4A-9500-AD1
	+0.003	8.884	±0.003	0.249	0.308	0.025	0.2	GH3A-9500-AD1
	+0.004	8.982	±0.004	0.159	0.259	0.015	0.14	GH2D-9500-AD1
9.75	+0.004	8.92	±0.004	0.322	0.415	0.035	0.25	GH4A-9750-AD1
10	+0.003	9.17	±0.004	0.322	0.415	0.035	0.25	GH4A-10000-AD1
	+0.003	9.384	±0.003	0.249	0.308	0.025	0.2	GH3A-10000-AD1
	+0.004	9.482	±0.004	0.159	0.259	0.015	0.14	GH2D-10000-AD1
10.5	+0.003	9.67	±0.004	0.322	0.415	0.035	0.25	GH4A-10500-AD1
	+0.003	9.884	±0.003	0.249	0.308	0.025	0.2	GH3A-10500-AD1
	+0.004	9.982	±0.004	0.159	0.259	0.015	0.14	GH2D-10500-AD1
11	+0.003	10.17	±0.004	0.322	0.415	0.035	0.25	GH4A-11000-AD1
	+0.003	10.384	±0.003	0.249	0.308	0.025	0.2	GH3A-11000-AD1
	+0.004	10.482	±0.004	0.159	0.259	0.015	0.14	GH2D-11000-AD1
11.5	+0.003	10.67	±0.004	0.322	0.415	0.035	0.25	GH4A-11500-AD1
	+0.003	10.884	±0.003	0.249	0.308	0.025	0.2	GH3A-11500-AD1
	+0.004	10.982	±0.004	0.159	0.259	0.015	0.14	GH2D-11500-AD1
12	+0.003	11.17	±0.004	0.322	0.415	0.035	0.25	GH4A-12000-AD1
	+0.003	11.384	±0.003	0.249	0.308	0.025	0.2	GH3A-12000-AD1
	+0.004	11.482	±0.004	0.159	0.259	0.015	0.14	GH2D-12000-AD1
12.5	+0.004	11.67	±0.004	0.322	0.415	0.035	0.25	GH4A-12500-AD1
13	+0.004	12.17	±0.004	0.322	0.415	0.035	0.25	GH4A-13000-AD1
13.5	+0.004	12.67	±0.004	0.322	0.415	0.035	0.25	GH4A-13500-AD1
14	+0.004	13.17	±0.004	0.322	0.415	0.035	0.25	GH4A-14000-AD1
14.5	+0.004	13.67	±0.004	0.322	0.415	0.035	0.25	GH4A-14500-AD1
15	+0.004	14.17	±0.004	0.322	0.415	0.035	0.25	GH4A-15000-AD1
15.5	+0.004	14.67	±0.004	0.322	0.415	0.035	0.25	GH4A-15500-AD1
16	+0.003	15.17	±0.004	0.322	0.415	0.035	0.25	GH4A-16000-AD1

Other sizes are available on request

APR profile data



Material codes	Slide ring: 741 X-ring and energizer: A-8501 For additional information → page 26
Pressure	Up to 350 bar (5 075 psi)
Speed	Up to 1 m/s (3.2 ft/s)
Temperature range	<p>For temperature limits depending on fluid compatibility → table 8, page 32</p> <ul style="list-style-type: none"> ■ Extreme low temperature range: may be intermittently exposed (e.g. cold start-up) without seal damage, but seal performance may be compromised while in this range ■ Temperatures below the recommended operating range: seal performance depends on system design (precision guiding arrangement recommended) ■ Recommended operating temperature range for this profile and material ■ Temperatures above the recommended operating range: acceptable only with reduced pressure, speed, and/or e-gap ■ Extreme high temperature range: only occasional short-term exposure (e.g. cylinder in curing oven of a powder coating process)
Dimension standards	Some metric sizes fit seal housings in accordance with ISO 7425-1.
Counter-surface	→ page 22

Maximum values of application parameters (e.g. pressure, speed, temperature, e-gap) should not be applied continuously nor simultaneously.

2.6 APR profile piston seals, metric sizes D 20 – 90 mm

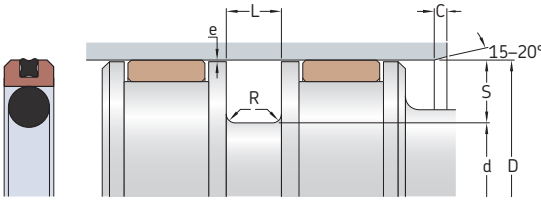

Maximum extrusion gap e

Radial depth S	e_{max} at 80 °C (175 °F) for pressures		
	70 bar	200 bar	350 bar
mm	mm		
5,5	0,46	0,15	0,1
7,75	0,6	0,2	0,13
10,5	0,76	0,25	0,15

For additional information → [page 34](#)

2.6

Dimensions						Designation
D H9	d h9	L +0,2	S	R max.	C min.	
mm						-
20	9	4,2	5,5	0,4	3	APR-20x9x4.2-AD1
22	11	4,2	5,5	0,4	3	APR-22x11x4.2-AD1
25	14	4,2	5,5	0,4	3	• APR-25x14x4.2-AD1
28	17	4,2	5,5	0,4	3	APR-28x17x4.2-AD1
30	19	4,2	5,5	0,4	3	APR-30x19x4.2-AD1
35	24	4,2	5,5	0,4	3	APR-35x24x4.2-AD1
40	29	4,2	5,5	0,4	3	• APR-40x29x4.2-AD1
42	31	4,2	5,5	0,4	3	APR-42x31x4.2-AD1
45	34	4,2	5,5	0,4	3	APR-45x34x4.2-AD1
50	39	4,2	5,5	0,4	3	• APR-50x39x4.2-AD1
55	44	4,2	5,5	0,4	3	APR-55x44x4.2-AD1
60	49	4,2	5,5	0,4	3	APR-60x49x4.2-AD1
63	52	4,2	5,5	0,4	3	• APR-63x52x4.2-AD1
65	54	4,2	5,5	0,4	3	APR-65x54x4.2-AD1
70	59	4,2	5,5	0,4	3	APR-70x59x4.2-AD1
75	64	4,2	5,5	0,4	3	APR-75x64x4.2-AD1
80	69	4,2	5,5	0,4	3	• APR-80x69x4.2-AD1
85	69,5	6,3	7,75	0,6	4	APR-85x69.5x6.3-AD1
90	74,5	6,3	7,75	0,6	4	APR-90x74.5x6.3-AD1

• Seal housing dimensions in accordance with ISO 7425-1

2.6 APR profile piston seals, metric sizes

D 95 – 190 mm

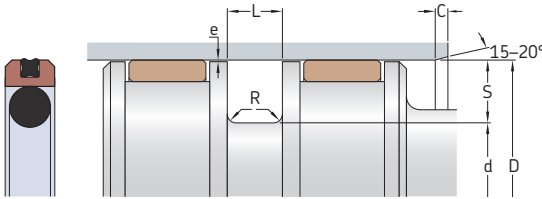

Maximum extrusion gap e

Radial depth S	e _{max} at 80 °C (175 °F) for pressures		
	70 bar	200 bar	350 bar
mm	mm		
5,5	0,46	0,15	0,1
7,75	0,6	0,2	0,13
10,5	0,76	0,25	0,15

For additional information → [page 34](#)

Dimensions						Designation
D H9	d h9	L +0,2	S	R max.	C min.	
mm						-
95	79,5	6,3	7,75	0,6	4	APR-95x79.5x6.3-AD1
100	84,5	6,3	7,75	0,6	4	• APR-100x84.5x6.3-AD1
105	89,5	6,3	7,75	0,6	4	APR-105x89.5x6.3-AD1
110	94,5	6,3	7,75	0,6	4	APR-110x94.5x6.3-AD1
115	99,5	6,3	7,75	0,6	4	APR-115x99.5x6.3-AD1
120	104,5	6,3	7,75	0,6	4	APR-120x104.5x6.3-AD1
125	109,5	6,3	7,75	0,6	4	• APR-125x109.5x6.3-AD1
130	114,5	6,3	7,75	0,6	4	APR-130x114.5x6.3-AD1
132	116,5	6,3	7,75	0,6	4	APR-132x116.5x6.3-AD1
135	119,5	6,3	7,75	0,6	4	APR-135x119.5x6.3-AD1
140	124,5	6,3	7,75	0,6	4	APR-140x124.5x6.3-AD1
145	129,5	6,3	7,75	0,6	4	APR-145x129.5x6.3-AD1
150	134,5	6,3	7,75	0,6	4	APR-150x134.5x6.3-AD1
155	139,5	6,3	7,75	0,6	4	APR-155x139.5x6.3-AD1
160	139	8,1	10,5	0,75	4	• APR-160x139x8.1-AD1
165	144	8,1	10,5	0,75	4	APR-165x144x8.1-AD1
170	149	8,1	10,5	0,75	4	APR-170x149x8.1-AD1
175	154	8,1	10,5	0,75	4	APR-175x154x8.1-AD1
180	159	8,1	10,5	0,75	4	APR-180x159x8.1-AD1
190	169	8,1	10,5	0,75	4	APR-190x169x8.1-AD1

Other sizes are available on request

• Seal housing dimensions in accordance with ISO 7425-1

2.6 APR profile piston seals, inch sizes

D 1 – 6 in.

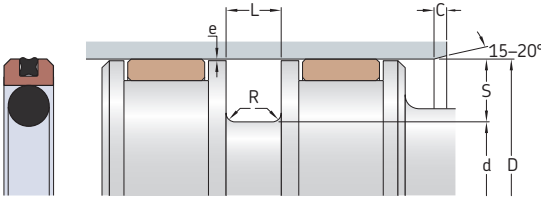

Maximum extrusion gap e

Radial Series e_{\max} at 80 °C (175 °F)
depth for pressures
S 1 000 psi 3 000 psi 5 075 psi

in.	-	in.		
0.212	APR2	0.018	0.006	0.004
0.308	APR3	0.024	0.008	0.005
0.42	APR4	0.03	0.01	0.006
0.46	APR5	0.03	0.01	0.006

For additional information → page 34

2.6

Dimensions								Designation
D	Tolerance	d	Tolerance	L +0.005	S	R max.	C min.	
in.								-
1	+0.003	0.576	-0.003	0.21	0.212	0.015	0.156	APR2-1000-AD1
1.25	+0.003	0.826	-0.003	0.21	0.212	0.015	0.156	APR2-1250-AD1
1.5	+0.003	1.076	-0.003	0.21	0.212	0.015	0.156	APR2-1500-AD1
1.75	+0.003	1.326	-0.003	0.21	0.212	0.015	0.156	APR2-1750-AD1
2	+0.003	1.576	-0.003	0.21	0.212	0.015	0.156	APR2-2000-AD1
2.25	+0.004	1.634	-0.004	0.288	0.308	0.025	0.187	APR3-2250-AD1
2.5	+0.004	1.884	-0.004	0.288	0.308	0.025	0.187	APR3-2500-AD1
2.75	+0.004	2.134	-0.004	0.288	0.308	0.025	0.187	APR3-2750-AD1
3	+0.004	2.384	-0.004	0.288	0.308	0.025	0.187	APR3-3000-AD1
3.25	+0.004	2.634	-0.004	0.288	0.308	0.025	0.187	APR3-3250-AD1
3.5	+0.004	2.884	-0.004	0.288	0.308	0.025	0.187	APR3-3500-AD1
3.75	+0.004	3.134	-0.004	0.288	0.308	0.025	0.187	APR3-3750-AD1
4	+0.004	3.384	-0.004	0.288	0.308	0.025	0.187	APR3-4000-AD1
4.25	+0.004	3.634	-0.004	0.288	0.308	0.025	0.187	APR3-4250-AD1
4.5	+0.004	3.884	-0.004	0.288	0.308	0.025	0.187	APR3-4500-AD1
4.75	+0.004	4.134	-0.004	0.288	0.308	0.025	0.187	APR3-4750-AD1
5	+0.004	4.384	-0.004	0.288	0.308	0.025	0.187	APR3-5000-AD1
5.25	+0.004	4.634	-0.004	0.288	0.308	0.025	0.187	APR3-5250-AD1
5.5	+0.005	4.66	-0.005	0.375	0.42	0.035	0.25	APR4-5500-AD1
5.75	+0.005	4.91	-0.005	0.375	0.42	0.035	0.25	APR4-5750-AD1
6	+0.005	5.16	-0.005	0.375	0.42	0.035	0.25	APR4-6000-AD1

2.6 APR profile piston seals, inch sizes

D 6.25 – 14 in.

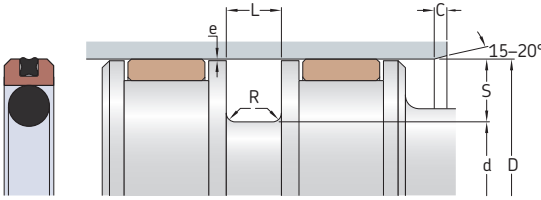

Maximum extrusion gap e

Radial Series e_{\max} at 80 °C (175 °F)
depth for pressures

1 000 psi 3 000 psi 5 075 psi

in. - in.

0.212	APR2	0.018	0.006	0.004
0.308	APR3	0.024	0.008	0.005
0.42	APR4	0.03	0.01	0.006
0.46	APR5	0.03	0.01	0.006

For additional information → page 34

Dimensions

Designation

D	Tolerance	d	Tolerance	L	S	R	C	Designation
in.				+0.005		max.	min.	-
6.25	+0.005	5.41	-0.005	0.375	0.42	0.035	0.25	APR4-6250-AD1
6.5	+0.005	5.66	-0.005	0.375	0.42	0.035	0.25	APR4-6500-AD1
6.75	+0.005	5.91	-0.005	0.375	0.42	0.035	0.25	APR4-6750-AD1
7	+0.005	6.16	-0.005	0.375	0.42	0.035	0.25	APR4-7000-AD1
7.25	+0.005	6.41	-0.005	0.375	0.42	0.035	0.25	APR4-7250-AD1
7.5	+0.005	6.66	-0.005	0.375	0.42	0.035	0.25	APR4-7500-AD1
7.75	+0.005	6.91	-0.005	0.375	0.42	0.035	0.25	APR4-7750-AD1
8	+0.006	7.16	-0.006	0.375	0.42	0.035	0.25	APR4-8000-AD1
8.5	+0.006	7.66	-0.006	0.375	0.42	0.035	0.25	APR4-8500-AD1
9	+0.006	8.16	-0.006	0.375	0.42	0.035	0.25	APR4-9000-AD1
9.5	+0.006	8.66	-0.006	0.375	0.42	0.035	0.25	APR4-9500-AD1
10	+0.006	9.16	-0.006	0.375	0.42	0.035	0.25	APR4-10000-AD1
10.5	+0.008	9.58	-0.008	0.375	0.46	0.035	0.25	APR5-10500-AD1
11	+0.008	10.08	-0.008	0.375	0.46	0.035	0.25	APR5-11000-AD1
11.5	+0.008	10.58	-0.008	0.375	0.46	0.035	0.25	APR5-11500-AD1
12	+0.008	11.08	-0.008	0.375	0.46	0.035	0.25	APR5-12000-AD1
12.5	+0.008	11.58	-0.008	0.375	0.46	0.035	0.25	APR5-12500-AD1
13	+0.008	12.08	-0.008	0.375	0.46	0.035	0.25	APR5-13000-AD1
13.5	+0.008	12.58	-0.008	0.375	0.46	0.035	0.25	APR5-13500-AD1
14	+0.008	13.08	-0.008	0.375	0.46	0.035	0.25	APR5-14000-AD1

Other sizes are available on request

LCP profile data



Material codes	Slide ring: 741 Energizer: A-8501 Anti-extrusion rings: P-2506 For additional information → page 26
Pressure	Up to 690 bar (10 000 psi)
Speed	Up to 1,5 m/s (4.9 ft/s)
Temperature range	<div style="display: flex; align-items: center;"> </div> <p>For temperature limits depending on fluid compatibility → table 8, page 32</p> <ul style="list-style-type: none"> Extreme low temperature range: may be intermittently exposed (e.g. cold start-up) without seal damage, but seal performance may be compromised while in this range Temperatures below the recommended operating range: seal performance depends on system design (precision guiding arrangement recommended) Recommended operating temperature range for this profile and material Temperatures above the recommended operating range: acceptable only with reduced pressure and/or speed Extreme high temperature range: only occasional short-term exposure
Dimension standards	Some metric sizes fit seal housings in accordance with ISO 5597.
Counter-surface	→ page 22

Maximum values of application parameters (e.g. pressure, speed, temperature, e-gap) should not be applied continuously nor simultaneously.

2.7 LCP profile piston seals, metric sizes

D 25 – 200 mm

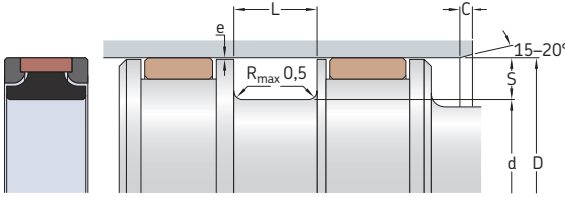

Maximum extrusion gap e

Radial depth S e_{max} at 80 °C (175 °F) for pressures 160 bar 250 bar 400 bar 690 bar

mm	mm			
5	0,7	0,45	0,25	0,15
6,15	0,7	0,45	0,25	0,15
7,5	1	0,65	0,4	0,2
9,25	1,4	0,9	0,55	0,25
10	1,4	0,9	0,55	0,25

For additional information → page 34

2.7

Dimensions

Designation

D H9	d h9	L +0,2	S	C min.	
mm					-
25	15	8	5	4	• LCP-25x15x8-ND1
32	22	8	5	4	• LCP-32x22x8-ND1
40	30	8	5	4	• LCP-40x30x8-ND1
50	40	8	5	4	• LCP-50x40x8-ND1
60	50	8	5	4	LCP-60x50x8-ND1
80	65	12,5	7,5	5	• LCP-80x65x12.5-ND1
90	75	12,5	7,5	5	LCP-90x75x12.5-ND1
100	85	12,5	7,5	5	• LCP-100x85x12.5-ND1
110	95	12,5	7,5	5	LCP-110x95x12.5-ND1
	97,7	14,7	6,15	5	LCP-110x97.7x14.7-ND1
120	105	12,5	7,5	6,5	LCP-120x105x12.5-ND1
125	110	12,5	7,5	6,5	LCP-125x110x12.5-ND1
140	121,5	19	9,25	6,5	LCP-140x121.5x19-ND1
	125	12,5	7,5	6,5	LCP-140x125x12.5-ND1
150	135	12,5	7,5	6,5	LCP-150x135x12.5-ND1
160	141,5	19	9,25	6,5	LCP-160x141.5x19-ND1
	145	12,5	7,5	6,5	LCP-160x145x12.5-ND1
170	155	12,5	7,5	6,5	LCP-170x155x12.5-ND1
180	165	12,5	7,5	6,5	LCP-180x165x12.5-ND1
200	180	16	10	6,5	LCP-200x180x16-ND1
	181,5	19	9,25	6,5	LCP-200x181.5x19-ND1

• Seal housing dimensions in accordance with ISO 5597

2.7 LCP profile piston seals, metric sizes

D 250 – 290 mm

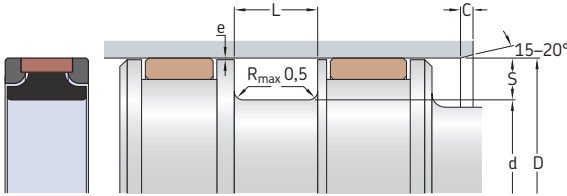

Maximum extrusion gap e

Radial depth e_{\max} at 80 °C (175 °F)
 S for pressures 160 bar 250 bar 400 bar 690 bar

mm	mm			
5	0,7	0,45	0,25	0,15
6,15	0,7	0,45	0,25	0,15
7,5	1	0,65	0,4	0,2
9,25	1,4	0,9	0,55	0,25
10	1,4	0,9	0,55	0,25

For additional information → page 34

Dimensions

D	d	L	S	C
H9	h9	+0,2		min.

mm

Designation

250	230	16	10	6,5	LCP-250x230x16-ND1
290	270	16	10	7,5	LCP-290x270x16-ND1

Other sizes are available on request

2.7 LCP profile piston seals, inch sizes

D 3 – 16 in.

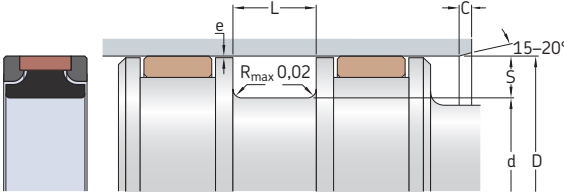

Maximum extrusion gap e

Radial depth	Series	e_{\max} at 80 °C (175 °F) for pressures			
		2 300 psi	3 600 psi	5 800 psi	10 000 psi
S					
in.	-	in.			

0.187	LCP3	0.026	0.017	0.01	0.006
0.24	LCP4	0.04	0.025	0.016	0.009
0.365	LCP6	0.053	0.034	0.021	0.012
0.42	LCP8	0.067	0.043	0.027	0.015

For additional information → page 34

Dimensions							Designation
D	Tolerance	d	Tolerance	L	S	C	
				+0.01		min.	
in.							-
3	+0.003	2.52	-0.003	0.579	0.24	0.2	LCP4-3000-ND1
4	+0.003	3.52	-0.003	0.579	0.24	0.2	LCP4-4000-ND1
4.5	+0.003	4.02	-0.003	0.579	0.24	0.2	LCP4-4500-ND1
5	+0.004	4.27	-0.004	0.75	0.365	0.25	LCP6-5000-ND1
5.5	+0.004	4.77	-0.004	0.75	0.365	0.25	LCP6-5500-ND1
6	+0.004	5.27	-0.004	0.75	0.365	0.25	LCP6-6000-ND1
7	+0.004	6.27	-0.004	0.75	0.365	0.25	LCP6-7000-ND1
8	+0.004	7.27	-0.004	0.75	0.365	0.25	LCP6-8000-ND1
9	+0.004	8.27	-0.004	0.75	0.365	0.25	LCP6-9000-ND1
10	+0.004	9.27	-0.004	0.75	0.365	0.25	LCP6-10000-ND1
13	+0.004	12.27	-0.004	0.75	0.365	0.25	LCP6-13000-ND1
14	+0.004	13.27	-0.004	0.75	0.365	0.25	LCP6-14000-ND1
16	+0.004	15.27	-0.004	0.75	0.365	0.25	LCP6-16000-ND1

Other sizes are available on request

LTP profile data



Material codes	Sealing ring: A-8501 Anti-extrusion rings: P-2506 For additional information → page 26
Pressure	Up to 345 bar (5 000 psi)
Speed	Pressure ≤ 250 bar (3 625 psi) → up to 1 m/s (3.2 ft/s) Pressure > 250 bar (3 625 psi) → up to 0,5 m/s (1.6 ft/s)
Temperature range	<p>For temperature limits depending on fluid compatibility → table 8, page 32</p> <ul style="list-style-type: none"> ■ Extreme low temperature range: may be intermittently exposed (e.g. cold start-up) without seal damage, but seal performance may be compromised while in this range ■ Temperatures below the recommended operating range: seal performance depends on system design (precision guiding arrangement recommended) ■ Recommended operating temperature range for this profile and material ■ Temperatures above the recommended operating range: acceptable only with reduced pressure, speed, and/or e-gap ■ Extreme high temperature range: only occasional short-term exposure (e.g. cylinder in curing oven of a powder coating process)
Counter-surface	→ page 22

Maximum values of application parameters (e.g. pressure, speed, temperature, e-gap) should not be applied continuously nor simultaneously.

2.8 LTP profile piston seals, inch sizes

D 0.625 – 2.875 in.

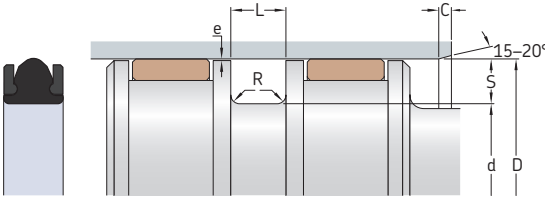

Maximum extrusion gap e

Radial Series e_{\max} at 80 °C (175 °F)
depth for pressures

1 000 psi 3 000 psi 5 000 psi

in. - in.

0.125	2	0.025	0.008	0.005
0.187	3	0.03	0.012	0.007
0.25	4	0.035	0.017	0.01

For additional information → page 34

2.8

Dimensions							Designation
D +0.002	d	Tolerance	L +0.005	S	R max.	C min.	
in.							-
0.625	0.383	-0.002	0.187	0.125	0.02	0.125	LTP-204-E3R
0.75	0.508	-0.002	0.187	0.125	0.02	0.125	LTP-206-E3R
0.875	0.633	-0.002	0.187	0.125	0.02	0.125	LTP-208-E3R
0.937	0.695	-0.002	0.187	0.125	0.02	0.125	LTP-209-E3R
1	0.758	-0.002	0.187	0.125	0.02	0.125	LTP-210-E3R
1.062	0.82	-0.002	0.187	0.125	0.02	0.125	LTP-211-E3R
1.125	0.883	-0.002	0.187	0.125	0.02	0.125	LTP-212-E3R
1.25	1.008	-0.002	0.187	0.125	0.02	0.125	LTP-214-E3R
1.375	1.133	-0.002	0.187	0.125	0.02	0.125	LTP-216-E3R
1.5	1.258	-0.002	0.187	0.125	0.02	0.125	LTP-218-E3R
1.625	1.383	-0.002	0.187	0.125	0.02	0.125	LTP-220-E3R
1.75	1.508	-0.002	0.187	0.125	0.02	0.125	LTP-222-E3R
1.875	1.505	-0.002	0.281	0.187	0.025	0.125	LTP-325-E3R
2	1.63	-0.002	0.281	0.187	0.025	0.125	LTP-326-E3R
2.125	1.755	-0.002	0.281	0.187	0.025	0.125	LTP-327-E3R
2.25	1.88	-0.002	0.281	0.187	0.025	0.125	LTP-328-E3R
2.375	2.005	-0.002	0.281	0.187	0.025	0.125	LTP-329-E3R
2.5	2.13	-0.002	0.281	0.187	0.025	0.125	LTP-330-E3R
2.625	2.255	-0.002	0.281	0.187	0.025	0.125	LTP-331-E3R
2.75	2.38	-0.002	0.281	0.187	0.025	0.125	LTP-332-E3R
2.875	2.505	-0.002	0.281	0.187	0.025	0.125	LTP-333-E3R

2.8 LTP profile piston seals, inch sizes

D 3 – 12.002 in.

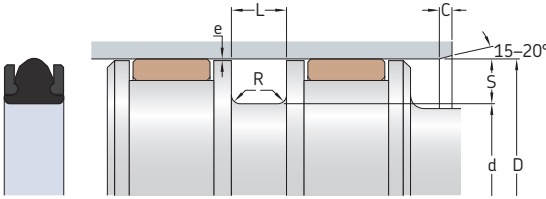

Maximum extrusion gap e

Radial Series e_{\max} at 80 °C (175 °F)
depth for pressures
S 1 000 psi 3 000 psi 5 000 psi

in. – in.

0.125	2	0.025	0.008	0.005
0.187	3	0.03	0.012	0.007
0.25	4	0.035	0.017	0.01

For additional information → [page 34](#)

Dimensions

Designation

D +0.002	d	Tolerance	L +0.005	S	R max.	C min.	Designation
in.							–
3	2.63	-0.002	0.281	0.187	0.025	0.125	LTP-334-E3R
3.125	2.755	-0.002	0.281	0.187	0.025	0.125	LTP-335-E3R
3.25	2.88	-0.002	0.281	0.187	0.025	0.125	LTP-336-E3R
3.5	3.13	-0.002	0.281	0.187	0.025	0.125	LTP-338-E3R
3.75	3.38	-0.002	0.281	0.187	0.025	0.125	LTP-340-E3R
3.875	3.505	-0.002	0.281	0.187	0.025	0.125	LTP-341-E3R
4	3.63	-0.002	0.281	0.187	0.025	0.125	LTP-342-E3R
4.125	3.755	-0.002	0.281	0.187	0.025	0.125	LTP-343-E3R
4.25	3.88	-0.002	0.281	0.187	0.025	0.125	LTP-344-E3R
4.5	4.13	-0.002	0.281	0.187	0.025	0.125	LTP-346-E3R
4.75	4.38	-0.002	0.281	0.187	0.025	0.125	LTP-348-E3R
4.875	4.505	-0.002	0.281	0.187	0.025	0.125	LTP-349-E3R
5	4.63	-0.002	0.281	0.187	0.025	0.125	LTP-350-E3R
5.252	4.778	-0.004	0.375	0.25	0.032	0.187	LTP-427-E3R
5.377	4.903	-0.004	0.375	0.25	0.032	0.187	LTP-428-E3R
5.502	5.028	-0.004	0.375	0.25	0.032	0.187	LTP-429-E3R
5.627	5.153	-0.004	0.375	0.25	0.032	0.187	LTP-430-E3R
5.752	5.278	-0.004	0.375	0.25	0.032	0.187	LTP-431-E3R
6.002	5.528	-0.004	0.375	0.25	0.032	0.187	LTP-433-E3R
6.377	6.028	-0.004	0.375	0.25	0.032	0.187	LTP-437-E3R
7.002	6.528	-0.004	0.375	0.25	0.032	0.187	LTP-439-E3R

Dimensions							Designation
D +0.002	d	Tolerance	L +0.005	S	R max.	C min.	
in.							-
7.752	7.278	-0.004	0.375	0.25	0.032	0.187	LTP-442-E3R
9.502	9.028	-0.004	0.375	0.25	0.032	0.187	LTP-447-E3R
10.002	9.528	-0.004	0.375	0.25	0.032	0.187	LTP-448-E3R
12.002	11.528	-0.004	0.375	0.25	0.032	0.187	LTP-452-E3R

Other sizes are available on request

CUT profile data



Material codes	Slide ring: PA66/011 Energizer: N70/015 For additional information → page 26
Pressure	Up to 500 bar (7 250 psi)
Speed	Up to 1 m/s (3.2 ft/s)
Temperature range	<p>For temperature limits depending on fluid compatibility → table 8, page 32</p> <ul style="list-style-type: none"> ■ Extreme low temperature range: may be intermittently exposed (e.g. cold start-up) without seal damage, but seal performance may be compromised while in this range ■ Temperatures below the recommended operating range: seal performance depends on system design (precision guiding arrangement recommended) ■ Recommended operating temperature range for this profile and material ■ Temperatures above the recommended operating range: acceptable only with reduced pressure and/or speed ■ Extreme high temperature range: only occasional short-term exposure
Dimension standards	Some sizes fit seal housings in accordance with ISO 7425-1.
Counter-surface	→ page 22

Maximum values of application parameters (e.g. pressure, speed, temperature) should not be applied continuously nor simultaneously.

2.9 CUT profile piston seals, metric sizes

D 40 – 140 mm

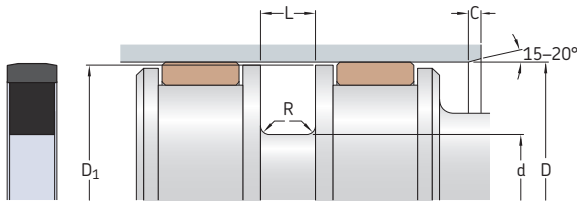

2.9

Dimensions						Designation
D H9	d h9	L +0,2	D ₁	R max.	C min.	
mm						-
40	29	4,2	39,2	0,3	7	• CUT 40x29x4.2
50	34,5	6,3	49	0,5	10	• CUT 50x34.5x6.3
	39	4,2	49,2	0,3	7	• CUT 50x39x4.2
60	41,7	7,0	59	0,5	10	CUT 60x41.7x7.0
63	44,7	7,0	62	0,5	10	CUT 63x44.7x7
	47,5	6,3	62	0,5	10	• CUT 63x47.5x6.3
65	49,5	6,3	64	0,5	10	CUT 65x49.5x6.3
70	51,7	7,0	69	0,5	10	CUT 70x51.7x7
75	54	8,1	73,8	0,9	12	CUT 75x54x8.1
	59,5	6,3	74	0,5	10	CUT 75x59.5x6.3
80	59	8,1	78,8	0,9	12	CUT 80x59x8.1
	64,5	6,3	79	0,5	10	• CUT 80x64.5x6.3
90	69	8,1	88,8	0,9	12	CUT 90x69x8.1
	74,5	6,3	89	0,5	10	CUT 90x74.5x6.3
100	79	8,1	98,8	0,9	12	CUT 100x79x8.1
	84,5	6,3	99	0,5	10	• CUT 100x84.5x6.3
110	89	8,1	108,8	0,9	12	CUT 110x89x8.1
115	94	8,1	113,8	0,9	12	CUT 115x94x8.1
120	99	8,1	118,8	0,9	12	CUT 120x99x8.1
125	104	8,1	123,8	0,9	12	• CUT 125x104x8.1
	109,5	6,3	124	0,5	10	• CUT 125x109.5x6.3
130	109	8,1	128,8	0,9	12	CUT 130x109x8.1
140	119	8,1	138,8	0,9	12	CUT 140x119x8.1

• Seal housing dimensions in accordance with ISO 7425-1

2.9 CUT profile piston seals, metric sizes

D 150 – 320 mm

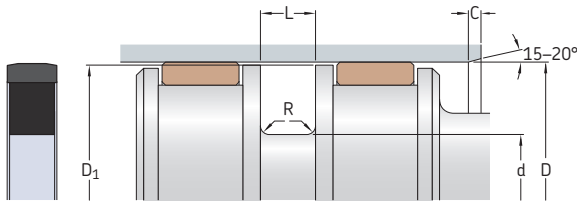

Dimensions						Designation
D H9	d h9	L +0,2	D ₁	R max.	C min.	
mm						-
150	129	8,1	148,8	0,9	12	CUT 150x129x8.1
160	139	8,1	158,8	0,9	12	• CUT 160x139x8.1
170	149	8,1	168,8	0,9	12	CUT 170x149x8.1
180	159	8,1	178,8	0,9	12	CUT 180x159x8.1
190	169	8,1	188,8	0,9	12	CUT 190x169x8.1
200	179	8,1	198,8	0,9	12	• CUT 200x179x8.1
210	189	8,1	198,8	0,9	12	CUT 210x189x8.1
220	199	8,1	218,8	0,9	12	CUT 220x199x8.1
230	209	8,1	228,8	0,9	12	CUT 230x209x8.1
240	219	8,1	238,8	0,9	12	CUT 240x219x8.1
	225	8,1	239	0,9	12	CUT 240x225x8.1
250	229	8,1	248,8	0,9	12	• CUT 250x229x8.1
260	239	8,1	258,8	0,9	12	CUT 260x239x8.1
280	255,5	8,1	278,8	0,9	12	CUT 280x255.5x8.1
320	292	9,5	318,4	0,9	15	CUT 320x292x9.5

Other sizes are available on request

• Seal housing dimensions in accordance with ISO 7425-1

SCP profile data



Material codes	Slide ring: suffix E5E → P-2501 suffix E5D → P-2551 Energizer: A-8526 For additional information → page 26
Pressure	Up to 690 bar (10 000 psi)
Speed	Up to 1 m/s (3.2 ft/s)
Temperature range	<div style="display: flex; align-items: center;">  <div style="margin-left: 20px;"> <p>110 120 130 [°C]</p> <p>230 250 265 [°F]</p> </div> </div> <p>For temperature limits depending on fluid compatibility → table 8, page 32</p> <ul style="list-style-type: none"> Extreme low temperature range: may be intermittently exposed (e.g. cold start-up) without seal damage, but seal performance may be compromised while in this range Temperatures below the recommended operating range: seal performance depends on system design (precision guiding arrangement recommended) Recommended operating temperature range for this profile and material Temperatures above the recommended operating range: acceptable only with reduced pressure and/or speed Extreme high temperature range: only occasional short-term exposure
Counter-surface	→ page 22

Maximum values of application parameters (e.g. pressure, speed, temperature) should not be applied continuously nor simultaneously.

2.10 SCP profile piston seals, inch sizes

D 2 – 5.025 in.

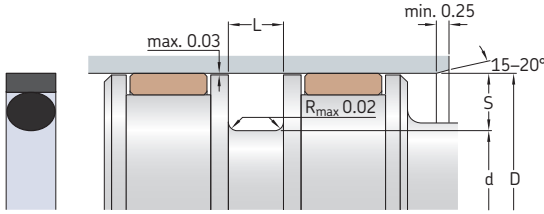

Dimensions					Designation	
D	Tolerance	d	Tolerance	L +0.005	S	
in.						-
2	+0.002	1.462	-0.002	0.282	0.269	SCP1-2000-E5E
2.25	+0.002	1.712	-0.002	0.282	0.269	SCP1-2250-E5E
2.5	+0.003	1.908	-0.002	0.312	0.296	SCP5-2500-E5E
	+0.003	1.962	-0.002	0.282	0.269	SCP1-2500-E5E
2.75	+0.003	2.212	-0.002	0.282	0.269	SCP1-2750-E5D
3	+0.003	2.408	-0.002	0.312	0.296	SCP5-3000-E5E
	+0.003	2.442	-0.003	0.282	0.279	SCP2-3000-E5E
3.25	+0.003	2.692	-0.003	0.282	0.279	SCP2-3250-E5E
3.5	+0.003	2.908	-0.003	0.312	0.296	SCP5-3500-E5E
	+0.003	2.942	-0.003	0.282	0.279	SCP2-3500-E5E
3.75	+0.003	3.192	-0.003	0.282	0.279	SCP2-3750-E5D
4	+0.003	3.408	-0.003	0.312	0.296	SCP5-4000-E5E
	+0.003	3.442	-0.003	0.282	0.279	SCP2-4000-E5E
4.025	+0.003	3.467	-0.003	0.282	0.279	SCP2-4025-E5D
4.25	+0.003	3.692	-0.003	0.282	0.279	SCP2-4250-E5D
4.265	+0.003	3.707	-0.003	0.282	0.279	SCP2-4265-E5D
4.5	+0.003	3.74	-0.003	0.377	0.38	SCP3-4500-E5D
	+0.003	3.908	-0.003	0.312	0.296	SCP5-4500-E5E
	+0.003	3.942	-0.003	0.282	0.279	SCP2-4500-E5E
4.525	+0.003	3.967	-0.003	0.282	0.279	SCP2-4525-E5D
4.75	+0.003	3.99	-0.004	0.377	0.38	SCP3-4750-E5D
	+0.003	4.192	-0.004	0.282	0.279	SCP2-4750-E5E
5	+0.004	4.24	-0.004	0.377	0.38	SCP3-5000-E5E
	+0.004	4.442	-0.004	0.282	0.279	SCP2-5000-E5E
5.025	+0.004	4.265	-0.004	0.377	0.38	SCP3-5025-E5D

2.10 SCP profile piston seals, inch sizes

D 5.25 – 12 in.

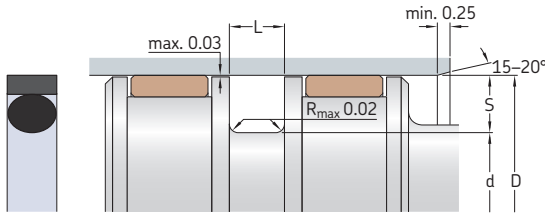

Dimensions						Designation
D	Tolerance	d	Tolerance	L +0.005	S	
in.						-
5.25	+0.004	4.49	-0.004	0.377	0.38	SCP3-5250-E5D
5.5	+0.004	4.74	-0.004	0.377	0.38	SCP3-5500-E5E
5.75	+0.004	4.99	-0.004	0.377	0.38	SCP3-5750-E5D
6	+0.004	5.24	-0.004	0.377	0.38	SCP3-6000-E5E
6.025	+0.004	5.265	-0.004	0.377	0.38	SCP3-6025-E5D
6.5	+0.004	5.74	-0.004	0.377	0.38	SCP3-6500-E5D
7	+0.004	6.24	-0.004	0.377	0.38	SCP3-7000-E5E
7.025	+0.004	6.265	-0.004	0.377	0.38	SCP3-7025-E5D
7.5	+0.004	6.74	-0.004	0.377	0.38	SCP3-7500-E5D
8	+0.004	7.24	-0.004	0.377	0.38	SCP3-8000-E5D
8.5	+0.004	7.74	-0.004	0.377	0.38	SCP3-8500-E5D
9	+0.004	8.124	-0.004	0.377	0.438	SCP4-9000-E5D
9.5	+0.004	8.624	-0.004	0.377	0.438	SCP4-9500-E5D
10	+0.004	9.124	-0.004	0.377	0.438	SCP4-10000-E5D
12	+0.004	11.124	-0.004	0.377	0.438	SCP4-12000-E5D

Other sizes are available on request

MD-L profile data



Material codes	Sealing ring: N80/047 Guide rings: POM/076 Support rings: TPC-ET72/075 For additional information → page 26
Pressure	Up to 250 bar (3 625 psi)
Speed	Up to 1 m/s (3.2 ft/s)
Temperature range	<p>For temperature limits depending on fluid compatibility → table 8, page 32</p> <ul style="list-style-type: none"> ■ Extreme low temperature range: may be intermittently exposed (e.g. cold start-up) without seal damage, but seal performance may be compromised while in this range ■ Temperatures below the recommended operating range: seal performance depends on system design ■ Recommended operating temperature range for this profile and material ■ Temperatures above the recommended operating range: acceptable only with reduced pressure and/or speed ■ Extreme high temperature range: only occasional short-term exposure (e.g. cylinder in curing oven of a powder coating process)
Dimension standards	Some sizes fit seal housings in accordance with ISO 6547.
Counter-surface	→ page 22

Maximum values of application parameters (e.g. pressure, speed, temperature) should not be applied continuously nor simultaneously.

2.11 MD-L profile piston seals, metric sizes

D 25 – 63 mm

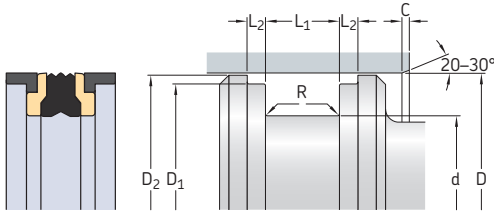

Dimensions								Designation
D H9	d h9	L ₁ +0,1/+0,35	L ₂ +0,1	D ₁ h9	D ₂ h11	R max.	C min.	
mm								-
25	15	12,4	4	21	23	0,4	2,5	MD 25x15x12.4-L
30	21	13,5	2,1	27	29	0,4	2,5	MD 30x21x13.5-L
32	22	12,5	4	29	31	0,4	2,5	• MD 32x22x12.5-L
24	10	4	29	31	0,4	2		• MD 32x24x10-L
24	15,5	3,2	28	31,4	0,4	2		MD 32x24x15.5-L
35	25	15,5	2,6	31	34	0,4	2,5	MD 35x25x15.5-L
	25	16,4	6,4	31,4	33,5	0,4	2,5	MD 35x25x16.4-L
40	24	18,4	6,4	35,4	38,7	0,4	4	MD 40x24x18.4-L
30	12,4	4	36	38	0,4	2,5		MD 40x30x12.4-L
30	12,5	4	37	39	0,4	2,5		• MD 40x30x12.5-L
30	16,4	6,4	35,4	38,7	0,4	2,5		MD 40x30x16.4-L
32	15,5	3,2	36	39,4	0,4	2		MD 40x32x15.5-L
45	29	18,4	6,4	40,4	43,7	0,4	4	MD 45x29x18.4-L
37	15,5	3,2	41,0	43,5	0,4	2		MD 45x37x15.5-L
50	34	18,4	6,4	45,4	48,7	0,4	4	MD 50x34x18.4-L
35	20	5	46	48,5	0,4	4		• MD 50x35x20-L
38	20,5	4,2	46	49,4	0,4	3		MD 50x38x20.5-L
40	12,5	4	47	49	0,4	2,5		• MD 50x40x12.5-L
55	39	18,4	6,4	50,4	53,7	0,4	4	MD 55x39x18.4-L
39	20,5	3,1	51	54	0,4	4		MD 55x39x20.5-L
45	12,5	4	52	54	0,4	2,5		MD 55x45x12.5-L
60	44	18,4	6,4	55,4	58,7	0,4	4	MD 60x44x18.4-L
48	20,5	4,2	56	59,4	0,4	3		MD 60x48x20.5-L
50	17	4	56	59,4	0,4	2,5		MD 60x50x17-L
63	47	18,4	6,4	58,4	61,5	0,4	4	MD 63x47x18.4-L
47	19,4	6,4	58,4	61,7	0,4	4		MD 63x47x19.4-L
47	20,5	3,1	59	62	0,4	4		MD 63x47x20.5-L
48	20	5,0	59	61,5	0,4	4		• MD 63x48x20-L
51	20,5	4,2	59	62,4	0,4	3		MD 63x51x20.5-L
53	12,5	4	60	62	0,4	2,5		• MD 63x53x12.5-L

• Dimensions in accordance with ISO 6547

2.11 MD-L profile piston seals, metric sizes D 65 – 280 mm

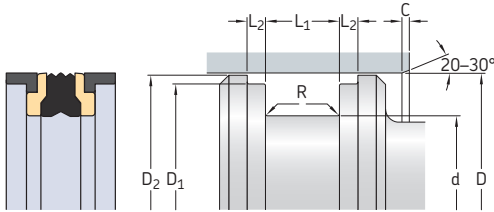

Dimensions								Designation
D H9	d h9	L ₁ +0,1/+0,35	L ₂ +0,1	D ₁ h9	D ₂ h11	R max.	C min.	
mm								-
65	50	18,4	6,4	60,4	63,7	0,4	4	MD 65x50x18.4-L
70	50	22,4	6,4	64,2	68,3	0,8	5	MD 70x50x22.4-L
	54	20,5	3,1	66	69	0,4	4	MD 70x54x20.5-L
	55	20	5	66	68,5	0,4	4	MD 70x55x20-L
	58	20,5	4,2	66	69,4	0,4	3	MD 70x58x20.5-L
75	55	22,4	6,4	69,2	73,3	0,8	5	MD 75x55x22.4-L
80	60	22,4	6,4	74,2	78,3	0,8	5	MD 80x60x22.4-L
	60	25	6,3	75	78	0,8	5	• MD 80x60x25-L
	62	22,5	3,6	76	79	0,4	4,5	MD 80x62x22.5-L
	65	20	5	76	78,5	0,4	4	• MD 80x65x20-L
	66	22,5	5,2	76	79,4	0,4	3,5	MD 80x66x22.5-L
85	65	22,4	6,4	79,2	83,3	0,8	5	MD 85x65x22.4-L
90	70	22,4	6,4	84,2	88,3	0,8	5	MD 90x70x22.4-L
	72	22,5	3,6	86	89	0,4	4,5	MD 90x72x22.5-L
	75	20	5	86	88,5	0,4	4	MD 90x75x20-L
95	75	22,4	6,4	89	93,3	0,8	5	MD 95x75x22.4-L
100	75	22,4	6,4	93,2	98	0,8	6,5	MD 100x75x22.4-L
	80	25	6,3	95	98	0,8	5	• MD 100x80x25-L
	85	20	5	96	98,5	0,4	4	• MD 100x85x20-L
	86	22,5	5,2	96	99,4	0,4	3,5	MD 100x86x22.5-L
105	92,5	14,0	5,2	99,0	103,5	0,4	3,5	MD 105x92.5x14-L
110	85	22,4	6,4	103,1	108	0,8	6,5	MD 110x85x22.4-L
	85	25,4	6,4	103,1	108	0,8	6,5	MD 110x85x25.4-L
	95	20	5	106	108,5	0,4	4	MD 110x95x20-L
	96	22,5	5,2	106	109,4	0,4	3,5	MD 110x96x22.5-L
115	90	22,4	6,4	108,1	113	0,8	6,5	MD 115x90x22.4-L
120	95	22,4	6,4	113,1	118	0,8	6,5	MD 120x95x22.4-L

• Dimensions in accordance with ISO 6547

Dimensions								Designation
D H9	d h9	L ₁ +0,1/+0,35	L ₂ +0,1	D ₁ h9	D ₂ h11	R max.	C min.	
mm								-
125	100	25,4	6,4	118,1	123	0,8	6,5	MD 125x100x25.4-L
	100	32	10	119	123	0,8	6,5	• MD 125x100x32-L
	105	25	6,3	120	123	0,8	5	• MD 125x105x25-L
	105	25,4	6,4	119,1	123,3	0,8	5	MD 125x105x25.4-L
	108	26,5	7,2	121	124,4	0,4	4,5	MD 125x108x26.5-L
130	105	25,4	6,4	123,1	128	0,8	6,5	MD 130x105x25.4-L
	105	25,4	9,5	124,1	128,3	0,8	6,5	MD 130x105x25.4x9.5-L
140	115	25,4	6,4	133	138	0,8	6,5	MD 140x115x25.4-L
	115	25,4	9,5	132,6	137,5	0,8	6,5	MD 140x115x25.4x9.5-L
	120	25	6,3	135	138	0,8	5	MD 140x120x25-L
145	120	25,4	6,4	138,3	143	0,8	6,5	MD 145x120x25.4-L
150	125	25,4	6,4	143	148	0,8	6,5	MD 150x125x25.4-L
	125	25,4	9,5	142,6	147,5	0,8	6,5	MD 150x125x25.4x9.5-L
160	130	25,4	6,4	153	157,9	0,8	7,5	MD 160x130x25.4-L
	135	25,4	9,5	152,6	157,5	0,8	6,5	MD 160x135x25.4x9.5-L
	140	25	6,3	155	158	0,8	5	• MD 160x140x25-L
165	140	25,4	9,5	157,6	162,5	0,8	6,5	MD 165x140x25.4x9.5-L
170	145	25,4	12,7	161,7	167,1	0,8	6,5	MD 170x145x25.4x12.7-L
180	150	35,4	6,4	173	178	0,8	7,5	MD 180x150x35.4-L
	155	25,4	12,7	171,7	177,7	0,8	6,5	MD 180x155x25.4x12.7-L
190	165	25,4	12,7	181,7	187	0,8	6,5	MD 190x165x25.4x12.7-L
200	170	35,4	6,4	193	198	0,8	7,5	MD 200x170x35.4-L
	170	36	12,5	192	197	0,8	7,5	• MD 200x170x36-L
	175	25,4	12,7	192	197	0,8	6,5	MD 200x175x25.4x12.7-L
	180	31,5	9,2	196	199,4	0,8	5	MD 200x180x31.5-L
220	190	35,4	6,4	213	218	0,8	7,5	MD 220x190x35.4-L
	195	25,4	12,7	211,6	217	0,8	6,5	MD 220x195x25.4x12.7-L
230	205	25,4	12,7	221,6	227	0,8	6,5	MD 230x205x25.4x12.7-L
240	215	25,4	12,7	231,6	237	0,8	6,5	MD 240x215x25.4x12.7-L
250	220	35,4	6,4	243	248	0,8	7,5	MD 250x220x35.4-L
	225	25,4	12,7	241,6	247	0,8	6,5	MD 250x225x25.4x12.7-L
280	250	35,4	9,5	273	277	0,8	7,5	MD 280x250x35.4x9.5-L

Other sizes are available on request

UNP profile data



Material codes	Metric sizes → U-1029 Inch sizes → U-1023 For additional information → page 26
Pressure	Up to 350 bar (5 075 psi)
Speed	Pressure ≤ 250 bar (3 625 psi) → up to 1 m/s (3.2 ft/s) Pressure > 250 bar (3 625 psi) → up to 0,5 m/s (1.6 ft/s)
Temperature range	<p>For temperature limits depending on fluid compatibility → table 8, page 32</p> <ul style="list-style-type: none"> ■ Extreme low temperature range: may be intermittently exposed (e.g. cold start-up) without seal damage, but seal performance may be compromised while in this range ■ Temperatures below the recommended operating range: seal performance depends on system design (precision guiding arrangement recommended) ■ Recommended operating temperature range for this profile and material ■ Temperatures above the recommended operating range: acceptable only with reduced pressure, speed, e-gap and/or with the use of a full-face anti-extrusion ring ■ Extreme high temperature range: only occasional short-term exposure (e.g. cylinder in curing oven of a powder coating process)
Counter-surface	→ page 22

Maximum values of application parameters (e.g. pressure, speed, temperature, e-gap) should not be applied continuously nor simultaneously.

2.12 UNP profile piston seals, metric sizes D 45 – 250 mm

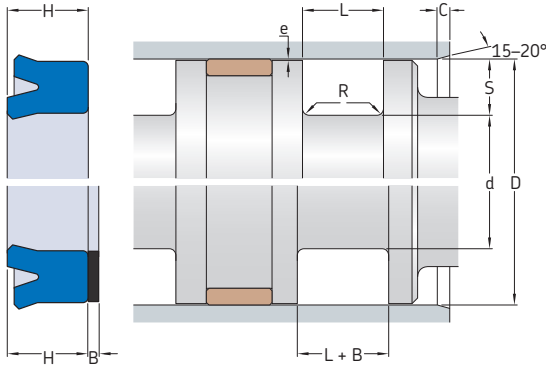

Maximum extrusion gap e

Radial depth S	e _{max} at 80 °C (175 °F) for pressures		
	160 bar	250 bar	350 bar
mm	mm		
5	0,45	0,25	0,1
7,5	0,5	0,3	0,15
10	0,55	0,3	0,15
12,5 to 15	0,6	0,3	0,2

For additional information → page 34

With and without full-face anti-extrusion ring¹⁾

Dimensions								Designation
D	d	L	L + B	H	S	R	C	
H9	h9	+0,2	+0,2	nom.		max.	min.	
mm								-
45	35	7	9	6	5	0,4	5	UNP-45x35x7-E6W
50	40	7	9	6	5	0,4	5	UNP-50x40x7-E6W
	40	8,3	10,3	7,3	5	0,4	5	UNP-50x40x8.3-E6W
63	48	11	13	10	7,5	0,5	7	UNP-63x48x11-E6W
	53	7	9	6	5	0,4	5	UNP-63x53x7-E6W
	53	8,3	10,3	7,3	5	0,4	5	UNP-63x53x8.3-E6W
75	65	7	9	6	5	0,4	5	UNP-75x65x7-E6W
130	115	10	12	9	7,5	0,5	7	UNP-130x115x10-E6W
140	120	16,5	18,5	15	10	0,75	7	UNP-140x120x16.5-E6W
150	135	10	12	9	7,5	0,6	7	UNP-150x135x10-E6W
160	140	16	18	14,5	10	0,75	7	UNP-160x140x15.5-E6W
170	150	13,2	15,2	12	10	0,75	7	UNP-170x150x13-E6W
	155	10	12	9	7,5	0,5	7	UNP-170x155x10-E6W
180	150	20	22	18	15	0,75	7	UNP-180x150x19.5-E6W
	165	10	12	9	7,5	0,5	7	UNP-180x165x10-E6W
190	175	10	12	9	7,5	0,5	7	UNP-190x175x10-E6W
200	175	20,2	22,2	18,2	12,5	0,75	12	UNP-200x175x19.7-E6W
210	190	13,2	15,2	12	10	0,75	7	UNP-210x190x13-E6W
220	200	16,5	18,5	15	10	0,75	7	UNP-220x200x16.5-E6W
230	205	22	24	20	12,5	0,75	12	UNP-230x205x22-E6W
240	220	13,2	15,2	12	10	0,75	7	UNP-240x220x13-E6W
250	230	16,5	18,5	15	10	0,75	7	UNP-250x230x16.5-E6W

¹⁾ In case of higher pressures, SKF provides full-face anti-extrusion rings on request. For additional information, contact SKF.

2.12 UNP profile piston seals, metric sizes

D 280 – 300 mm

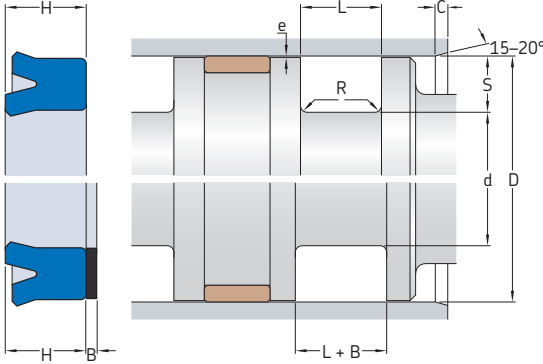

Maximum extrusion gap e

Radial depth S	e _{max} at 80 °C (175 °F) for pressures		
	160 bar	250 bar	350 bar
mm	mm		
5	0,45	0,25	0,1
7,5	0,5	0,3	0,15
10	0,55	0,3	0,15
12,5 to 15	0,6	0,3	0,2

For additional information → page 34

With and without full-face anti-extrusion ring¹⁾

Dimensions

Designation

D	d	L	L + B	H	S	R	C	Designation
H9	h9	+0,2	+0,2	nom.		max.	min.	
mm								
280	255	21	23	19	12,5	0,75	12	UNP-280x255x20.5-E6W
290	265	21	23	19	12,5	0,75	12	UNP-290x265x20.5-E6W
300	275	17,6	19,6	16	12,5	0,75	12	UNP-300x275x17.5-E6W

Other sizes are available on request

¹⁾ In case of higher pressures, SKF provides full-face anti-extrusion rings on request. For additional information, contact SKF.

2.12 UNP profile piston seals, inch sizes

D 1.125 – 5 in.

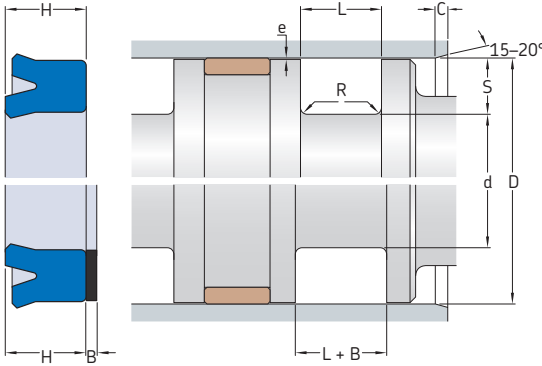

Maximum extrusion gap e

Radial depth S	e _{max} at 80 °C (175 °F) for pressures		
	2 300 psi	3 600 psi	5 075 psi
in.	in.		
0.125	0.008	0.004	–
0.187	0.014	0.008	–
0.25	0.018	0.01	0.004
0.375	0.02	0.012	0.006
0.5	0.022	0.012	0.006

For additional information → page 34

With and without full-face anti-extrusion ring¹⁾

Dimensions

Designation

D	Tolerance	d	Tolerance	L +0.01	L+B +0.01	H nom.	S	R max.	C min.	Designation
in.										–
1.125	+0.002	0.75	-0.002	0.343	0.437	0.312	0.187	0.015	0.25	UNP187-750-312-H9J
1.5	+0.002	1.125	-0.002	0.275	0.369	0.25	0.187	0.015	0.25	UNP187-1125-250-H9J
	+0.002	1.25	-0.002	0.275	0.338	0.25	0.125	0.01	0.25	UNP125-1250-250-H9J
1.75	+0.002	1.375	-0.002	0.275	0.369	0.25	0.187	0.015	0.25	UNP187-1375-250-H9J
2	+0.002	1.625	-0.002	0.206	0.299	0.187	0.187	0.015	0.25	UNP187-1625-187-H9J
	+0.002	1.625	-0.002	0.343	0.437	0.312	0.187	0.015	0.25	UNP187-1625-312-H9J
2.25	+0.002	1.875	-0.002	0.343	0.437	0.312	0.187	0.015	0.25	UNP187-1875-312-H9J
2.5	+0.003	2	-0.003	0.413	0.538	0.375	0.25	0.02	0.312	UNP250-2000-375-H9J
	+0.002	2.125	-0.002	0.275	0.369	0.25	0.187	0.015	0.25	UNP187-2125-250-H9J
	+0.002	2.125	-0.002	0.413	0.506	0.375	0.187	0.015	0.25	UNP187-2125-375-H9J
2.625	+0.002	2.25	-0.002	0.343	0.437	0.312	0.187	0.015	0.25	UNP187-2250-312-H9J
2.75	+0.003	2.25	-0.003	0.413	0.538	0.375	0.25	0.02	0.312	UNP250-2250-375-H9J
3	+0.002	2	-0.007	0.550	0.800	0.5	0.5	0.04	0.375	UNP500-2000-500-H9J
	+0.003	2.5	-0.003	0.343	0.468	0.312	0.25	0.02	0.312	UNP250-2500-312-H9J
	+0.003	2.5	-0.003	0.413	0.538	0.375	0.25	0.02	0.312	UNP250-2500-375-H9J
	+0.002	2.625	-0.002	0.413	0.506	0.375	0.187	0.015	0.25	UNP187-2625-375-H9J
3.25	+0.005	2.25	-0.007	0.550	0.800	0.5	0.5	0.04	0.375	UNP500-2250-500-H9J
	+0.002	2.875	-0.002	0.413	0.506	0.375	0.187	0.015	0.25	UNP187-2875-375-H9J
3.5	+0.004	2.75	-0.005	0.688	0.875	0.625	0.375	0.032	0.375	UNP375-2750-625-H9J
	+0.003	3	-0.003	0.413	0.538	0.375	0.25	0.02	0.312	UNP250-3000-375-H9J
4	+0.005	3	-0.007	0.550	0.800	0.5	0.5	0.04	0.375	UNP500-3000-500-H9J
	+0.003	3.5	-0.003	0.413	0.538	0.375	0.25	0.02	0.312	UNP250-3500-375-H9J
4.5	+0.004	3.75	-0.005	0.688	0.875	0.625	0.375	0.032	0.375	UNP375-3750-625-H9J
5	+0.004	4.25	-0.005	0.550	0.738	0.5	0.375	0.032	0.375	UNP375-4250-500-H9J
	+0.003	4.5	-0.003	0.413	0.538	0.375	0.25	0.02	0.312	UNP250-4500-375-H9J

¹⁾ In case of higher pressures, SKF provides full-face anti-extrusion rings on request. For additional information, contact SKF.

2.12 UNP profile piston seals, inch sizes

D 5.5 – 6.5 in.

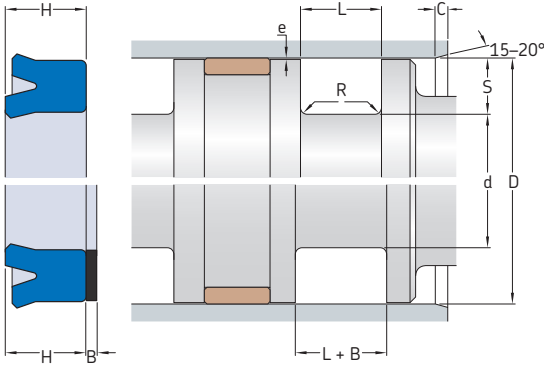

Maximum extrusion gap e

Radial depth e_{\max} at 80 °C (175 °F) for pressures
S 2 300 psi 3 600 psi 5 075 psi

in.	in.		
0.125	0.008	0.004	–
0.187	0.014	0.008	–
0.25	0.018	0.01	0.004
0.375	0.02	0.012	0.006
0.5	0.022	0.012	0.006

For additional information → page 34

With and without full-face anti-extrusion ring¹⁾

Dimensions

Designation

D	Tolerance	d	Tolerance	L	L+B	H	S	R	C	Designation
in.				+0.01	+0.01	nom.		max.	min.	
5.5	+0.004	4.75	-0.005	0.688	0.875	0.625	0.375	0.032	0.375	UNP375-4750-625-H9J
6	+0.004	5.25	-0.005	0.413	0.600	0.375	0.375	0.032	0.375	UNP375-5250-375-H9J
6.5	+0.004	5.75	-0.005	0.688	0.875	0.625	0.375	0.032	0.375	UNP375-5750-625-H9J

Other sizes are available on request

¹⁾ In case of higher pressures, SKF provides full-face anti-extrusion rings on request. For additional information, contact SKF.

Piston seals

More piston seals

The piston seals listed in this catalogue represent the preferred profiles in common sizes. SKF supplies many additional sizes and profiles. The following profiles are also manufactured in series production. SKF can provide customized sealing solutions also for the toughest application conditions. For additional information about these profiles or if the application requires a solution outside of what is provided in this catalogue, contact SKF.

More PTFE slide ring piston seals

Piston seals with PTFE slide rings are available in a wide variety of profiles and materials (→ **fig. 18**). For additional information about material options, contact SKF.

SPECTRASEAL

SPECTRASEAL is a PTFE seal that can be used as a single-acting piston seal (→ **fig. 19**). The metal spring energizer adds radial load to the seal lip contact areas. SPECTRASEAL is intended for extreme condition applications including high temperature or aggressive media. For additional information, contact SKF.

Customized machined seal profiles

SKF can manufacture a broad variety of piston seal profiles with different materials and sizes with its industry-leading SKF SEAL JET production system (→ **fig. 20**). For additional information about customized machined profiles, refer to publication *Customized machined seals – Product range* or contact SKF.

Fig. 18

PTFE slide ring piston seals, profile examples

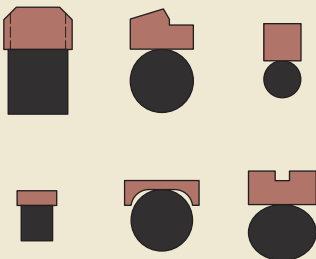

Fig. 19

SPECTRASEAL

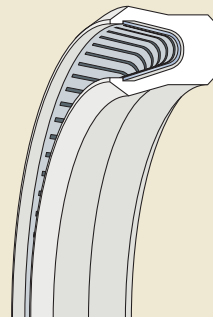

Fig. 20

SKF SEAL JET profile examples



K01-P



K01-PE



K01-R



K01-RE



K02-P



K02-PD



K02-R



K02-RD



K03-P



K03-F



K03-5



K04-P



K04-PD



K05-P



K05-R



K06-P



K06-R



K07-P

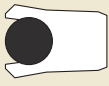

K07-F



K08-E



K08-D



K08-P



K08-ES



K08-D5



K09-N



K09-D



K09-H



K09-F

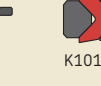

K1012-T



K1012-M



K1315-T



K16-A



K16-B



K17-P



K17-R

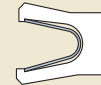

K19-F



K20-R



K21-P

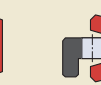

K22-P

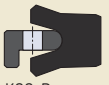

K22-R



K23-N



K23-D



K23-H



K23-F



K24-P



K32-P



K35-P



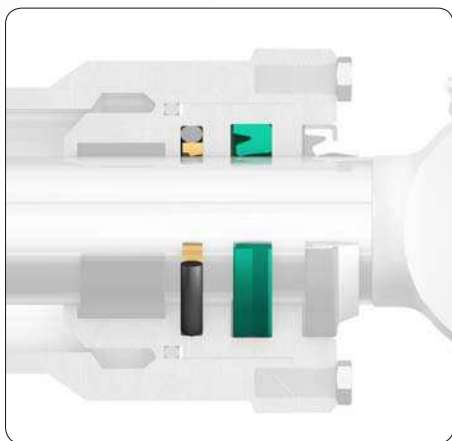
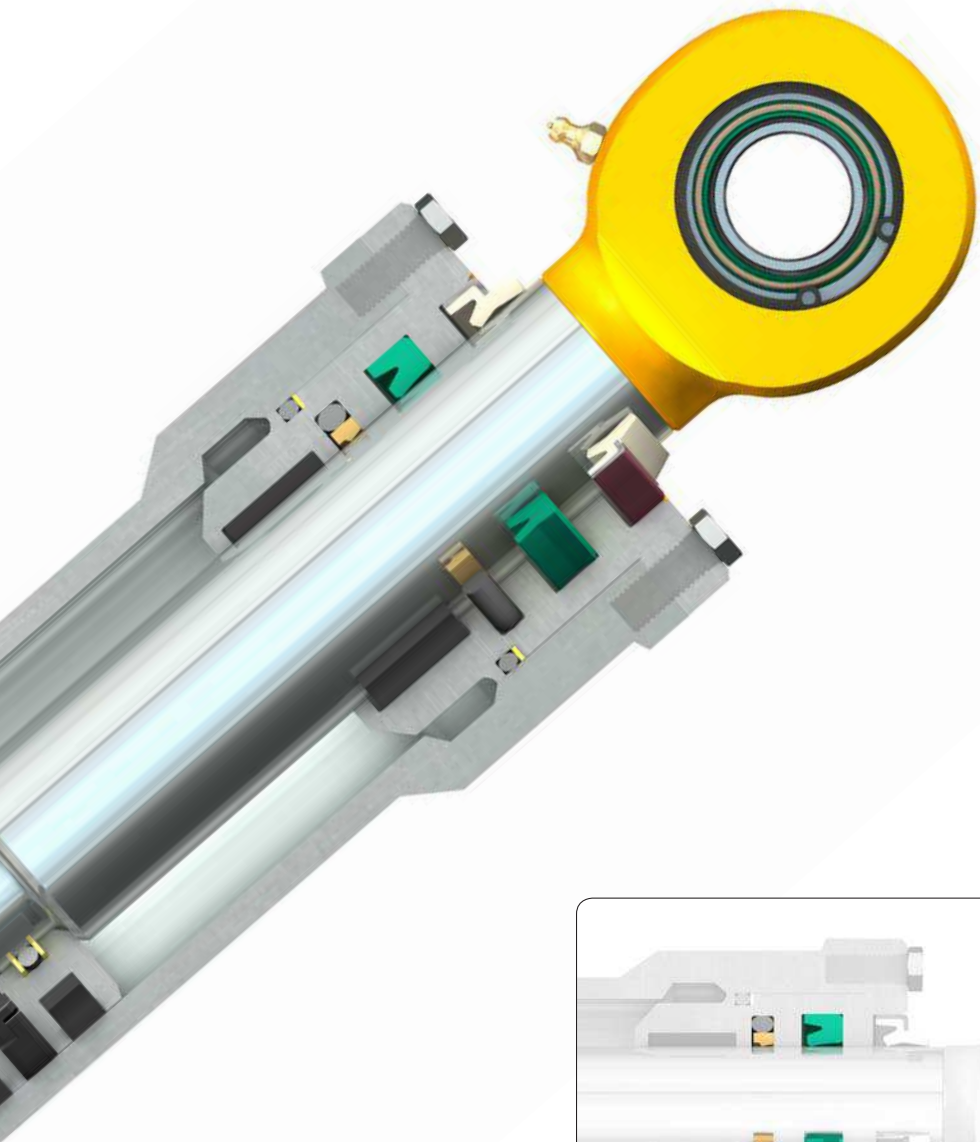



2





Rod and buffer seals

Profile overview	112	Profile data	
Basics	114	3.1 S1S	122
Rod sealing systems	114	Metric sizes	123
Materials	114	3.2 ZBR	126
Anti-extrusion rings	115	Metric sizes	127
Rod guidance	115	Inch sizes	131
Rod seals	116	3.3 SIL	134
Polyurethane U-cup rod seals	116	Metric sizes	135
S1S profiles	116	3.4 PTB	138
ZBR profiles	116	Metric sizes	139
SIL profiles	117	Inch sizes	149
Energized U-cup rod seals	117	3.5 STD	164
PTB profiles	117	Inch sizes	165
STD profiles	118	3.6 DZ	178
Hybrid rod seals	118	Metric sizes	179
DZ profiles	118	Inch sizes	180
DZR profiles	119	3.7 DZR	184
Buffer seals	120	Metric sizes	185
Polyurethane U-cup buffer seals	120	Inch sizes	186
RBB profiles	120	3.8 RBB	188
Buffer seals incorporating slide rings ..	120	Metric sizes	189
S9B profiles	120	Inch sizes	191
RSB profiles	121	3.9 S9B	192
		Metric sizes	193
		Inch sizes	196
		3.10 RSB	198
		Inch sizes	199
		More rod and buffer seals	202
		Rod locking T-seals	202
		TEFLATHANE seals	202
		Chevron V-packing sets	202
		SPECTRASEAL	203
		Customized machined seal profiles	204

Profile overview

Profile	Description	Additional information → page	Profile data → page
S1S 	Single-lip U-cup profile made of polyurethane; suitable for medium to heavy duty applications	116	122 (metric)
ZBR 	Double-lip U-cup profile made of polyurethane; suitable for medium to heavy duty applications	116	126 (metric and inch)
SIL 	Double-lip U-cup profile made of polyurethane; suitable for low temperatures and light to medium duty applications	117	134 (metric)
PTB 	Polyurethane U-cup profile with incorporated nitrile rubber X-ring, which provides good performance even at low pressure and temperature; suitable for medium duty applications	117	138 (metric and inch)
STD 	Polyurethane U-cup profile with incorporated nitrile rubber X-ring, which provides good performance even at low pressure and temperature; fits narrow housings; suitable for medium duty applications	118	164 (inch)
DZ 	Nitrile rubber primary sealing ring, polyurethane secondary sealing ring; low friction; suitable for medium to heavy duty applications	118	178 (metric and inch)
DZR 	Nitrile rubber primary sealing ring, polyurethane secondary sealing ring, integrated triangular polyamide anti-extrusion ring; improved gap extrusion resistance; suitable for heavy duty applications and extreme pressures	119	184 (metric and inch)

Profile	Description	Additional information → page	Profile data → page
RBB 	Buffer seal with polyurethane sealing ring, integrated polyacetal or polyamide anti-extrusion ring; designed to vent pressure back to system side; improved gap extrusion resistance at abrupt pressure peaks; fits narrow housings; suitable for heavy duty applications	120	188 (metric and inch)
S9B 	Buffer seal with nitrile rubber O-ring energizer, PTFE slide ring; also available with polyurethane slide ring to improve wear resistance and ease installation; suitable for medium to heavy duty applications	120	192 (metric and inch)
RSB 	Buffer seal with PTFE slide ring, nitrile rubber energizer; patented and improved design to reduce pressure peaks acting on the rod seal and vent pressure back to system side; improved gap extrusion resistance at abrupt pressure peaks; suitable for medium to heavy duty applications	121	198 (inch)

Basics

Rod sealing systems

Rod and buffer seals maintain sealing contact in sliding motion between the cylinder head and the piston rod. Depending on the application, a rod sealing system can consist of a rod seal and a buffer seal (→ **fig. 1**) or a rod seal only (→ **fig. 2**). Rod sealing systems for heavy duty applications typically consist of a combination of both seal types, whereas the buffer seal is arranged between the rod seal and the piston in the cylinder head. Rod seals determine the tolerance for the rod diameter d .

In addition to the sealing function, rod seals also provide a thin lubrication film on the piston rod that lubricates themselves and the wiper seals. The lubricant also inhibits corrosion of the piston rod surface. However, the lubrication film must be thin enough so that it returns to the cylinder during the return stroke.

Selecting profiles and materials for a rod sealing system is a complex task, considering all possible cylinder designs and application criteria. SKF supplies rod and buffer seals in many different profiles and in a wide range of materials, series and sizes, which make them appropriate for a wide variety of operating conditions and applications.

Materials

Depending on the profile and the required characteristics of its components, rod and

More information

Counter-surface finish properties	22
Materials	26
Hydraulic fluids	31
Gap extrusion	34
Storage	36
Installation and assembly	38

Fig. 1

Typical rod seal arrangement for heavy duty hydraulic applications

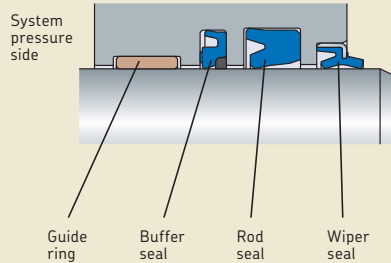
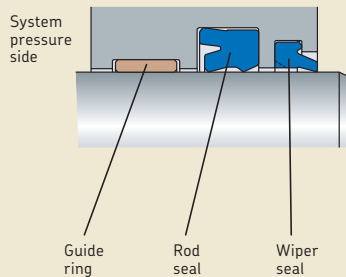

Fig. 2

Typical rod seal arrangement for light to medium duty hydraulic applications



buffer seals can consist of one or several materials. Common materials used for the sealing and energizing elements of rod and buffer seals are thermoplastic polyurethane (TPU), polytetrafluoroethylene (PTFE) or nitrile rubber (NBR). Common materials used for rod seal anti-extrusion rings are polyamide (PA), polyacetal (POM) or PTFE. The materials used for a specific profile are provided in the *Profile overview* (→ **page 112**) and in the relevant profile sections below.

For additional information, refer to *Materials* (→ **page 26**).

Fig. 3

Anti-extrusion rings

External forces acting on the rod can cause pressure peaks. They can be far in excess of the system operating pressure and may press a rod seal into the gap between the piston rod and the cylinder head. This risk of gap extrusion can be avoided for rod and buffer seals by using anti-extrusion rings. These hard and temperature-resistant rings can be integrated in the seal or a separate full-face anti-extrusion ring can be used. This ring can be added to a rod seal by simply extending the housing length (→ **fig. 3**). Integrated anti-extrusion rings fit into a notch in the rod or buffer seal and do not need an extended housing length.

DZR (→ **fig. 10, page 119**) profile rod seals and RBB (→ **fig. 11, page 120**) profile buffer seals incorporate an anti-extrusion ring. Other U-cup and energized U-cup rod seals with an integrated anti-extrusion ring are available on request. For seals without an integrated anti-extrusion ring, SKF provides full-face anti-extrusion rings on request. For additional information, contact SKF.

Integrated and full-face anti-extrusion rings

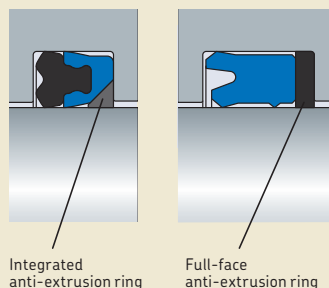

Rod guidance

Although rod sealing systems are designed to accommodate minor radial motion between the piston rod and cylinder head, effective rod guidance is important to ensure best rod seal performance. Guide rings accurately center the rod within the head, which reduces radial deflection and motion acting on the seals. Guide rings also accommodate the radial loads acting on the cylinder assembly and avoid direct metal-to-metal contact between the piston rod and cylinder head. For additional information about rod guidance, refer to *Guide rings and guide strips* (→ **page 249**).

Rod seals

Rod seals are typically single-acting seals, which means that fluid pressure acts from inside the cylinder on one seal side only. Pressures acting on the rod side of the piston can be in excess of 400 bar (5 800 psi), pressure peaks can be even higher. The pressure acting on the rod seal increases contact forces between the rod seal and rod surfaces. Therefore, rod seal materials should be wear resistant and the rod surface needs to be manufactured to the recommended specifications (→ *Counter-surface finish properties*, page 22).

Polyurethane U-cup rod seals

U-cup seals, as their name implies, have a U-shaped profile, including an outside static sealing lip and an inside dynamic sealing lip. The unique combination of resilience and its resistance to gap extrusion and wear makes thermoplastic polyurethane (TPU) the most common material used for U-cup seals in hydraulic applications.

They are available with a single- or double-lip design.

S1S profiles

S1S profiles (→ fig. 4) are made of ECOPUR (TPU) and have a single-lip design. The geometry has been optimized using FEA (Finite Element Analysis) to provide the longest possible maintenance-free service. They are suitable for pressures up to 400 bar (5 800 psi) in medium to heavy duty applications and are available in metric sizes. Some fit seal housings in accordance with ISO 5597.

ZBR profiles

ZBR profiles (→ fig. 5) are made of LUBRITHANE (TPU) and have a double-lip design. They are suitable for pressures up to 400 bar (5 800 psi) in medium to heavy duty applications and are available in metric and inch sizes. Some metric sizes fit seal housings in accordance with ISO 5597.

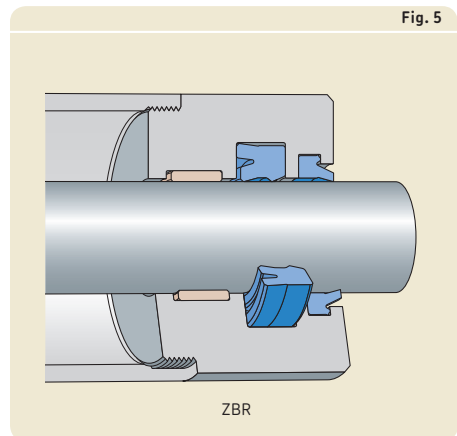
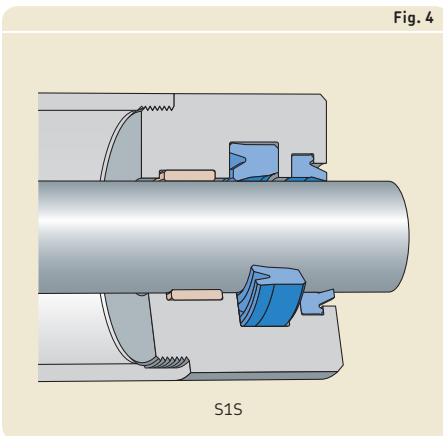

SIL profiles

SIL profiles (→ **fig. 6**) are made of ether-based TPU. They have a double-lip design and a secondary dynamic sealing lip. These seals provide good resistance to hydrolysis (attack from moisture) and good low temperature resilience. SIL profiles are suitable for pressures up to 350 bar (5 075 psi) in light to medium duty applications and are available in metric sizes. Some fit seal housings in accordance with ISO 5597.

Energized U-cup rod seals

Energized U-cup rod seals incorporate a nitrile rubber (NBR) X-ring in their thermoplastic polyurethane (TPU) U-cup. The X-ring serves as energizer, provides additional sealing force and improves the long-term resilience of the sealing lips. This can be beneficial in applications with low operating pressure or low temperatures.

PTB profiles

PTB profiles (→ **fig. 7**) are made of LUBRITHANE (TPU). They are suitable for pressures up to 400 bar (5 800 psi) in medium duty applications and are available in metric and inch sizes. Some metric sizes fit seal housings in accordance with ISO 5597.

Fig. 6

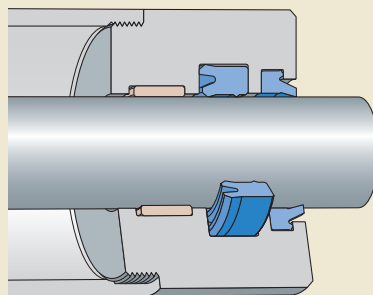

SIL

Fig. 7

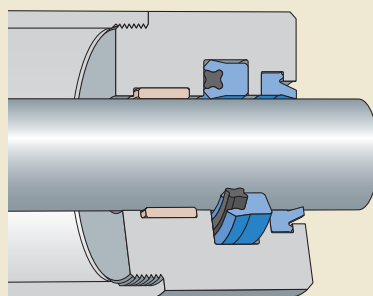

PTB

Rod and buffer seals

STD profiles

STD profiles (→ **fig. 8**) are made of LUBRITHANE (TPU). They are suitable for pressures up to 400 bar (5 800 psi) in medium duty applications and can also be used as a heavy duty static seal or a snap-in wiper seal. These profiles are available in inch sizes where narrower seal housings are used. Metric sizes are available on request.

Hybrid rod seals

Hybrid rod seals incorporate dynamic sealing lips of different materials. These material combinations provide a hybrid with the functional benefit of each material and, therefore, a robust rod seal. An example is the sealing ability and resilience of nitrile rubber (NBR) combined with the extrusion and wear resistance of polyurethane (TPU).

DZ profiles

DZ profiles (→ **fig. 9**) combine an NBR primary sealing ring with a LUBRITHANE (TPU) secondary sealing ring into one seal. This combination provides a good low temperature resilience and is suitable for pressures up to 400 bar (5 800 psi) in medium to heavy duty applications. DZ profiles are available in metric and inch sizes. They are also available with an elastomer (FLUOROTREL/TPC) secondary sealing ring on request.

These SKF hybrid rod seals have been proven successful in low temperature applications. The NBR primary lips also provide improved long term sealing performance and a greater capability to track larger radial deflections between the rod and the head.

Fig. 8

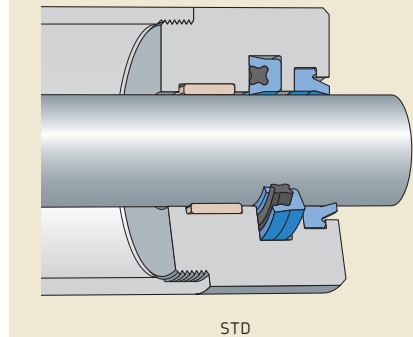

Fig. 9

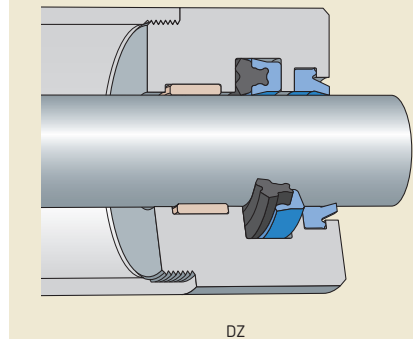
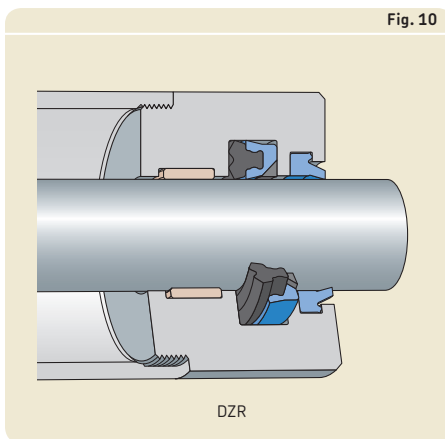

Fig. 10

DZR profiles

DZR profiles (→ **fig. 10**) combine an NBR primary sealing ring, a LUBRITHANE (TPU) secondary sealing ring and a triangular polyamide (PA) anti-extrusion ring (→ *Anti-extrusion rings*, **page 115**) into one seal. These combinations provide good low temperature resilience, and improved resistance to deformation, wear, and gap extrusion. They are suitable for extreme pressures up to 690 bar (*10 000 psi*) in heavy duty applications. DZR profiles are available in metric and inch sizes.



Buffer seals

Buffer seals protect the rod seals by reducing the magnitude of pressure peaks. Abrupt pressure peaks can occur by external forces acting on the piston rod, initiated by the fluid inside the cylinder. These pressure peaks can be far in excess of the system operating pressure. Buffer seals in combination with rod seals provide an effective rod sealing system for cylinders in heavy duty applications at high temperature and pressure.

Polyurethane U-cup buffer seals

RBB profiles

RBB profiles (→ **fig. 11**) have a LUBRITHANE (TPU) sealing ring that incorporates a polyamide (PA) or polyacetal (POM) anti-extrusion ring. The flexible outside static sealing lip and notches in the front face ensure that pressure can return to the system side of the buffer and prevent build-up of pressure between the rod and buffer seals. These profiles are suitable for extreme pressure peaks and demanding workloads in heavy duty applications up to 690 bar (10 000 psi). They are available in metric and inch sizes, some metric sizes fit seal housings in accordance with ISO 7425-2.

Buffer seals incorporating slide rings

S9B profiles

S9B profiles (→ **fig. 12**) have a nitrile rubber (NBR) O-ring energizer and a PTFE slide ring as standard. Depending on the application, SKF can manufacture the slide rings from a variety of PTFE materials. On request, SKF can supply these profiles also with X-ECOPUR polyurethane (TPU) slide rings for improved wear resistance and ease of installation compared to PTFE. S9B profiles with a PTFE slide ring are suitable for pressures up to 400 bar (5 800 psi), those with an X-ECOPUR slide ring up to 600 bar (8 700 psi). These profiles are suitable for medium to heavy duty applications. Both material combinations are available in metric and inch sizes, some metric sizes fit seal housings in accordance with ISO 7425-2 or ISO 3320.

Fig. 11

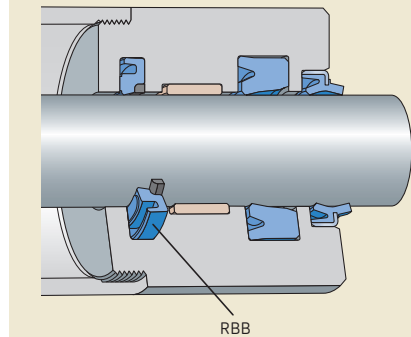
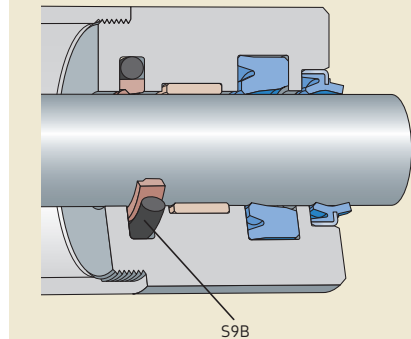

Fig. 12



RSB profiles

RSB profiles (→ **fig. 13**) have a nitrile rubber (NBR) energizer and a PTFE slide ring.

The energizer is designed to hold the slide ring in the proper and permanent sealing position against the rod seal side of the housing. Conventional buffer seal designs can shift axially within the groove and push fluid into the rod seal groove when subjected to abrupt pressure peaks. This ultimately causes rod seal failure. However, the patented design of RSB profiles prevents any axial shifting of the slide ring. Therefore, these profiles protect the rod seal in applications where conventional buffers are not sufficient. In combination with grooves in the energizer outside diameter and notches in the front face of the slide ring (→ **fig. 14**), the protrusions also ensure that pressure can return to the system side.

RSB profiles are suitable for pressures up to 400 bar (5 800 psi) in medium to heavy duty applications and are available in inch sizes.

On request, for the most demanding applications of large equipment, SKF can manufacture these profiles with polyamide (PA) slide rings for additional extrusion and wear resistance.

Fig. 13

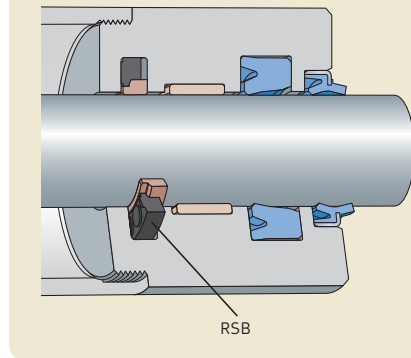
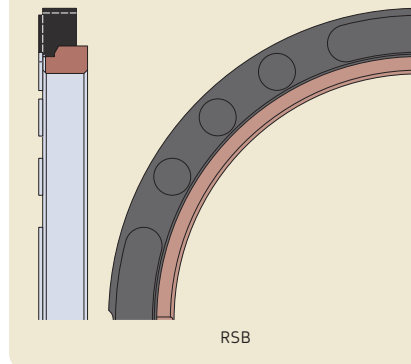

Fig. 14



S1S profile data



Material code	ECOPUR For additional information → page 26												
Pressure	Up to 400 bar (5 800 psi)												
Speed	Up to 1 m/s (3.2 ft/s)												
Temperature range	<div style="display: flex; align-items: center;"> <table style="margin-left: 20px; border-collapse: collapse;"> <tr> <td style="text-align: right;">-60</td> <td style="text-align: center;">-40</td> <td style="text-align: center;">-30</td> <td style="text-align: right;">110</td> <td style="text-align: center;">120</td> <td style="text-align: left;">130 [°C]</td> </tr> <tr> <td style="text-align: right;">-75</td> <td style="text-align: center;">-40</td> <td style="text-align: center;">-20</td> <td style="text-align: right;">230</td> <td style="text-align: center;">250</td> <td style="text-align: left;">265 [°F]</td> </tr> </table> </div> <ul style="list-style-type: none"> Extreme low temperature range: may be intermittently exposed (e.g. cold start-up) without seal damage, but seal performance may be compromised while in this range Temperatures below the recommended operating range: seal performance depends on system design (precision guiding arrangement recommended) Recommended operating temperature range for this profile and material Temperatures above the recommended operating range: acceptable only with reduced pressure, speed, e-gap and/or with the use of a full-face anti-extrusion ring Extreme high temperature range: only occasional short-term exposure (e.g. cylinder in curing oven of a powder coating process) 	-60	-40	-30	110	120	130 [°C]	-75	-40	-20	230	250	265 [°F]
-60	-40	-30	110	120	130 [°C]								
-75	-40	-20	230	250	265 [°F]								
Dimension standards	Some sizes fit seal housings in accordance with ISO 5597.												
Counter-surface	→ page 22												

Maximum values of application parameters (e.g. pressure, speed, temperature, e-gap) should not be applied continuously nor simultaneously.

3.1 S1S profile rod seals, metric sizes d 18 – 110 mm

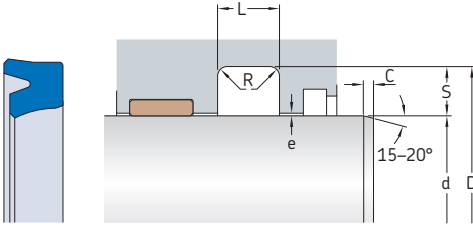

Maximum extrusion gap e

Radial depth S	e _{max} at 80 °C (175 °F) for pressures		
	160 bar	250 bar	400 bar
mm	mm		
4	0,4	0,3	0,15
5	0,5	0,4	0,2
7,5	0,55	0,45	0,25
10	0,6	0,5	0,3

For additional information → page 34

Dimensions

d f8 or h9	D H10	L +0,2	S	R max.	C min.
---------------	----------	-----------	---	-----------	-----------

mm

Designation

18	26	6,3	4	0,4	3,5	• S1S-18x26x6.3
20	28	6,3	4	0,4	3,5	S1S-20x28x6.3
25	33	6	4	0,4	3,5	S1S-25x33x6
	35	8	5	0,4	4	• S1S-25x35x8
28	38	8	5	0,4	4	• S1S-28x38x8
30	40	7	5	0,4	4	S1S-30x40x7
32	42	8	5	0,4	4	• S1S-32x42x8
35	45	7	5	0,4	4	S1S-35x45x7
36	46	8	5	0,4	4	• S1S-36x46x8
40	50	8	5	0,4	4	• S1S-40x50x8
45	55	8	5	0,4	4	• S1S-45x55x8
50	60	8	5	0,4	4	S1S-50x60x8
	65	10	7,5	0,4	5	• S1S-50x65x10
55	65	10	5	0,4	4	S1S-55x65x10
	70	10	7,5	0,4	5	S1S-55x70x10
63	78	10	7,5	0,4	5	• S1S-63x78x10
75	85	12,4	5	0,4	4	S1S-75x85x12.4
80	95	10	7,5	0,4	5	• S1S-80x95x10
	95	12,4	7,5	0,4	5	S1S-80x95x12.4
90	105	10	7,5	0,4	5	• S1S-90x105x10
100	115	10	7,5	0,4	5	• S1S-100x115x10
110	125	10	7,5	0,4	5	• S1S-110x125x10

• Dimensions in accordance with ISO 5597

3.1 S1S profile rod seals, metric sizes d 125 – 240 mm

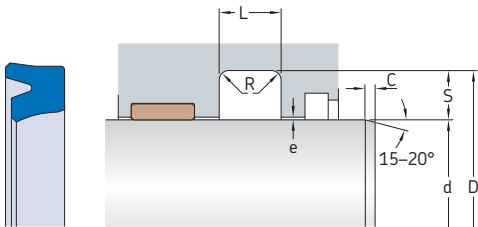

Maximum extrusion gap e

Radial depth S	e _{max} at 80 °C (175 °F) for pressures		
	160 bar	250 bar	400 bar
mm	mm		
4	0,4	0,3	0,15
5	0,5	0,4	0,2
7,5	0,55	0,45	0,25
10	0,6	0,5	0,3

For additional information → [page 34](#)

Dimensions						Designation
d f8 or h9	D H10	L +0,2	S	R max.	C min.	
mm						-
125	145	16	10	0,4	6	S1S-125x145x16
140	155	10	7,5	0,4	5	• S1S-140x155x10
160	180	16	10	0,4	6	S1S-160x180x16
180	200	14	10	0,4	6	• S1S-180x200x14
200	220	14	10	0,4	6	• S1S-200x220x14
240	260	16	10	0,4	6	S1S-240x260x16

Other sizes are available on request

• Dimensions in accordance with ISO 5597

ZBR profile data



Material code	U-1029 For additional information → page 26												
Pressure	Up to 400 bar (5 800 psi)												
Speed	Up to 1 m/s (3.2 ft/s)												
Temperature range	<div style="display: flex; align-items: center;"> <table style="margin-left: 10px;"> <tr> <td>-60</td> <td>-40</td> <td>-30</td> <td>110</td> <td>120</td> <td>130 [°C]</td> </tr> <tr> <td>-75</td> <td>-40</td> <td>-20</td> <td>230</td> <td>250</td> <td>265 [°F]</td> </tr> </table> </div> <ul style="list-style-type: none"> ■ Extreme low temperature range: may be intermittently exposed (e.g. cold start-up) without seal damage, but seal performance may be compromised while in this range ■ Temperatures below the recommended operating range: seal performance depends on system design (precision guiding arrangement recommended) ■ Recommended operating temperature range for this profile and material ■ Temperatures above the recommended operating range: acceptable only with reduced pressure, speed, e-gap and/or with the use of a full-face anti-extrusion ring ■ Extreme high temperature range: only occasional short-term exposure (e.g. cylinder in curing oven of a powder coating process) 	-60	-40	-30	110	120	130 [°C]	-75	-40	-20	230	250	265 [°F]
-60	-40	-30	110	120	130 [°C]								
-75	-40	-20	230	250	265 [°F]								
Dimension standards	Some metric sizes fit seal housings in accordance with ISO 5597.												
Counter-surface	→ page 22												

Maximum values of application parameters (e.g. pressure, speed, temperature, e-gap) should not be applied continuously nor simultaneously.

3.2 ZBR profile rod seals, metric sizes d 14 – 45 mm

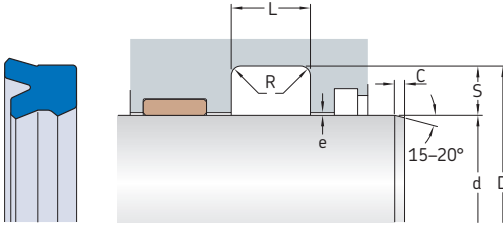

Maximum extrusion gap e

Radial depth S	e _{max} at 80 °C (175 °F) for pressures		
	160 bar	250 bar	400 bar
mm	mm		
3,5 to 4	0,35	0,2	–
5 to 6,5	0,45	0,25	0,1
7 to 7,5	0,5	0,3	0,15
10	0,55	0,3	0,15
12,5	0,6	0,3	0,2

For additional information → page 34

Dimensions

d f8 or h9	D H10	L +0,2	S	R max.	C min.
---------------	----------	-----------	---	-----------	-----------

mm

Designation

–

14	22	5,7	4	0,2	6	ZBR-14x22x5.7-E6W
16	24	5,7	4	0,2	6	ZBR-16x24x5.7-E6W
18	26	5,7	4	0,2	6	ZBR-18x26x5.7-E6W
20	28	5,7	4	0,2	6	ZBR-20x28x5.7-E6W
22	30	5,7	4	0,2	6	ZBR-22x30x5.7-E6W
22,4	30	5,7	3,8	0,2	6	ZBR-22.4x30x5.7-E6W
25	33	5,7	4	0,2	6	ZBR-25x33x5.7-E6W
	33	8	4	0,2	6	ZBR-25x33x8-E6W
28	35	5,7	3,5	0,2	6	ZBR-28x35.5x5.7-E6W
	36	6,4	4	0,2	6	ZBR-28x36x6.4-E6W
30	38	7,8	4	0,2	6	ZBR-30x38x7.8-E6W
	40	7	5	0,2	6	ZBR-30x40x7-E6W
32	40	6,4	4	0,2	6	ZBR-32x40x6.4-E6W
	42	8,3	5	0,2	6	ZBR-32x42x8.3-E6W
35	43	7,8	4	0,2	6	ZBR-35x43x7.8-E6W
	45	7	5	0,2	6	ZBR-35x45x7-E6W
	45	11	5	0,2	6	ZBR-35x45x11-E6W
40	50	7	5	0,2	6	ZBR-40x50x7-E6W
	50	7	5	0,2	6	ZBR-40x50x7-E6W
	50	11	5	0,2	6	ZBR-40x50x11-E6W
	55	11	7,5	0,5	8,5	ZBR-40x55x11-E6W
	55	12	7,5	0,5	8,5	ZBR-40x55x12-E6W
45	55	7	5	0,2	6	ZBR-45x55x7-E6W
	55	8,3	5	0,2	6	ZBR-45x55x8.3-E6W
	55	11	5	0,2	6	ZBR-45x55x11-E6W
	60	11	7,5	0,5	8,5	ZBR-45x60x11-E6W
	60	12	7,5	0,5	8,5	ZBR-45x60x12-E6W
	60	12,5	7,5	0,2	8,5	• ZBR-45x60x12.5-E6W

• Dimensions in accordance with ISO 5597

3.2 ZBR profile rod seals, metric sizes d 50 – 150 mm

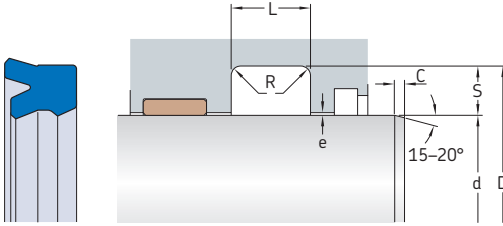

Maximum extrusion gap e

Radial depth S	e _{max} at 80 °C (175 °F) for pressures		
	160 bar	250 bar	400 bar
mm	mm		
3,5 to 4	0,35	0,2	–
5 to 6,5	0,45	0,25	0,1
7 to 7,5	0,5	0,3	0,15
10	0,55	0,3	0,15
12,5	0,6	0,3	0,2

For additional information → page 34

Dimensions

Designation

d f8 or h9	D H10	L +0,2	S	R max.	C min.	
mm						–
50	60	7	5	0,2	6	ZBR-50x60x7-E6W
	60	8,3	5	0,2	6	ZBR-50x60x8.3-E6W
	60	8,5	5	0,2	6	ZBR-50x60x8.5-E6W
	65	11	7,5	0,5	8,5	ZBR-50x65x11-E6W
	65	12,4	7,5	0,5	8,5	ZBR-50x65x12.4-E6W
53	63	7	5	0,2	6	ZBR-53x63x7-E6W
55	65	7	5	0,2	6	ZBR-55x65x7-E6W
	65	9	5	0,2	6	ZBR-55x65x9-E6W
	65	11	5	0,2	6	ZBR-55x65x11-E6W
	68	11	6,5	0,2	7,5	ZBR-55x68x11-E6W
	70	10	7,5	0,5	8,5	ZBR-55x70x10-E6W
	70	11	7,5	0,5	8,5	ZBR-55x70x11-E6W
	70	12,4	7,5	0,2	8,5	ZBR-55x70x12.4-E6W
	75	13	10	0,8	6	ZBR-55x75x13-E6W
56	71	12,4	7,5	0,5	8,5	• ZBR-56x71x12.4-E6W
60	68	9	4	0,2	6	ZBR-60x68x9-E6W
	70	7	5	0,2	6	ZBR-60x70x7-E6W
	70	11	5	0,2	6	ZBR-60x70x11-E6W
	73	11	6,5	0,2	7,5	ZBR-60x73x11-E6W
	75	10	7,5	0,5	8,5	ZBR-60x75x10-E6W
	80	13	10	0,8	11	ZBR-60x80x13-E6W
63	73	7	5	0,2	6	ZBR-63x73x7-E6W
	78	12,4	7,5	0,5	8,5	ZBR-63x78x12.4-E6W
	78	13,5	7,5	0,5	6	ZBR-63x78x13.5-E6W
65	75	7	5	0,2	6	ZBR-65x75x7-E6W
	78	11	6,5	0,2	7,5	ZBR-65x78x11-E6W
	80	10	7,5	0,5	8,5	ZBR-65x80x10-E6W
	80	13	7,5	0,5	8,5	ZBR-65x80x13-E6W
	85	13	10	0,8	11	ZBR-65x85x13-E6W

• Dimensions in accordance with ISO 5597

Dimensions						Designation
d f8 or h9	D H10	L +0,2	S	R max.	C min.	
mm						-
70	80	7	5	0,2	6	ZBR-70x80x7-E6W
	83	11	6,5	0,2	7,5	ZBR-70x83x11-E6W
	85	10	7,5	0,5	8,5	ZBR-70x85x10-E6W
	85	11	7,5	0,5	8,5	ZBR-70x85x11-E6W
	85	12,4	7,5	0,5	8,5	• ZBR-70x85x12.4-E6W
	90	13	10	0,8	11	ZBR-70x90x13-E6W
75	85	7	5	0,2	6	ZBR-75x85x7-E6W
	88	11	6,5	0,2	7,5	ZBR-75x88x11-E6W
	90	10	7,5	0,5	8,5	ZBR-75x90x10-E6W
	90	11	7,5	0,5	8,5	ZBR-75x90x11-E6W
	95	13	10	0,8	11	ZBR-75x95x13-E6W
80	90	7	5	0,2	6	ZBR-80x90x7-E6W
	93	11	6,5	0,2	7,5	ZBR-80x93x11-E6W
	95	10	7,5	0,5	8,5	ZBR-80x95x10-E6W
	95	12,4	7,5	0,5	8,5	• ZBR-80x95x12.4-E6W
	100	13	10	0,8	11	ZBR-80x100x13-E6W
85	100	10	7,5	0,5	8,5	ZBR-85x100x10-E6W
	100	11	7,5	0,5	8,5	ZBR-85x100x11-E6W
	100	13	7,5	0,5	8,5	ZBR-85x100x13-E6W
	105	13	10	0,8	11	ZBR-85x105x13-E6W
90	105	11	7,5	0,5	8,5	ZBR-90x105x11-E6W
	105	12,4	7,5	0,5	8,5	• ZBR-90x105x12.4-E6W
	110	13	10	0,8	11	ZBR-90x110x13-E6W
95	110	10	7,5	0,5	8,5	ZBR-95x110x10-E6W
	110	11	7,5	0,5	8,5	ZBR-95x110x11-E6W
	115	13	10	0,8	11	ZBR-95x115x13-E6W
100	112	15	6	0,2	7	ZBR-100x112x15-E6W
	115	10	7,5	0,5	8,5	ZBR-100x115x10-E6W
	115	11	7,5	0,5	8,5	ZBR-100x115x11-E6W
	115	12,5	7,5	0,5	8,5	ZBR-100x115x12.5-E6W
	120	13	10	0,8	11	ZBR-100x120x13-E6W
	120	15,5	10	0,8	11	ZBR-100x120x15.5-E6W
105	120	10	7,5	0,5	8,5	ZBR-105x120x10-E6W
	125	16,5	10	0,8	11	ZBR-105x125x16.5-E6W
110	125	11	7,5	0,5	8,5	ZBR-110x125x11-E6W
	130	16,5	10	0,8	11	ZBR-110x130x16.5-E6W
112	125	10	6,5	0,2	7,5	ZBR-112x125x10-E6W
118	133	10	7,5	0,5	8,5	ZBR-118x133x10-E6W
120	140	16,5	10	0,8	11	ZBR-120x140x16.5-E6W
125	140	10	7,5	0,5	8,5	ZBR-125x140x10-E6W
	145	16,5	10	0,8	11	ZBR-125x145x16.5-E6W
130	145	12	7,5	0,5	8,5	ZBR-130x145x12-E6W
	150	16,5	10	0,2	11	ZBR-130x150x16.5-E6W
136	150	10	7	0,5	8,5	ZBR-136x150x10-E6W
140	155	10	7,5	0,5	8,5	ZBR-140x155x10-E6W
	160	16,5	10	0,8	11	ZBR-140x160x16.5-E6W
145	160	10	7,5	0,5	8,5	ZBR-145x160x10-E6W
150	170	16,5	10	0,8	11	ZBR-150x170x16.5-E6W

• Dimensions in accordance with ISO 5597

3.2 ZBR profile rod seals, metric sizes d 160 – 255 mm

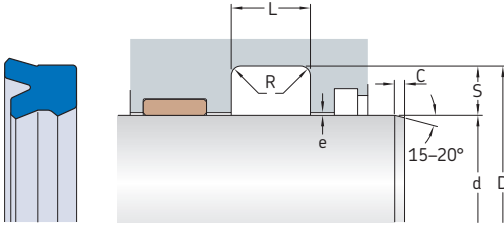

Maximum extrusion gap e

Radial depth S	e _{max} at 80 °C (175 °F) for pressures		
	160 bar	250 bar	350 bar
mm	mm		
3,5 to 4	0,35	0,2	–
5 to 6,5	0,45	0,25	0,1
7 to 7,5	0,5	0,3	0,15
10	0,55	0,3	0,15
12,5	0,6	0,3	0,2

For additional information → page 34

Dimensions

d f8 or h9	D H10	L +0,2	S	R max.	C min.
---------------	----------	-----------	---	-----------	-----------

mm

Designation

–

160	180 185	16,5 19,7	10 12,5	0,8 0,8	11 13	ZBR-160x180x16.5-E6W ZBR-160x185x19.7-E6W
180	200	13,5	10	0,8	11	ZBR-180x200x13.5-E6W
200	220	13,5	10	0,8	11	ZBR-200x220x13.5-E6W
230	250	13,5	10	0,8	11	ZBR-230x250x13.5-E6W
240	260	16,5	10	0,8	11	ZBR-240x260x16.5-E6W
255	280	20,5	12,5	0,8	13	ZBR-255x280x20.5-E6W

Other sizes are available on request

3.2 ZBR profile rod seals, inch sizes d 0.75 – 3 in.

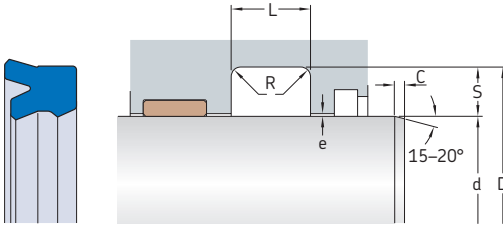

Maximum extrusion gap e

Radial depth S	e_{\max} at 80 °C (175 °F) for pressures		
	2 300 psi	3 600 psi	5 800 psi
in.	in.		
0.125	0.008	0.004	–
0.187	0.014	0.008	–
0.250	0.018	0.01	0.004
0.312	0.020	0.012	0.006
0.375	0.020	0.012	0.006
0.5	0.024	0.012	0.008

For additional information → page 34

Dimensions

d	Tolerance	D	Tolerance	L +0.010	S	R max.	C min.	Designation
in.								–
0.75	–0.001	1	+0.002	0.275	0.125	0.015	0.25	ZBR125-750-250-E6W
1	–0.001	1.25	+0.002	0.275	0.125	0.015	0.25	ZBR125-1000-250-E6W
1.125	–0.001	1.375	+0.002	0.213	0.125	0.015	0.25	ZBR125-1125-187-E6W
	–0.001	1.375	+0.002	0.275	0.125	0.015	0.25	ZBR125-1125-250-E6W
–0.002	1.5	+0.002	0.343	0.187	0.015	0.25	ZBR187-1125-312-E6W	
	1.25	–0.001	1.5	+0.002	0.213	0.125	0.015	0.25
–0.001	1.5	+0.002	0.223	0.125	0.015	0.25	ZBR125-1250-197-E6W	
	–0.001	1.5	+0.002	0.275	0.125	0.015	0.25	ZBR125-1250-250-E6W
–0.002	1.625	+0.002	0.275	0.187	0.015	0.25	ZBR187-1250-250-E6W	
	1.625	+0.002	0.343	0.187	0.015	0.25	ZBR187-1250-312-E6W	
1.375	–0.001	1.625	+0.002	0.275	0.125	0.015	0.25	ZBR125-1375-250-E6W
1.5	–0.001	1.75	+0.002	0.275	0.125	0.015	0.25	ZBR125-1500-250-E6W
	–0.002	1.875	+0.002	0.343	0.187	0.015	0.25	ZBR187-1500-312-E6W
–0.002	1.875	+0.002	0.413	0.187	0.015	0.25	ZBR187-1500-375-E6W	
	2	+0.003	0.413	0.250	0.02	0.312	ZBR250-1500-375-E6W	
1.75	–0.002	2.125	+0.002	0.343	0.187	0.015	0.25	ZBR187-1750-312-E6W
	–0.002	2.125	+0.002	0.413	0.187	0.015	0.25	ZBR187-1750-375-E6W
–0.002	2.25	+0.003	0.413	0.250	0.02	0.312	ZBR250-1750-375-E6W	
1.875	–0.002	2.375	+0.003	0.413	0.250	0.02	0.312	ZBR250-1875-375-E6W
2	–0.002	2.375	+0.002	0.343	0.187	0.015	0.25	ZBR187-2000-312-E6W
	–0.002	2.375	+0.002	0.413	0.187	0.015	0.25	ZBR187-2000-375-E6W
–0.002	2.5	+0.003	0.413	0.250	0.02	0.312	ZBR250-2000-375-E6W	
2.25	–0.002	2.625	+0.002	0.3685	0.187	0.015	0.25	ZBR187-2250-335-E6W
	–0.002	2.75	+0.003	0.413	0.250	0.02	0.312	ZBR250-2250-375-E6W
2.5	–0.002	3	+0.003	0.413	0.250	0.02	0.312	ZBR250-2500-375-E6W
2.625	–0.002	3.125	+0.003	0.413	0.250	0.02	0.312	ZBR250-2625-375-E6W
2.875	–0.002	3.375	+0.003	0.413	0.250	0.02	0.312	ZBR250-2875-375-E6W
3	–0.002	3.5	+0.003	0.413	0.250	0.02	0.312	ZBR250-3000-375-E6W



3.2 ZBR profile rod seals, inch sizes d 3.25 – 8 in.

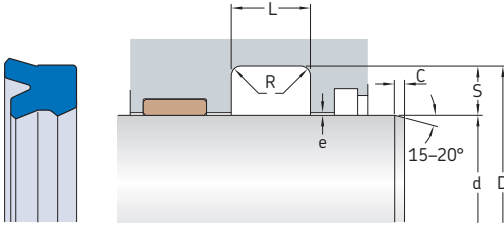

Maximum extrusion gap e

Radial depth S	e _{max} at 80 °C (175 °F) for pressures		
	2 300 psi	3 600 psi	5 800 psi
in.	in.		
0.125	0.008	0.004	–
0.187	0.014	0.008	–
0.250	0.018	0.01	0.004
0.312	0.02	0.012	0.006
0.375	0.02	0.012	0.006
0.5	0.024	0.012	0.008

For additional information → page 34

Dimensions

Designation

d	Tolerance	D	Tolerance	L +0.010	S	R max.	C min.	Designation
in.								–
3.25	–0.002	3.75	+0.003	0.413	0.250	0.02	0.312	ZBR250-3250-375-E6W
3.5	–0.002	4	+0.003	0.413	0.250	0.02	0.312	ZBR250-3500-375-E6W
3.75	–0.002	4.375	+0.004	0.55	0.312	0.02	0.375	ZBR312-3750-500-E6W
4	–0.002	4.5	+0.003	0.413	0.250	0.02	0.312	ZBR250-4000-375-E6W
4.75	–0.002	5.25	+0.003	0.688	0.250	0.02	0.312	ZBR250-4750-625-E6W
5	–0.002	5.5	+0.003	0.413	0.250	0.02	0.312	ZBR250-5000-375-E6W
	–0.002	5.5	+0.003	0.618	0.250	0.02	0.312	ZBR250-5000-562-E6W
5.25	–0.002	5.75	+0.003	0.618	0.250	0.02	0.312	ZBR250-5250-562-E6W
5.5	–0.002	6	+0.003	0.618	0.250	0.02	0.312	ZBR250-5500-562-E6W
	–0.002	6.25	+0.005	0.688	0.375	0.035	0.5	ZBR375-5500-625-E6W
6.5	–0.002	7.25	+0.005	0.688	0.375	0.035	0.5	ZBR375-6500-625-E6W
	–0.003	7.5	+0.007	0.825	0.500	0.035	0.625	ZBR500-6500-750E6W
7	–0.003	8	+0.007	0.825	0.500	0.035	0.625	ZBR500-7000-750E6W
7.75	–0.002	8.5	+0.005	0.688	0.375	0.035	0.5	ZBR375-7750-625-E6W
8	–0.002	8.75	+0.005	0.688	0.375	0.035	0.5	ZBR375-8000-625-E6W

Other sizes are available on request

SIL profile data



Material code	B93 For additional information → page 26
Pressure	Up to 350 bar (5 075 psi)
Speed	Up to 0,5 m/s (1.6 ft/s)
Temperature range	<div style="display: flex; align-items: center;"> </div> <p> ■ Extreme low temperature range: may be intermittently exposed (e.g. cold start-up) without seal damage, but seal performance may be compromised while in this range </p> <p> ■ Temperatures below the recommended operating range: seal performance depends on system design (precision guiding arrangement recommended) </p> <p> ■ Recommended operating temperature range for this profile and material </p> <p> ■ Extreme high temperature range: only occasional short-term exposure (e.g. cylinder in curing oven of a powder coating process) </p>
Dimension standards	Some sizes fit seal grooves in accordance with ISO 5597.
Counter-surface	→ page 22

Maximum values of application parameters (e.g. pressure, speed, temperature, e-gap) should not be applied continuously nor simultaneously.

3.3 SIL profile rod seals, metric sizes

d 10 – 30 mm

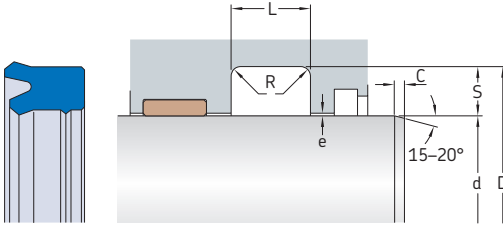

Maximum extrusion gap e

Radial depth S	e _{max} at 60 °C (140 °F) for pressures		
	160 bar	250 bar	350 bar
mm	mm		
3	0,2	0,1	–
4	0,35	0,2	–
5	0,45	0,25	0,1
7,5	0,5	0,3	0,15
10	0,55	0,3	0,15

For additional information → page 34

Dimensions

d f8 or h9 D H10 L +0,2 S R max. C min.

mm

Designation

–

10	18	6,3	4	0,3	2	• SIL 10x18x6.3
12	20	6,3	4	0,3	2	• SIL 12x20x6.3
	22	8	5	0,3	2,5	• SIL 12x22x8
14	22	6,3	4	0,3	2	• SIL 14x22x6.3
	24	8	5	0,3	2,5	• SIL 14x24x8
16	22	6	3	0,3	2	SIL 16x22x6
	24	6,3	4	0,3	2	• SIL 16x24x6.3
	24	7	4	0,3	2	SIL 16x24x7
18	24	5,2	3	0,3	2	SIL 18x24x5.2
	26	6,3	4	0,3	2	• SIL 18x26x6.3
20	26	5,5	3	0,3	2	SIL 20x26x5.5
	28	6,3	4	0,3	2	• SIL 20x28x6.3
	30	8	5	0,3	2,5	• SIL 20x30x8
	30	9	5	0,3	2,5	SIL 20x30x9
22	30	6,3	4	0,3	2	• SIL 22x30x6.3
	32	8	5	0,3	2,5	• SIL 22x32x8
25	33	6,3	4	0,3	2	• SIL 25x33x6.3
	33	7	4	0,3	2	SIL 25x33x7
	33	11	4	0,3	2	SIL 25x33x11
	35	8	5	0,3	2,5	• SIL 25x35x8
	35	9	5	0,3	2,5	SIL 25x35x9
	35	11	5	0,3	2,5	SIL 25x35x11
28	38	8	5	0,3	2,5	• SIL 28x38x8
	38	9	5	0,3	2,5	SIL 28x38x9
	43	12,5	7,5	0,4	4	• SIL 28x43x12.5
30	38	6,3	4	0,3	2	SIL 30x38x6.3
	40	8	5	0,3	2,5	SIL 30x40x8
	40	11	5	0,3	2,5	SIL 30x40x11
	45	11	7,5	0,4	4	SIL 30x45x11

• Dimensions in accordance with ISO 5597

3.3 SIL profile rod seals, metric sizes d 32 – 150 mm

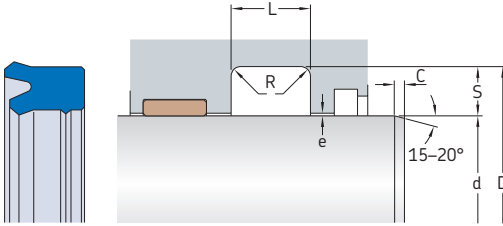

Maximum extrusion gap e

Radial depth S	e _{max} at 60 °C (140 °F) for pressures		
	160 bar	250 bar	350 bar
mm	mm		
3	0,2	0,1	–
4	0,35	0,2	–
5	0,45	0,25	0,1
7,5	0,5	0,3	0,15
10	0,55	0,3	0,15

For additional information → page 34

Dimensions

Designation

d f8 or h9	D H10	L +0,2	S	R max.	C min.	Designation
mm						–
32	40	6,3	4	0,3	2	SIL 32x40x6.3
	40	9	4	0,3	2	SIL 32x40x9
	42	8	5	0,3	2,5	• SIL 32x42x8
	42	11	5	0,3	2,5	SIL 32x42x11
	47	12,5	7,5	0,4	4	• SIL 32x47x12.5
33	43	11	5	0,3	2,5	SIL 33x43x11
35	43	6,3	4	0,3	2	SIL 35x43x6.3
	45	8	5	0,3	2,5	SIL 35x45x8
	45	11	5	0,3	2,5	SIL 35x45x11
	50	11	7,5	0,4	4	SIL 35x50x11
36	46	8	5	0,3	2,5	• SIL 36x46x8
	51	12,5	7,5	0,4	4	• SIL 36x51x12.5
40	50	8	5	0,3	2,5	• SIL 40x50x8
	50	11	5	0,3	2,5	SIL 40x50x11
	55	11	7,5	0,4	4	SIL 40x55x11
	55	12,5	7,5	0,4	4	• SIL 40x55x12.5
	60	13	5	0,6	5	SIL 40x60x13
42	52	11	5	0,3	2,5	SIL 42x52x11
45	55	8	5	0,3	2,5	• SIL 45x55x8
	55	11	5	0,3	2,5	SIL 45x55x11
	60	11	7,5	0,4	4	SIL 45x60x11
	60	12,5	7,5	0,4	4	• SIL 45x60x12.5
46	56	11	5	0,3	2,5	SIL 46x56x11
50	60	8	5	0,3	2,5	• SIL 50x60x8
	60	11	5	0,3	2,5	SIL 50x60x11
	65	11	7,5	0,4	4	SIL 50x65x11
	65	12,5	7,5	0,4	4	• SIL 50x65x12.5
55	65	11	5	0,3	2,5	SIL 55x65x11
	70	12,5	7,5	0,4	4	SIL 55x70x12.5

• Dimensions in accordance with ISO 5597

Dimensions						Designation
d f8 or h9	D H10	L +0,2	S	R max.	C min.	
mm						-
56	66	11	5	0,3	2,5	SIL 56x66x11
	71	11	7,5	0,4	4	SIL 56x71x11
	71	12,5	7,5	0,4	4	• SIL 56x71x12,5
	76	16	10	0,6	5	• SIL 56x76x16
60	70	11	5	0,3	2,5	SIL 60x70x11
	70	13	5	0,3	2,5	SIL 60x70x13
	75	11	7,5	0,4	4	SIL 60x75x11
	75	13	7,5	0,4	4	SIL 60x75x13
63	73	13	5	0,3	2,5	SIL 63x73x13
	78	11	7,5	0,4	4	SIL 63x78x11
	78	12,5	7,5	0,4	4	• SIL 63x78x12,5
	83	13	10	0,6	5	SIL 63x83x13
	83	16	10	0,6	5	• SIL 63x83x16
65	75	13	5	0,3	2,5	SIL 65x75x13
70	80	9	5	0,3	2,5	SIL 70x80x9
	80	12,5	5	0,3	2,5	SIL 70x80x12,5
	85	11	7,5	0,4	4	SIL 70x85x11
	85	12,5	7,5	0,4	4	• SIL 70x85x12,5
	90	13	10	0,6	5	SIL 70x90x13
	90	16	10	0,6	5	• SIL 70x90x16
75	85	12,5	5	0,3	2,5	SIL 75x85x12,5
	90	12,5	7,5	0,4	4	SIL 75x90x12,5
80	90	11	5	0,3	2,5	SIL 80x90x11
	90	13	5	0,3	2,5	SIL 80x90x13
	95	11	7,5	0,4	4	SIL 80x95x11
	95	12,5	7,5	0,4	4	• SIL 80x95x12,5
	100	13	10	0,6	5	SIL 80x100x13
	100	16	10	0,6	5	• SIL 80x100x16
85	100	12,5	7,5	0,4	4	SIL 85x100x12,5
	105	13	10	0,6	5	SIL 85x105x13
90	105	12,5	7,5	0,4	4	• SIL 90x105x12,5
	110	13	10	0,6	5	SIL 90x110x13
	110	16	10	0,6	5	• SIL 90x110x16
95	110	12,5	7,5	0,4	4	SIL 95x110x12,5
	115	13	10	0,6	5	SIL 95x115x13
100	115	13	7,5	0,4	4	SIL 100x115x13
	120	13	10	0,6	5	SIL 100x120x13
	120	16	10	0,6	5	• SIL 100x120x16
105	115	11	5	0,3	2,5	SIL 105x115x11
	125	13	10	0,6	5	SIL 105x125x13
110	130	16	10	0,6	5	• SIL 110x130x16
120	140	13	10	0,6	5	SIL 120x140x13
	140	16	10	0,6	5	SIL 120x140x16
125	145	13	10	0,6	5	SIL 125x145x13
	145	16	10	0,6	5	• SIL 125x145x16
130	150	16	10	0,6	5	SIL 130x150x16
140	160	16	10	0,6	5	• SIL 140x160x16
	170	13	10	0,6	5	SIL 150x170x13
150	170	16	10	0,6	5	SIL 150x170x16

Other sizes are available on request

• Dimensions in accordance with ISO 5597

PTB profile data



Material codes	Sealing ring: U-1003 X-ring: A-8501 For additional information → page 26
Pressure	Up to 400 bar (5 800 psi)
Speed	Up to 1 m/s (3.2 ft/s)
Temperature range	<div style="display: flex; align-items: center;"> <div style="margin-left: 10px;"> <p> ■ Extreme low temperature range: may be intermittently exposed (e.g. cold start-up) without seal damage, but seal performance may be compromised while in this range ■ Temperatures below the recommended operating range: seal performance depends on system design (precision guiding arrangement recommended) ■ Recommended operating temperature range for this profile and material ■ Temperatures above the recommended operating range: acceptable only with reduced pressure, speed, e-gap and/or with the use of a full-face anti-extrusion ring ■ Extreme high temperature range: only occasional short-term exposure (e.g. cylinder in curing oven of a powder coating process) </p> </div> </div>
Dimension standards	Some metric sizes fit seal housings in accordance with ISO 5597.
Counter-surface	→ page 22

Maximum values of application parameters (e.g. pressure, speed, temperature, e-gap) should not be applied continuously nor simultaneously.

3.4 PTB profile rod seals, metric sizes d 8–17 mm

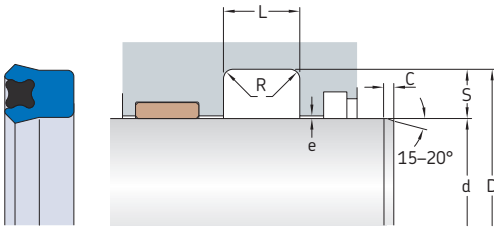

Maximum extrusion gap e

Radial depth S mm	e_{max} at 60 °C (140 °F) for pressures		
	160 bar	250 bar	400 bar
3	0,2	0,1	–
3,5 to 4	0,35	0,2	–
4,5 to 6,5	0,45	0,25	0,1
7 to 8	0,5	0,3	0,15
9 to 11,5	0,55	0,3	0,15
12,5	0,6	0,3	0,2
15	0,6	0,3	0,2

For additional information → page 34

Dimensions						Designation
d f8 or h9	D H10	L +0,2	S	R max.	C min.	
mm						–
8	16	6,3	4	0,2	6	• PTB-8x16x6.3-J1S
9	17	6,3	4	0,2	6	PTB-9x17x6.3-J1S
	19	8,8	5	0,2	6	PTB-9x19x8.8-J1S
10	16	6,6	3	0,2	6	PTB-10x16x6.6-J1S
	18	6,3	4	0,2	6	• PTB-10x18x6.3-J1S
	18	8,8	4	0,2	6	PTB-10x18x8.8-J1S
	20	8,3	5	0,2	6	PTB-10x20x8.3-J1S
	20	8,8	5	0,2	6	PTB-10x20x8.8-J1S
11,2	19,2	5,5	4	0,2	6	PTB-11.2x19.2x5.5-J1S
12	18	6,6	3	0,2	6	PTB-12x18x6.6-J1S
	19	5,1	3,5	0,2	6	PTB-12x19x5.1-J1S
	20	5,5	4	0,2	6	PTB-12x20x5.5-J1S
	20	7	4	0,2	6	PTB-12x20x7-J1S
	22	6,6	5	0,2	6	PTB-12x22x6.6-J1S
	22	8	5	0,2	6	• PTB-12x22x8-J1S
	22	8,8	5	0,2	6	PTB-12x22x8.8-J1S
12,5	22,5	8,8	5	0,2	6	PTB-12.5x22.5x8.8-J1S
13	19	4,4	3	0,2	6	PTB-13x19x4.4-J1S
14	21	5,1	3,5	0,2	6	PTB-14x21x5.1-J1S
	22	5,5	4	0,2	6	PTB-14x22x5.5-J1S
	24	6,1	5	0,2	6	PTB-14x24x6.1-J1S
	24	8,8	5	0,2	6	PTB-14x24x8.8-J1S
15	22	5,5	3,5	0,2	6	PTB-15x22x5.5-J1S
	25	8,8	5	0,2	6	PTB-15x25x8.8-J1S
16	22	4,4	3	0,2	6	PTB-16x22x4.4-J1S
	24	5,5	4	0,2	6	PTB-16x24x5.5-J1S
	26	8,8	5	0,2	6	PTB-16x26x8.8-J1S
17	25	11	4	0,2	6	PTB-17x25x11-J1S

• Dimensions in accordance with ISO 5597

3.4 PTB profile rod seals, metric sizes d 18 – 35 mm

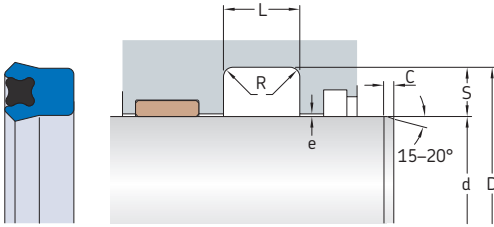

Maximum extrusion gap e

Radial depth S mm	e_{max} at 60 °C (140 °F) for pressures		
	160 bar	250 bar	400 bar
3	0,2	0,1	–
3,5 to 4	0,35	0,2	–
4,5 to 6,5	0,45	0,25	0,1
7 to 8	0,5	0,3	0,15
9 to 11,5	0,55	0,3	0,15
12,5	0,6	0,3	0,2
15	0,6	0,3	0,2

For additional information → page 34

Dimensions

d f8 or h9	D H10	L +0,2	S	R max.	C min.
---------------	----------	-----------	---	-----------	-----------

mm

Designation

–

18	25	5,1	3,5	0,2	6	PTB-18x25x5.1-J1S
	26	5,5	4	0,2	6	PTB-18x26x5.5-J1S
	28	8,8	5	0,2	6	PTB-18x28x8.8-J1S
20	26	5,5	3	0,2	6	PTB-20x26x5.5-J1S
	27	6,6	3,5	0,2	6	PTB-20x27x6.6-J1S
	28	5,5	4	0,2	6	PTB-20x28x5.5-J1S
	28	6,3	4	0,2	6	• PTB-20x28x6.3-J1S
	28	7,9	4	0,2	6	PTB-20x28x7.9-J1S
	30	6,6	5	0,2	6	PTB-20x30x6.6-J1S
	30	7,9	5	0,2	6	PTB-20x30x7.9-J1S
	30	8,8	5	0,2	6	PTB-20x30x8.8-J1S
	32	6,6	6	0,2	7	PTB-20x32x6.6-J1S
	32	8,8	6	0,2	7	PTB-20x32x8.8-J1S
	35	11	7,5	0,5	8,5	PTB-20x35x11-J1S
	35	3,2	7,5	0,5	8,5	PTB-20x35x13.2-J1S
40	3,2	10	0,8	11	PTB-20x40x13.2-J1S	
22	29	5,1	3,5	0,2	6	PTB-22x29x5.1-J1S
	30	5,5	4	0,2	6	PTB-22x30x5.5-J1S
	30	6,3	4	0,2	6	• PTB-22x30x6.3-J1S
	30	6,6	4	0,2	6	PTB-22x30x6.6-J1S
	30	7,7	4	0,2	6	PTB-22x30x7.7-J1S
	30	8,8	4	0,2	6	PTB-22x30x8.8-J1S
	32	6,6	5	0,2	6	PTB-22x32x6.6-J1S
	32	8	5	0,2	6	• PTB-22x32x8-J1S
	32	8,8	5	0,2	6	PTB-22x32x8.8-J1S
	35	8,8	6,5	0,2	7,5	PTB-22x35x8.8-J1S
35	11	6,5	0,2	7,5	PTB-22x35x11-J1S	
40	3,2	9	0,8	11	PTB-22x40x13.2-J1S	
22,4	30	5,5	3,8	0,2	6	PTB-22.4x30x5.5-J1S
	32,4	8,8	5	0,2	6	PTB-22.4x32.4x8.8-J1S
23,5	31,5	5,5	4	0,2	6	PTB-23.5x31.5x5.5-J1S

• Dimensions in accordance with ISO 5597

Dimensions						Designation	
d f8 or h9	D H10	L +0,2	S	R max.	C min.		
mm						-	
25	33	5,5	4	0,2	6	PTB-25x33x5.5-J1S	
	33	6,1	4	0,2	6	PTB-25x33x6.1-J1S	
	33	6,3	4	0,2	6	PTB-25x33x6.3-J1S	
	33	8,8	4	0,2	6	PTB-25x33x8.8-J1S	
	33	11	4	0,2	6	PTB-25x33x11-J1S	
	35	8	5	0,2	6	• PTB-25x35x8-J1S	
	35	8,8	5	0,2	6	PTB-25x35x8.8-J1S	
	35	11	5	0,2	6	PTB-25x35x11-J1S	
	38	8,8	6,5	0,2	7,5	PTB-25x38x8.8-J1S	
	38	11	6,5	0,2	7,5	PTB-25x38x11-J1S	
	40	11	7,5	0,5	8,5	PTB-25x40x11-J1S	
	28	35	5,5	3,5	0,2	6	PTB-28x35.5x5.5-J1S
36		5,8	4	0,2	6	PTB-28x36x5.8-J1S	
36		8,8	4	0,2	6	PTB-28x36x8.8-J1S	
37		8,6	4,5	0,2	6	PTB-28x37.5x8.6-J1S	
38		8	5	0,2	6	• PTB-28x38x8-J1S	
38		8,8	5	0,2	6	PTB-28x38x8.8-J1S	
38		11	5	0,2	6	PTB-28x38x11-J1S	
40		6,6	6	0,2	7	PTB-28x40x6.6-J1S	
40		11	6	0,2	7	PTB-28x40x11-J1S	
43		11,2	7,5	0,5	8,5	PTB-28x43x11.2-J1S	
48		13,2	10	0,8	11	PTB-28x48x13.2-J1S	
30		37	6,6	3,5	0,2	6	PTB-30x37x6.6-J1S
	38	6,3	4	0,2	6	PTB-30x38x6.3-J1S	
	38	6,9	4	0,2	6	PTB-30x38x6.9-J1S	
	38	8,8	4	0,2	6	PTB-30x38x8.8-J1S	
	40	6,6	5	0,2	6	PTB-30x40x6.6-J1S	
	40	7,2	5	0,2	6	PTB-30x40x7.2-J1S	
	40	8	5	0,2	6	PTB-30x40x8-J1S	
	40	11	5	0,2	6	PTB-30x40x11-J1S	
	42	9,9	6	0,2	7	PTB-30x42x9.9-J1S	
	42	11	6	0,2	7	PTB-30x42x11-J1S	
	45	9,9	7,5	0,5	8,5	PTB-30x45x9.9-J1S	
	45	11	7,5	0,5	8,5	PTB-30x45x11-J1S	
50	11	10	0,8	11	PTB-30x50x11-J1S		
31,5	41,5	6,6	5	0,2	6	PTB-31.5x41.5x6.6-J1S	
32	40	6,3	4	0,2	6	PTB-32x40x6.3-J1S	
	40	8,3	4	0,2	6	PTB-32x40x8.3-J1S	
	40	8,8	4	0,2	6	PTB-32x40x8.8-J1S	
	42	8	5	0,2	6	• PTB-32x42x8-J1S	
	42	11	5	0,2	6	PTB-32x42x11-J1S	
	44	6,1	6	0,2	7	PTB-32x44x6.1-J1S	
	44	6,9	6	0,2	7	PTB-32x44x6.9-J1S	
	45	11	6,5	0,2	7,5	PTB-32x45x11-J1S	
	47	11	7,5	0,5	8,5	PTB-32x47x11-J1S	
	48	11	8	0,5	8,5	PTB-32x48x11-J1S	
	33	40	8,8	3,5	0,2	6	PTB-33x40x8.8-J1S
		43	11	5	0,2	6	PTB-33x43x11-J1S
35	43	7	4	0,2	6	PTB-35x43x7-J1S	
	43	8,8	4	0,2	6	PTB-35x43x8.8-J1S	
	45	6,6	5	0,2	6	PTB-35x45x6.6-J1S	
	45	8	5	0,2	6	PTB-35x45x8-J1S	
	45	8,8	5	0,2	6	PTB-35x45x8.8-J1S	
	45	11	5	0,2	6	PTB-35x45x11-J1S	

• Dimensions in accordance with ISO 5597

3.4 PTB profile rod seals, metric sizes d 35 – 60 mm

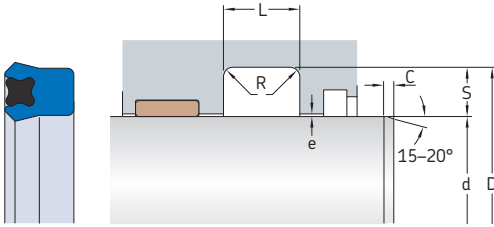

Maximum extrusion gap e

Radial depth S mm	e_{max} at 60 °C (140 °F) for pressures		
	160 bar	250 bar	400 bar
3	0,2	0,1	–
3,5 to 4	0,35	0,2	–
4,5 to 6,5	0,45	0,25	0,1
7 to 8	0,5	0,3	0,15
9 to 11,5	0,55	0,3	0,15
12,5	0,6	0,3	0,2
15	0,6	0,3	0,2

For additional information → page 34

Dimensions

d f8 or h9	D H10	L +0,2	S	R max.	C min.
---------------	----------	-----------	---	-----------	-----------

mm

Designation

–

35	50	9,9	7,5	0,5	8,5	PTB-35x50x9.9-J1S
cont.	50	11	7,5	0,5	8,5	PTB-35x50x11-J1S
	50	2,5	7,5	0,5	8,5	PTB-35x50x12.5-J1S
	51	11	8	0,5	8,5	PTB-35x51x11-J1S
	55	11	10	0,8	11	PTB-35x55x11-J1S
35,5	45	6,6	4,75	0,2	6	PTB-35.5x45x6.6-J1S
36	44	5,8	4	0,2	6	PTB-36x44x5.8-J1S
	44	6,6	4	0,2	6	PTB-36x44x6.6-J1S
	44	8,8	4	0,2	6	PTB-36x44x8.8-J1S
	46	8,8	5	0,2	6	PTB-36x46x8.8-J1S
	46	11	5	0,2	6	PTB-36x46x11-J1S
	52	11	8	0,5	8,5	PTB-36x52x11-J1S
37	47	8,8	5	0,2	6	PTB-37x47x8.8-J1S
	47	5,5	5	0,2	6	PTB-37x47x5.5-J1S
40	48	5,5	4	0,2	6	PTB-40x48x5.5-J1S
	48	6,6	4	0,2	6	PTB-40x48x6.6-J1S
	48	8,8	4	0,2	6	PTB-40x48x8.8-J1S
	50	6,6	5	0,2	6	PTB-40x50x6.6-J1S
	50	7,2	5	0,2	6	PTB-40x50x7.2-J1S
	50	8	5	0,2	6	• PTB-40x50x8-J1S
	50	8,8	5	0,2	6	PTB-40x50x8.8-J1S
	50	11	5	0,2	6	PTB-40x50x11-J1S
	53	8,8	6,5	0,2	7,5	PTB-40x53x8.8-J1S
	55	9,9	7,5	0,5	8,5	PTB-40x55x9.9-J1S
	55	11	7,5	0,5	8,5	PTB-40x55x11-J1S
	56	11	8	0,5	8,5	PTB-40x56x11-J1S
	60	13,2	10	0,8	11	PTB-40x60x13.2-J1S
41,7	50,7	7,8	4,5	0,2	6	PTB-41.7x50.7x7.8-J1S
42	55	7,7	6,5	0,2	7,5	PTB-42x55x7.7-J1S

• Dimensions in accordance with ISO 5597

Dimensions						Designation	
d f8 or h9	D H10	L +0,2	S	R max.	C min.		
mm						-	
45	53	5,8	4	0,2	6	PTB-45x53x5.8-J1S	
	53	8,8	4	0,2	6	PTB-45x53x8.8-J1S	
	55	6,6	5	0,2	6	PTB-45x55x6.6-J1S	
	55	8	5	0,2	6	• PTB-45x55x8-J1S	
	55	11	5	0,2	6	PTB-45x55x11-J1S	
	56	7,7	5,5	0,2	7	PTB-45x56x7.7-J1S	
	60	9,9	7,5	0,5	8,5	PTB-45x60x9.9-J1S	
	60	11	7,5	0,5	8,5	PTB-45x60x11-J1S	
	60	12,7	7,5	0,5	8,5	PTB-45x60x12.7-J1S	
	63	13,2	9	0,8	11	PTB-45x63x13.2-J1S	
	65	13,2	10	0,8	11	PTB-45x65x13.2-J1S	
	70	16,5	12,5	0,8	13	PTB-45x70x16.5-J1S	
	48	63	11,2	7,5	0,5	8,5	PTB-48x63x11.2-J1S
		68	13,2	10	0,8	11	PTB-48x68x13.2-J1S
50	58	8,8	4	0,2	6	PTB-50x58x8.8-J1S	
	60	6,6	5	0,2	6	• PTB-50x60x6.6-J1S	
	60	8	5	0,2	6	• PTB-50x60x8-J1S	
	60	8,8	5	0,2	6	PTB-50x60x8.8-J1S	
	60	11	5	0,2	6	PTB-50x60x11-J1S	
	60	13,2	5	0,2	6	PTB-50x60x13.2-J1S	
	63	8,8	6,5	0,2	7,5	PTB-50x63x8.8-J1S	
	63	11	6,5	0,2	7,5	PTB-50x63x11-J1S	
	65	9,9	7,5	0,5	8,5	PTB-50x65x9.9-J1S	
	65	11	7,5	0,5	8,5	PTB-50x65x11-J1S	
	65	12,5	7,5	0,5	8,5	PTB-50x65x12.5-J1S	
	70	11	10	0,8	11	PTB-50x70x11-J1S	
	70	13,2	10	0,8	11	PTB-50x70x13.2-J1S	
	53	63	6,6	5	0,2	6	PTB-53x63x6.6-J1S
63		11	5	0,2	6	PTB-53x63x11-J1S	
55	65	6,6	5	0,2	6	PTB-55x65x6.6-J1S	
	65	11	5	0,2	6	PTB-55x65x11-J1S	
	65	13,2	5	0,2	6	PTB-55x65x13.2-J1S	
	68	11	6,5	0,2	7,5	PTB-55x68x11-J1S	
	70	9,9	7,5	0,5	8,5	PTB-55x70x9.9-J1S	
	70	13,2	7,5	0,5	8,5	PTB-55x70x13.2-J1S	
	75	13,2	10	0,8	11	PTB-55x75x13.2-J1S	
80	6,5	12,5	0,8	13	PTB-55x80x16.5-J1S		
56	64	8,8	4	0,2	6	PTB-56x64x8.8-J1S	
	66	6,6	5	0,2	6	PTB-56x66x6.6-J1S	
	66	11	5	0,2	6	PTB-56x66x11-J1S	
	71	2,5	7,5	0,5	8,5	PTB-56x71x12.5-J1S	
57	70	9,9	6,5	0,2	7,5	PTB-57x70x9.9-J1S	
60	68	8,8	4	0,2	6	PTB-60x68x8.8-J1S	
	70	6,6	5	0,2	6	PTB-60x70x6.6-J1S	
	70	8,8	5	0,2	6	PTB-60x70x8.8-J1S	
	70	9,9	5	0,2	6	PTB-60x70x9.9-J1S	
	70	11	5	0,2	6	PTB-60x70x11-J1S	
	70	13,2	5	0,2	6	PTB-60x70x13.2-J1S	

• Dimensions in accordance with ISO 5597

3.4 PTB profile rod seals, metric sizes d 60 – 85 mm

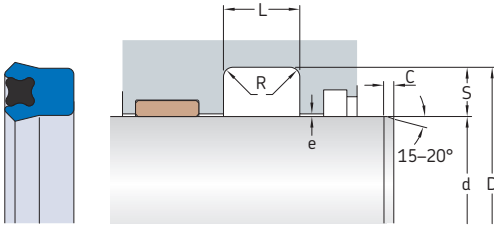

Maximum extrusion gap e

Radial depth S	e _{max} at 60 °C (140 °F) for pressures		
	160 bar	250 bar	400 bar
mm	mm		
3	0,2	0,1	–
3,5 to 4	0,35	0,2	–
4,5 to 6,5	0,45	0,25	0,1
7 to 8	0,5	0,3	0,15
9 to 11,5	0,55	0,3	0,15
12,5	0,6	0,3	0,2
15	0,6	0,3	0,2

For additional information → page 34

Dimensions

Designation

d f8 or h9	D H10	L +0,2	S	R max.	C min.	
mm						–
60 cont.	71	7,7	5,5	0,2	7	PTB-60x71x7.7-J1S
	73	11	6,5	0,2	7,5	PTB-60x73x11-J1S
	75	9,9	7,5	0,5	8,5	PTB-60x75x9.9-J1S
	75	11	7,5	0,5	8,5	PTB-60x75x11-J1S
	75	12,1	7,5	0,5	8,5	PTB-60x75x12.1-J1S
80	80	13,2	10	0,8	11	PTB-60x80x13.2-J1S
	80	16	10	0,8	11	PTB-60x80x16-J1S
62	72	13,2	5	0,2	6	PTB-62x72x13.2-J1S
63	71	8,8	4	0,2	6	PTB-63x71x8.8-J1S
	73	6,6	5	0,2	6	PTB-63x73x6.6-J1S
	73	13,2	5	0,2	6	PTB-63x73x13.2-J1S
	75	9,6	6	0,2	7	PTB-63x75x9.6-J1S
	78	9,9	7,5	0,5	8,5	PTB-63x78x9.9-J1S
	78	11	7,5	0,5	8,5	PTB-63x78x11-J1S
64	78	11,7	7,5	0,5	8,5	PTB-63x78x11.7-J1S
	83	13,2	10	0,8	11	PTB-63x83x13.2-J1S
	83	16,5	10	0,8	11	PTB-63x83x16.5-J1S
	80	13,2	8	0,5	8,5	PTB-64x80x13.2-J1S
	65	73	8,8	4	0,2	6
75		6,6	5	0,2	6	PTB-65x75x6.6-J1S
75		8,8	5	0,2	6	PTB-65x75x8.8-J1S
75		11	5	0,2	6	PTB-65x75x11-J1S
75		13,2	5	0,2	6	PTB-65x75x13.2-J1S
78		11	6,5	0,2	7,5	PTB-65x78x11-J1S
80		9,9	7,5	0,5	8,5	PTB-65x80x9.9-J1S
80		11	7,5	0,5	8,5	PTB-65x80x11-J1S
80		13,2	7,5	0,5	8,5	PTB-65x80x13.2-J1S
85		13,2	10	0,8	11	PTB-65x85x13.2-J1S
67	77	6,6	5	0,2	6	PTB-67x77x6.6-J1S

Dimensions						Designation
d f8 or h9	D H10	L +0,2	S	R max.	C min.	
mm						-
70	78	8,8	4	0,2	6	PTB-70x78x8.8-J1S
	80	6,6	5	0,2	6	PTB-70x80x6.6-J1S
	80	11	5	0,2	6	PTB-70x80x11-J1S
	80	13,2	5	0,2	6	PTB-70x80x13.2-J1S
	83	11	6,5	0,2	7,5	PTB-70x83x11-J1S
	85	9,9	7,5	0,5	8,5	PTB-70x85x9.9-J1S
	85	11	7,5	0,5	8,5	PTB-70x85x11-J1S
	85	12,5	7,5	0,5	8,5	• PTB-70x85x12.5-J1S
	85	13,2	7,5	0,5	8,5	PTB-70x85x13.2-J1S
	90	13,2	10	0,8	11	PTB-70x90x13.2-J1S
	90	16,5	10	0,8	11	PTB-70x90x16.5-J1S
	71	80	6,6	4,5	0,2	6
80		7,2	4,5	0,2	6	PTB-71x80x7.2-J1S
72	82	8,8	5	0,2	6	PTB-72x82x8.8-J1S
	87	9,9	7,5	0,5	8,5	PTB-72x87x9.9-J1S
75	83	6,6	4	0,2	6	PTB-75x83x6.6-J1S
	85	6,6	5	0,2	6	PTB-75x85x6.6-J1S
	85	8,8	5	0,2	6	PTB-75x85x8.8-J1S
	85	11	5	0,2	6	PTB-75x85x11-J1S
	85	13,2	5	0,2	6	PTB-75x85x13.2-J1S
	88	11	6,5	0,2	7,5	PTB-75x88x11-J1S
	90	6,6	7,5	0,5	8,5	PTB-75x90x6.6-J1S
	90	9,9	7,5	0,5	8,5	PTB-75x90x9.9-J1S
	90	11	7,5	0,5	8,5	PTB-75x90x11-J1S
	90	12,1	7,5	0,5	8,5	PTB-75x90x12.1-J1S
	90	12,5	7,5	0,5	8,5	PTB-75x90x12.5-J1S
	90	13,2	7,5	0,5	8,5	PTB-75x90x13.2-J1S
95	13,2	10	0,8	11	PTB-75x95x13.2-J1S	
	100	16,5	12,5	0,8	13	PTB-75x100x16.5-J1S
78	90	12,1	6	0,2	7	PTB-78x90x12.1-J1S
80	88	8,8	4	0,2	6	PTB-80x88x8.8-J1S
	90	6,6	5	0,2	6	PTB-80x90x6.6-J1S
	90	8,8	5	0,2	6	PTB-80x90x8.8-J1S
	90	11	5	0,2	6	PTB-80x90x11-J1S
	90	13,2	5	0,2	6	PTB-80x90x13.2-J1S
	92	10,5	6	0,2	7	PTB-80x92x10.5-J1S
	93	11	6,5	0,2	7,5	PTB-80x93x11-J1S
	95	9,9	7,5	0,5	8,5	PTB-80x95x9.9-J1S
	95	11	7,5	0,5	8,5	PTB-80x95x11-J1S
	95	12,1	7,5	0,5	8,5	PTB-80x95x12.1-J1S
	95	12,5	7,5	0,5	8,5	• PTB-80x95x12.5-J1S
	100	13,2	10	0,8	11	PTB-80x100x13.2-J1S
100	16	10	0,8	11	• PTB-80x100x16-J1S	
100	16,5	10	0,8	11	PTB-80x100x16.5-J1S	
82	92	11	5	0,2	6	PTB-82x92x11-J1S
84	98	13,2	7	0,5	8,5	PTB-84x98x13.2-J1S
85	95	6,6	5	0,2	6	PTB-85x95x6.6-J1S
	100	9,9	7,5	0,5	8,5	PTB-85x100x9.9-J1S
	100	11	7,5	0,5	8,5	PTB-85x100x11-J1S
	100	13,2	7,5	0,5	8,5	PTB-85x100x13.2-J1S
	105	13,2	10	0,8	11	PTB-85x105x13.2-J1S

• Dimensions in accordance with ISO 5597

3.4 PTB profile rod seals, metric sizes d 87 – 150 mm

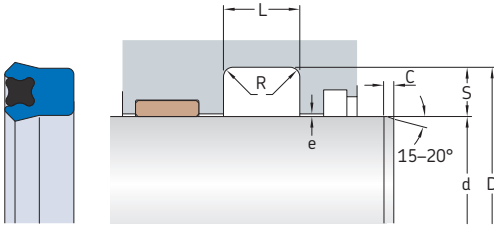

Maximum extrusion gap e

Radial depth S mm	e_{max} at 60 °C (140 °F) for pressures		
	160 bar	250 bar	400 bar
3	0,2	0,1	–
3,5 to 4	0,35	0,2	–
4,5 to 6,5	0,45	0,25	0,1
7 to 8	0,5	0,3	0,15
9 to 11,5	0,55	0,3	0,15
12,5	0,6	0,3	0,2
15	0,6	0,3	0,2

For additional information → page 34

Dimensions

d f8 to h9	D H10	L +0,2	S	R max.	C min.
---------------	----------	-----------	---	-----------	-----------

mm

Designation

–

87	110	11	11,5	0,8	13	PTB-87x110x11-J1S
88	102	11,6	7	0,5	8,5	PTB-88x102x11.6-J1S
90	98	8,8	4	0,2	6	PTB-90x98x8.8-J1S
	100	6,6	5	0,2	6	PTB-90x100x6.6-J1S
	100	7,7	5	0,2	6	PTB-90x100x7.7-J1S
	105	9,9	7,5	0,5	8,5	PTB-90x105x9.9-J1S
	105	11	7,5	0,5	8,5	PTB-90x105x11-J1S
	105	12,5	7,5	0,5	8,5	• PTB-90x105x12.5-J1S
	105	13,2	7,5	0,5	8,5	PTB-90x105x13.2-J1S
	110	13,2	10	0,8	11	PTB-90x110x13.2-J1S
	110	16	10	0,8	11	• PTB-90x110x16-J1S
	92	102	11	5	0,2	6
95	105	6,6	5	0,2	6	PTB-95x105x6.6-J1S
	110	9,9	7,5	0,5	8,5	PTB-95x110x9.9-J1S
	110	11	7,5	0,5	8,5	PTB-95x110x11-J1S
	110	13,2	7,5	0,5	8,5	PTB-95x110x13.2-J1S
	115	13,2	10	0,8	11	PTB-95x115x13.2-J1S
97	105	14,3	4	0,2	6	PTB-97x105x14.3-J1S
98	110	17,6	6	0,2	7	PTB-98x110x17.6-J1S
100	108	8,8	4	0,2	6	PTB-100x108x8.8-J1S
	115	9,9	7,5	0,5	8,5	PTB-100x115x9.9-J1S
	115	11	7,5	0,5	8,5	PTB-100x115x11-J1S
	115	13,2	7,5	0,5	8,5	PTB-100x115x13.2-J1S
	120	13,2	10	0,8	11	PTB-100x120x13.2-J1S
120	16	10	0,8	11	• PTB-100x120x16-J1S	
125	13,6	12,5	0,8	13	PTB-100x125x13.6-J1S	
125	16,5	12,5	0,8	13	PTB-100x125x16.5-J1S	
105	120	9,9	7,5	0,5	8,5	PTB-105x120x9.9-J1S

• Dimensions in accordance with ISO 5597

Dimensions						Designation
d f8 to h9	D H10	L +0,2	S	R max.	C min.	
mm						-
105 cont.	120	11	7,5	0,5	8,5	PTB-105x120x11-J1S
	125	12,5	10	0,8	11	PTB-105x125x12.5-J1S
	125	13,2	10	0,8	11	PTB-105x125x13.2-J1S
	125	16,5	10	0,8	11	PTB-105x125x16.5-J1S
109	125	11,6	8	0,5	8,5	PTB-109x125x11.6-J1S
110	125	9,9	7,5	0,5	8,5	PTB-110x125x9.9-J1S
	125	10,1	7,5	0,5	8,5	PTB-110x125x10.1-J1S
	125	11	7,5	0,5	8,5	PTB-110x125x11-J1S
	125	13,2	7,5	0,5	8,5	PTB-110x125x13.2-J1S
	130	11	10	0,8	11	PTB-110x130x11-J1S
	130	13,2	10	0,8	11	PTB-110x130x13.2-J1S
112	130	16	10	0,8	11	• PTB-110x130x16-J1S
	130	16,5	10	0,8	11	PTB-110x130x16.5-J1S
	135	19,8	12,5	0,8	13	• PTB-110x135x19.8-J1S
	125	7,7	6,5	0,2	7,5	PTB-112x125x7.7-J1S
	115	130	9,4	7,5	0,5	8,5
115	130	9,9	7,5	0,5	8,5	PTB-115x130x9.9-J1S
	135	13,2	10	0,8	11	PTB-115x135x13.2-J1S
	140	19,8	12,5	0,8	13	PTB-115x140x19.8-J1S
	118	133	9,9	7,5	0,5	8,5
120	130	16,5	5	0,2	6	PTB-120x130x16.5-J1S
	135	9,9	7,5	0,5	8,5	PTB-120x135x9.9-J1S
	140	11	10	0,8	11	PTB-120x140x11-J1S
	140	13,2	10	0,8	11	PTB-120x140x13.2-J1S
	140	16	10	0,8	11	PTB-120x140x16-J1S
	140	16,5	10	0,8	11	PTB-120x140x16.5-J1S
125	140	9,9	7,5	0,5	8,5	PTB-125x140x9.9-J1S
	140	16,5	7,5	0,5	8,5	PTB-125x140x16.5-J1S
	145	16	10	0,8	11	• PTB-125x145x16-J1S
	145	16,5	10	0,8	11	PTB-125x145x16.5-J1S
	150	19,8	12,5	0,8	13	• PTB-125x150x19.8-J1S
130	145	9,9	7,5	0,5	8,5	PTB-130x145x9.9-J1S
	150	13,2	10	0,8	11	PTB-130x150x13.2-J1S
	150	14,3	10	0,8	11	PTB-130x150x14.3-J1S
	150	16,5	10	0,8	11	PTB-130x150x16.5-J1S
	150	17,6	10	0,8	11	PTB-130x150x17.6-J1S
	160	18,7	15	0,8	14	PTB-130x160x18.7-J1S
135	150	9,9	7,5	0,5	8,5	PTB-135x150x9.9-J1S
	155	16,5	10	0,8	11	PTB-135x155x16.5-J1S
136	150	9,9	7	0,5	8,5	PTB-136x150x9.9-J1S
140	155	9,9	7,5	0,5	8,5	PTB-140x155x9.9-J1S
	160	13,2	10	0,8	11	PTB-140x160x13.2-J1S
	160	15,4	10	0,8	11	PTB-140x160x15.4-J1S
	160	16	10	0,8	11	• PTB-140x160x16-J1S
	160	16,5	10	0,8	11	PTB-140x160x16.5-J1S
145	160	7,7	7,5	0,5	8,5	PTB-145x160x7.7-J1S
	160	9,9	7,5	0,5	8,5	PTB-145x160x9.9-J1S
150	160	8,8	5	0,2	6	PTB-150x160x8.8-J1S
	165	9,9	7,5	0,5	8,5	PTB-150x165x9.9-J1S
	170	16,5	10	0,8	11	PTB-150x170x16.5-J1S
	170	17,6	10	0,8	11	PTB-150x170x17.6-J1S
	180	19,8	15	0,8	14	PTB-150x180x19.8-J1S

• Dimensions in accordance with ISO 5597

3.4 PTB profile rod seals, metric sizes d 155 – 205 mm

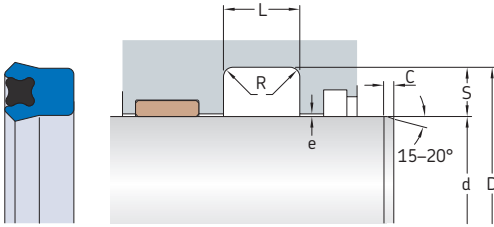

Maximum extrusion gap e

Radial depth S mm	e _{max} at 60 °C (140 °F) for pressures		
	160 bar	250 bar	400 bar
3	0,2	0,1	–
3,5 to 4	0,35	0,2	–
4,5 to 6,5	0,45	0,25	0,1
7 to 8	0,5	0,3	0,15
9 to 11,5	0,55	0,3	0,15
12,5	0,6	0,3	0,2
15	0,6	0,3	0,2

For additional information → page 34

Dimensions

d f8 or h9	D H10	L +0,2	S	R max.	C min.
---------------	----------	-----------	---	-----------	-----------

mm

Designation

–

155	180	16,5	12,5	0,8	13	PTB-155x180x16.5-J1S
	180	17,6	12,5	0,8	13	PTB-155x180x17.6-J1S
160	175	9,9	7,5	0,5	8,5	PTB-160x175x9.9-J1S
	180	16,5	10	0,8	11	PTB-160x180x16.5-J1S
	185	17,6	12,5	0,8	13	PTB-160x185x17.6-J1S
	185	19,8	12,5	0,8	13	PTB-160x185x19.8-J1S
	190	25	15	0,8	14	PTB-160x190x25-J1S
165	180	10,5	7,5	0,5	8,5	PTB-165x180x10.5-J1S
	190	17,6	12,5	0,8	13	PTB-165x190x17.6-J1S
170	190	16,5	10	0,8	11	PTB-170x190x16.5-J1S
	195	17,6	12,5	0,8	13	PTB-170x195x17.6-J1S
	200	16,5	15	0,8	14	PTB-170x200x16.5-J1S
175	185	12,5	5	0,2	6	PTB-175x185x12.5-J1S
	200	16,5	12,5	0,8	13	PTB-175x200x16.5-J1S
	200	19,8	12,5	0,8	13	PTB-175x200x19.8-J1S
180	200	13,8	10	0,8	11	PTB-180x200x13.8-J1S
	205	16,5	12,5	0,8	13	PTB-180x205x16.5-J1S
	205	17,6	12,5	0,8	13	PTB-180x205x17.6-J1S
190	210	13,2	10	0,8	11	PTB-190x210x13.2-J1S
	210	16,5	10	0,8	11	PTB-190x210x16.5-J1S
	215	16,5	12,5	0,8	13	PTB-190x215x16.5-J1S
	215	17,6	12,5	0,8	13	PTB-190x215x17.6-J1S
199	224	17,6	12,5	0,8	13	PTB-199x224x17.6-J1S
200	220	13,8	10	0,8	11	PTB-200x220x13.8-J1S
	220	16,5	10	0,8	11	PTB-200x220x16.5-J1S
	225	16,5	12,5	0,8	13	PTB-200x225x16.5-J1S
	225	17,6	12,5	0,8	13	PTB-200x225x17.6-J1S
205	235	19,8	15	0,8	14	PTB-205x235x19.8-J1S

Other sizes are available on request

3.4 PTB profile rod seals, inch sizes d 0.125 – 0.688 in.

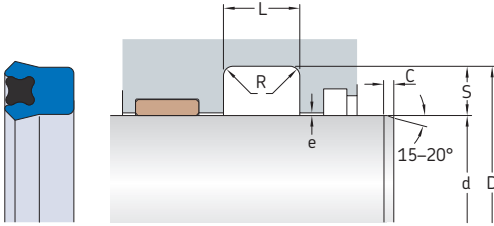

Maximum extrusion gap e

Radial depth S	e _{max} at 60 °C (140 °F) for pressures		
	2 300 psi	3 600 psi	5 800 psi
in.	in.		
0.125	0.008	0.004	–
0.156 to 0.187	0.014	0.008	–
0.218 to 0.25	0.018	0.010	0.004
0.281 to 0.437	0.020	0.012	0.006
0.5 to 0.562	0.024	0.012	0.008
0.625 to 0.75	0.024	0.012	0.008

For additional information → page 34

Dimensions

Designation

d	Tolerance	D	Tolerance	L +0.01	S	R max.	C min.	Designation
in.								–
0.125	–0.001	0.375	0.002	0.275	0.125	0.015	0.25	PTB125-125-250-J1S
0.187	–0.001 –0.001	0.437	0.002	0.206 0.275	0.125 0.125	0.015 0.015	0.25 0.25	PTB125-187-187-J1S PTB125-187-250-J1S
0.25	–0.001	0.5	0.002	0.275	0.125	0.015	0.25	PTB125-250-250-J1S
0.282	–0.001	0.532	0.002	0.275	0.125	0.015	0.25	PTB125-282-250-J1S
0.312	–0.001 –0.001	0.562	0.002	0.275 0.343	0.125 0.187	0.015 0.015	0.25 0.25	PTB125-312-250-J1S PTB187-312-312-J1S
0.375	–0.001 –0.001	0.625	0.002	0.275 0.343	0.125 0.187	0.015 0.015	0.25 0.25	PTB125-375-250-J1S PTB187-375-312-J1S
0.437	–0.001 –0.001 –0.002	0.687	0.002	0.275 0.413 0.413	0.125 0.125 0.25	0.015 0.015 0.02	0.25 0.25 0.312	PTB125-437-250-J1S PTB125-437-375-J1S PTB250-437-375-J1S
0.5	–0.001 –0.001 –0.001 –0.002	0.75	0.002	0.193 0.275 0.343 0.413	0.125 0.125 0.187 0.25	0.015 0.015 0.015 0.02	0.25 0.25 0.25 0.312	PTB125-500-175-J1S PTB125-500-250-J1S PTB187-500-312-J1S PTB250-500-375-J1S
0.54	–0.001	0.915	0.002	0.343	0.187	0.015	0.25	PTB187-540-312-J1S
0.562	–0.001 –0.001	0.812	0.002	0.275 0.343	0.125 0.187	0.015 0.015	0.25 0.25	PTB125-562-250-J1S PTB187-562-312-J1S
0.625	–0.001 –0.001 –0.001	0.875	0.002	0.196 0.275 0.343	0.125 0.125 0.187	0.015 0.015 0.015	0.25 0.25 0.25	PTB125-625-178-J1S PTB125-625-250-J1S PTB187-625-312-J1S
0.687	–0.001 –0.001 –0.002	0.937	0.002	0.275 0.343 0.413	0.125 0.187 0.25	0.015 0.015 0.02	0.25 0.25 0.312	PTB125-687-250-J1S PTB187-687-312-J1S PTB250-687-375-J1S
0.688	–0.001	0.938	0.002	0.196	0.125	0.015	0.25	PTB125-688-178-J1S

3.4 PTB profile rod seals, inch sizes d 0.75 – 1.625 in.

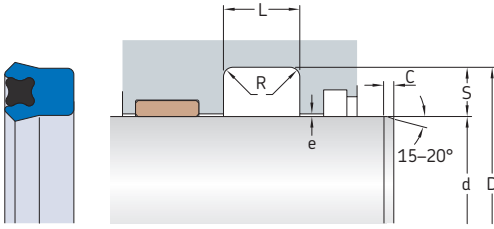

Maximum extrusion gap e

Radial depth S	e _{max} at 60 °C (140 °F) for pressures		
	2 300 psi	3 600 psi	5 800 psi
in.	in.		
0.125	0.008	0.004	–
0.156 to 0.187	0.014	0.008	–
0.218 to 0.25	0.018	0.01	0.004
0.281 to 0.437	0.02	0.012	0.006
0.5 to 0.562	0.024	0.012	0.008
0.625 to 0.75	0.024	0.012	0.008

For additional information → page 34

Dimensions

Designation

d	Tolerance	D	Tolerance	L +0.01	S	R max.	C min.	Designation	
in.								–	
0.75	–0.001	1	0.002	0.196	0.125	0.015	0.25	PTB125-750-178-J15	
	–0.001	1	0.002	0.206	0.125	0.015	0.25	PTB125-750-187-J15	
	–0.001	1	0.002	0.275	0.125	0.015	0.25	PTB125-750-250-J15	
	–0.001	1.125	0.002	0.343	0.187	0.015	0.25	PTB187-750-312-J15	
	–0.002	1.25	0.003	0.413	0.25	0.02	0.312	PTB250-750-375-J15	
–0.002	1.375	0.004	0.55	0.312	0.02	0.312	PTB312-750-500-J15		
0.812	–0.001	1.062	0.002	0.275	0.125	0.015	0.25	PTB125-812-250-J15	
	–0.001	1.187	0.002	0.343	0.187	0.015	0.25	PTB187-812-312-J15	
	–0.002	1.312	0.003	0.413	0.25	0.02	0.312	PTB250-812-375-J15	
0.875	–0.001	1.125	0.002	0.275	0.125	0.015	0.25	PTB125-875-250-J15	
	–0.001	1.25	0.002	0.343	0.187	0.015	0.25	PTB187-875-312-J15	
	–0.002	1.375	0.003	0.413	0.25	0.02	0.312	PTB250-875-375-J15	
0.937	–0.001	1.187	0.002	0.275	0.125	0.015	0.25	PTB125-937-250-J15	
	–0.001	1.312	0.002	0.343	0.187	0.015	0.25	PTB187-937-312-J15	
	–0.002	1.562	0.004	0.413	0.312	0.02	0.312	PTB312-937-375-J15	
1	–0.001	1.25	0.002	0.206	0.125	0.015	0.25	PTB125-1000-187-J15	
	–0.001	1.25	0.002	0.275	0.125	0.015	0.25	PTB125-1000-250-J15	
	–0.001	1.312	0.002	0.24	0.156	0.015	0.25	PTB156-1000-218-J15	
	–0.001	1.312	0.002	0.257	0.156	0.015	0.25	PTB156-1000-234-J15	
	–0.001	1.375	0.002	0.275	0.187	0.015	0.25	PTB187-1000-250-J15	
	–0.001	1.375	0.002	0.293	0.187	0.015	0.25	PTB187-1000-266-J15	
	–0.001	1.375	0.002	0.343	0.187	0.015	0.25	PTB187-1000-312-J15	
	–0.001	1.375	0.002	0.413	0.187	0.015	0.25	PTB187-1000-375-J15	
	–0.002	1.5	0.003	0.413	0.25	0.02	0.312	PTB250-1000-375-J15	
	–0.002	1.625	0.004	0.413	0.312	0.02	0.312	PTB312-1000-375-J15	
	–0.002	1.625	0.004	0.55	0.312	0.02	0.312	PTB312-1000-500-J15	
	1.062	–0.001	1.312	0.002	0.275	0.125	0.015	0.25	PTB125-1062-250-J15
		–0.001	1.437	0.002	0.343	0.187	0.015	0.25	PTB187-1062-312-J15
1.125	–0.001	1.375	0.002	0.275	0.125	0.015	0.25	PTB125-1125-250-J15	
	–0.001	1.5	0.002	0.275	0.187	0.015	0.25	PTB187-1125-250-J15	
	–0.001	1.5	0.002	0.343	0.187	0.015	0.25	PTB187-1125-312-J15	
	–0.001	1.5	0.002	0.413	0.187	0.015	0.25	PTB187-1125-375-J15	
	–0.002	1.625	0.003	0.413	0.25	0.02	0.312	PTB250-1125-375-J15	
	–0.002	1.75	0.004	0.413	0.312	0.02	0.312	PTB312-1125-375-J15	

Dimensions								Designation	
d	Tolerance	D	Tolerance	L +0.01	S	R max.	C min.		
in.								-	
1.187	-0.001	1.437	0.002	0.196	0.125	0.015	0.25	PTB125-1187-178-J15	
	-0.001	1.437	0.002	0.206	0.125	0.015	0.25	PTB125-1187-187-J15	
	-0.001	1.437	0.002	0.275	0.125	0.015	0.25	PTB125-1187-250-J15	
	-0.001	1.562	0.002	0.275	0.187	0.015	0.25	PTB187-1187-250-J15	
	-0.001	1.562	0.002	0.343	0.187	0.015	0.25	PTB187-1187-312-J15	
1.25	-0.001	1.5	0.002	0.206	0.125	0.015	0.25	PTB125-1250-187-J15	
	-0.001	1.5	0.002	0.275	0.125	0.015	0.25	PTB125-1250-250-J15	
	-0.001	1.625	0.002	0.275	0.187	0.015	0.25	PTB187-1250-250-J15	
	-0.001	1.625	0.002	0.293	0.187	0.015	0.25	PTB187-1250-266-J15	
	-0.001	1.625	0.002	0.343	0.187	0.015	0.25	PTB187-1250-312-J15	
	-0.001	1.625	0.002	0.413	0.187	0.015	0.25	PTB187-1250-375-J15	
	-0.002	1.75	0.003	0.413	0.25	0.02	0.312	PTB250-1250-375-J15	
	-0.002	1.875	0.004	0.413	0.312	0.02	0.312	PTB312-1250-375-J15	
	-0.002	1.875	0.004	0.55	0.312	0.02	0.312	PTB312-1250-500-J15	
	-0.003	2.25	0.007	0.825	0.5	0.03	0.625	PTB500-1250-750-J15	
	1.312	-0.001	1.562	0.002	0.206	0.125	0.015	0.25	PTB125-1312-187-J15
		-0.001	1.687	0.002	0.343	0.187	0.015	0.25	PTB187-1312-312-J15
-0.002		1.812	0.003	0.413	0.25	0.02	0.312	PTB250-1312-375-J15	
1.375	-0.001	1.625	0.002	0.275	0.125	0.015	0.25	PTB125-1375-250-J15	
	-0.001	1.687	0.002	0.24	0.156	0.015	0.25	PTB156-1375-218-J15	
	-0.001	1.75	0.002	0.275	0.187	0.015	0.25	PTB187-1375-250-J15	
	-0.001	1.75	0.002	0.293	0.187	0.015	0.25	PTB187-1375-266-J15	
	-0.001	1.75	0.002	0.343	0.187	0.015	0.25	PTB187-1375-312-J15	
	-0.001	1.75	0.002	0.413	0.187	0.015	0.25	PTB187-1375-375-J15	
	-0.002	1.875	0.003	0.413	0.25	0.02	0.312	PTB250-1375-375-J15	
	-0.002	2	0.004	0.413	0.312	0.02	0.312	PTB312-1375-375-J15	
	-0.002	2	0.004	0.55	0.312	0.02	0.312	PTB312-1375-500-J15	
	1.437	-0.001	1.687	0.002	0.275	0.125	0.015	0.25	PTB125-1437-250-J15
-0.001		1.812	0.002	0.343	0.187	0.015	0.25	PTB187-1437-312-J15	
-0.002		1.937	0.003	0.413	0.25	0.02	0.312	PTB250-1437-375-J15	
1.5	-0.001	1.75	0.002	0.206	0.125	0.015	0.25	PTB125-1500-187-J15	
	-0.001	1.75	0.002	0.275	0.125	0.015	0.25	PTB125-1500-250-J15	
	-0.001	1.812	0.002	0.343	0.156	0.015	0.25	PTB156-1500-312-J15	
	-0.001	1.875	0.002	0.275	0.187	0.015	0.25	PTB187-1500-250-J15	
	-0.001	1.875	0.002	0.286	0.187	0.015	0.25	PTB187-1500-260-J15	
	-0.001	1.875	0.002	0.293	0.187	0.015	0.25	PTB187-1500-266-J15	
	-0.001	1.875	0.002	0.343	0.187	0.015	0.25	PTB187-1500-312-J15	
	-0.001	1.875	0.002	0.413	0.187	0.015	0.25	PTB187-1500-375-J15	
	-0.002	2	0.003	0.343	0.25	0.02	0.312	PTB250-1500-312-J15	
	-0.002	2	0.003	0.413	0.25	0.02	0.312	PTB250-1500-375-J15	
	-0.002	2	0.003	0.55	0.25	0.02	0.312	PTB250-1500-500-J15	
	-0.002	2.125	0.004	0.481	0.312	0.02	0.312	PTB312-1500-437-J15	
	-0.002	2.125	0.004	0.55	0.312	0.02	0.312	PTB312-1500-500-J15	
	-0.002	2.25	0.005	0.55	0.375	0.03	0.5	PTB375-1500-500-J15	
	-0.002	2.25	0.005	0.688	0.375	0.03	0.5	PTB375-1500-625-J15	
1.562	-0.001	1.937	0.002	0.413	0.187	0.015	0.25	PTB187-1562-375-J15	
	-0.002	2	0.003	0.343	0.218	0.02	0.312	PTB218-1562-312-J15	
	-0.002	2.062	0.003	0.343	0.25	0.02	0.312	PTB250-1562-312-J15	
1.625	-0.001	2	0.002	0.275	0.187	0.015	0.25	PTB187-1625-250-J15	
	-0.001	2	0.002	0.293	0.187	0.015	0.25	PTB187-1625-266-J15	
	-0.001	2	0.002	0.343	0.187	0.015	0.25	PTB187-1625-312-J15	
	-0.001	2	0.002	0.413	0.187	0.015	0.25	PTB187-1625-375-J15	

3.4

3.4 PTB profile rod seals, inch sizes d 1.625 – 2.5 in.

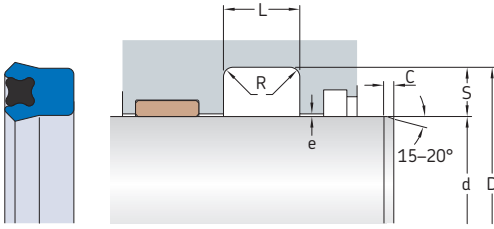

Maximum extrusion gap e

Radial depth S	e _{max} at 60 °C (140 °F) for pressures		
	2 300 psi	3 600 psi	5 800 psi
in.	in.		
0.125	0.008	0.004	–
0.156 to 0.187	0.014	0.008	–
0.218 to 0.25	0.018	0.01	0.004
0.281 to 0.437	0.02	0.012	0.006
0.5 to 0.562	0.024	0.012	0.008
0.625 to 0.75	0.024	0.012	0.008

For additional information → page 34

Dimensions

Designation

d	Tolerance	D	Tolerance	L +0.01	S	R max.	C min.	Designation
in.								–
1.625	–0.002	2.125	0.003	0.413	0.25	0.02	0.312	PTB250-1625-375-J15
cont.	–0.002	2.25	0.004	0.413	0.312	0.02	0.312	PTB312-1625-375-J15
	–0.002	2.25	0.004	0.55	0.312	0.02	0.312	PTB312-1625-500-J15
	–0.002	2.375	0.005	0.688	0.375	0.03	0.5	PTB375-1625-625-J15
1.687	–0.002	2.312	0.004	0.55	0.312	0.02	0.312	PTB312-1687-500-J15
1.75	–0.001	2	0.002	0.275	0.125	0.015	0.25	PTB125-1750-250-J15
	–0.001	2.125	0.002	0.275	0.187	0.015	0.25	PTB187-1750-250-J15
	–0.001	2.125	0.002	0.293	0.187	0.015	0.25	PTB187-1750-266-J15
	–0.001	2.125	0.002	0.343	0.187	0.015	0.25	PTB187-1750-312-J15
	–0.001	2.125	0.002	0.413	0.187	0.015	0.25	PTB187-1750-375-J15
	–0.002	2.25	0.003	0.343	0.25	0.02	0.312	PTB250-1750-312-J15
	–0.002	2.25	0.003	0.413	0.25	0.02	0.312	PTB250-1750-375-J15
	–0.002	2.375	0.004	0.413	0.312	0.02	0.312	PTB312-1750-375-J15
	–0.002	2.375	0.004	0.55	0.312	0.02	0.312	PTB312-1750-500-J15
	–0.002	2.5	0.005	0.688	0.375	0.03	0.5	PTB375-1750-625-J15
	–0.003	2.75	0.007	0.825	0.5	0.03	0.625	PTB500-1750-750-J15
1.875	–0.001	2.25	0.002	0.293	0.187	0.015	0.25	PTB187-1875-266-J15
	–0.001	2.25	0.002	0.343	0.187	0.015	0.25	PTB187-1875-312-J15
	–0.001	2.25	0.002	0.413	0.187	0.015	0.25	PTB187-1875-375-J15
	–0.002	2.375	0.003	0.413	0.25	0.02	0.312	PTB250-1875-375-J15
	–0.002	2.5	0.004	0.413	0.312	0.02	0.312	PTB312-1875-375-J15
	–0.002	2.5	0.004	0.55	0.312	0.02	0.312	PTB312-1875-500-J15
	–0.003	2.875	0.007	0.688	0.5	0.03	0.625	PTB500-1875-625-J15
2	–0.001	2.25	0.002	0.275	0.125	0.015	0.25	PTB125-2000-250-J15
	–0.001	2.375	0.002	0.253	0.187	0.015	0.25	PTB187-2000-230-J15
	–0.001	2.375	0.002	0.275	0.187	0.015	0.25	PTB187-2000-250-J15
	–0.001	2.375	0.002	0.343	0.187	0.015	0.25	PTB187-2000-312-J15
	–0.001	2.375	0.002	0.391	0.187	0.015	0.25	PTB187-2000-355-J15
	–0.001	2.375	0.002	0.413	0.187	0.015	0.25	PTB187-2000-375-J15
	–0.002	2.5	0.003	0.343	0.25	0.02	0.312	PTB250-2000-312-J15
	–0.002	2.5	0.003	0.413	0.25	0.02	0.312	PTB250-2000-375-J15
	–0.002	2.5	0.003	0.55	0.25	0.02	0.312	PTB250-2000-500-J15

Dimensions								Designation
d	Tolerance	D	Tolerance	L +0.01	S	R max.	C min.	
in.								-
2 cont.	-0.002	2.625	0.004	0.413	0.312	0.02	0.312	PTB312-2000-375-J1S
	-0.002	2.625	0.004	0.481	0.312	0.02	0.312	PTB312-2000-437-J1S
	-0.002	2.625	0.004	0.55	0.312	0.02	0.312	PTB312-2000-500-J1S
	-0.002	2.75	0.005	0.481	0.375	0.03	0.5	PTB375-2000-437-J1S
	-0.002	2.75	0.005	0.55	0.375	0.03	0.5	PTB375-2000-500-J1S
	-0.002	2.75	0.005	0.688	0.375	0.03	0.5	PTB375-2000-625-J1S
	-0.003	3	0.007	0.825	0.5	0.03	0.625	PTB500-2000-750-J1S
2.125	-0.001	2.5	0.002	0.275	0.187	0.015	0.25	PTB187-2125-250-J1S
	-0.001	2.5	0.002	0.293	0.187	0.015	0.25	PTB187-2125-266-J1S
	-0.001	2.5	0.002	0.343	0.187	0.015	0.25	PTB187-2125-312-J1S
	-0.001	2.5	0.002	0.413	0.187	0.015	0.25	PTB187-2125-375-J1S
	-0.002	2.625	0.003	0.413	0.25	0.02	0.312	PTB250-2125-375-J1S
	-0.002	2.75	0.004	0.413	0.312	0.02	0.312	PTB312-2125-375-J1S
	-0.002	2.75	0.004	0.55	0.312	0.02	0.312	PTB312-2125-500-J1S
	-0.002	2.875	0.005	0.688	0.375	0.03	0.5	PTB375-2125-625-J1S
2.187	-0.001	2.562	0.002	0.413	0.187	0.015	0.25	PTB187-2187-375-J1S
	-0.002	2.687	0.003	0.413	0.25	0.02	0.312	PTB250-2187-375-J1S
	-0.002	2.937	0.005	0.688	0.375	0.03	0.5	PTB375-2187-625-J1S
2.25	-0.001	2.625	0.002	0.343	0.187	0.015	0.25	PTB187-2250-312-J1S
	-0.001	2.625	0.002	0.413	0.187	0.015	0.25	PTB187-2250-375-J1S
	-0.002	2.75	0.003	0.413	0.25	0.02	0.312	PTB250-2250-375-J1S
	-0.002	2.875	0.004	0.413	0.312	0.02	0.312	PTB312-2250-375-J1S
	-0.002	2.875	0.004	0.55	0.312	0.02	0.312	PTB312-2250-500-J1S
	-0.002	3	0.005	0.55	0.375	0.03	0.5	PTB375-2250-500-J1S
	-0.002	3	0.005	0.688	0.375	0.03	0.5	PTB375-2250-625-J1S
2.375	-0.001	2.625	0.002	0.206	0.125	0.015	0.25	PTB125-2375-187-J1S
	-0.001	2.75	0.002	0.275	0.187	0.015	0.25	PTB187-2375-250-J1S
	-0.001	2.75	0.002	0.293	0.187	0.015	0.25	PTB187-2375-266-J1S
	-0.001	2.75	0.002	0.413	0.187	0.015	0.25	PTB187-2375-375-J1S
	-0.001	2.75	0.002	0.55	0.187	0.015	0.25	PTB187-2375-500-J1S
	-0.002	2.875	0.003	0.413	0.25	0.02	0.312	PTB250-2375-375-J1S
	-0.002	3	0.004	0.55	0.312	0.02	0.312	PTB312-2375-500-J1S
	-0.002	3.125	0.005	0.55	0.375	0.03	0.5	PTB375-2375-500-J1S
	-0.002	3.125	0.005	0.688	0.375	0.03	0.5	PTB375-2375-625-J1S
2.437	-0.002	3	0.003	0.413	0.281	0.02	0.312	PTB281-2437-375-J1S
2.5	-0.001	2.75	0.002	0.275	0.125	0.015	0.25	PTB125-2500-250-J1S
	-0.001	2.875	0.002	0.275	0.187	0.015	0.25	PTB187-2500-250-J1S
	-0.001	2.875	0.002	0.293	0.187	0.015	0.25	PTB187-2500-266-J1S
	-0.001	2.875	0.002	0.343	0.187	0.015	0.25	PTB187-2500-312-J1S
	-0.001	2.875	0.002	0.413	0.187	0.015	0.25	PTB187-2500-375-J1S
	-0.002	2.937	0.003	0.309	0.218	0.02	0.312	PTB218-2500-281-J1S
	-0.002	3	0.003	0.343	0.25	0.02	0.312	PTB250-2500-312-J1S
	-0.002	3	0.003	0.413	0.25	0.02	0.312	PTB250-2500-375-J1S
	-0.002	3	0.003	0.55	0.25	0.02	0.312	PTB250-2500-500-J1S
	-0.002	3.125	0.004	0.413	0.312	0.02	0.312	PTB312-2500-375-J1S
	-0.002	3.125	0.004	0.55	0.312	0.02	0.312	PTB312-2500-500-J1S
	-0.002	3.25	0.005	0.55	0.375	0.03	0.5	PTB375-2500-500-J1S
	-0.002	3.25	0.005	0.688	0.375	0.03	0.5	PTB375-2500-625-J1S
	-0.003	3.5	0.007	0.825	0.5	0.03	0.5	PTB500-2500-750-J1S

3.4

3.4 PTB profile rod seals, inch sizes d 2.625 – 3.75 in.

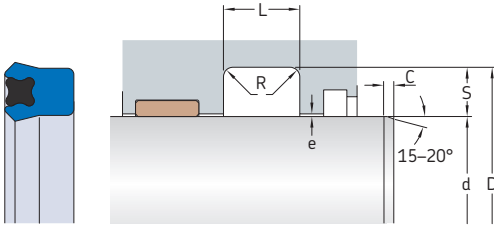

Maximum extrusion gap e

Radial depth S	e _{max} at 60 °C (140 °F) for pressures		
	2 300 psi	3 600 psi	5 800 psi
in.	in.		
0.125	0.008	0.004	–
0.156 to 0.187	0.014	0.008	–
0.218 to 0.25	0.018	0.01	0.004
0.281 to 0.437	0.02	0.012	0.006
0.5 to 0.562	0.024	0.012	0.008
0.625 to 0.75	0.024	0.012	0.008

For additional information → page 34

Dimensions

Designation

d	Tolerance	D	Tolerance	L +0.01	S	R max.	C min.	Designation
in.								–
2.625	-0.001	3	0.002	0.275	0.187	0.015	0.25	PTB187-2625-250-J15
	-0.001	3	0.002	0.293	0.187	0.015	0.25	PTB187-2625-266-J15
	-0.001	3	0.002	0.309	0.187	0.015	0.25	PTB187-2625-281-J15
	-0.001	3	0.002	0.413	0.187	0.015	0.25	PTB187-2625-375-J15
	-0.002	3.125	0.003	0.413	0.25	0.02	0.312	PTB250-2625-375-J15
	-0.002	3.375	0.005	0.688	0.375	0.03	0.5	PTB375-2625-625-J15
2.75	-0.001	3	0.002	0.275	0.125	0.015	0.25	PTB125-2750-250-J15
	-0.001	3	0.002	0.413	0.125	0.015	0.25	PTB125-2750-375-J15
	-0.001	3.125	0.002	0.309	0.187	0.015	0.25	PTB187-2750-281-J15
	-0.001	3.125	0.002	0.413	0.187	0.015	0.25	PTB187-2750-375-J15
	-0.002	3.25	0.003	0.413	0.25	0.02	0.312	PTB250-2750-375-J15
	-0.002	3.25	0.003	0.55	0.25	0.02	0.312	PTB250-2750-500-J15
	-0.002	3.375	0.004	0.55	0.312	0.02	0.312	PTB312-2750-500-J15
	-0.002	3.5	0.005	0.55	0.375	0.03	0.5	PTB375-2750-500-J15
	-0.002	3.5	0.005	0.688	0.375	0.03	0.5	PTB375-2750-625-J15
	-0.003	3.75	0.007	0.825	0.5	0.03	0.625	PTB500-2750-750-J15
2.875	-0.001	3.25	0.002	0.275	0.187	0.015	0.25	PTB187-2875-250-J15
	-0.001	3.25	0.002	0.293	0.187	0.015	0.25	PTB187-2875-266-J15
	-0.001	3.25	0.002	0.413	0.187	0.015	0.25	PTB187-2875-375-J15
	-0.002	3.375	0.003	0.413	0.25	0.02	0.312	PTB250-2875-375-J15
	-0.002	3.5	0.004	0.55	0.312	0.02	0.312	PTB312-2875-500-J15
	-0.002	3.625	0.005	0.55	0.375	0.03	0.5	PTB375-2875-500-J15
	-0.002	3.625	0.005	0.688	0.375	0.03	0.5	PTB375-2875-625-J15
3	-0.001	3.25	0.002	0.413	0.125	0.015	0.25	PTB125-3000-375-J15
	-0.001	3.375	0.002	0.343	0.187	0.015	0.25	PTB187-3000-312-J15
	-0.001	3.375	0.002	0.413	0.187	0.015	0.25	PTB187-3000-375-J15
	-0.002	3.5	0.003	0.413	0.25	0.02	0.312	PTB250-3000-375-J15
	-0.002	3.5	0.003	0.55	0.25	0.02	0.312	PTB250-3000-500-J15
	-0.002	3.625	0.004	0.413	0.312	0.02	0.312	PTB312-3000-375-J15
	-0.002	3.625	0.004	0.55	0.312	0.02	0.312	PTB312-3000-500-J15
	-0.002	3.75	0.005	0.55	0.375	0.03	0.5	PTB375-3000-500-J15
	-0.002	3.75	0.005	0.688	0.375	0.03	0.5	PTB375-3000-625-J15
	-0.002	3.875	0.004	0.759	0.437	0.03	0.5	PTB437-3000-690-J15

Dimensions								Designation
d	Tolerance	D	Tolerance	L +0.01	S	R max.	C min.	
in.								-
3	-0.003	4	0.007	0.688	0.5	0.03	0.625	PTB500-3000-625-J15
	cont. -0.003	4	0.007	0.825	0.5	0.03	0.625	PTB500-3000-750-J15
3.125	-0.001	3.5	0.002	0.275	0.187	0.015	0.25	PTB187-3125-250-J15
	-0.001	3.5	0.002	0.343	0.187	0.015	0.25	PTB187-3125-312-J15
	-0.001	3.5	0.002	0.413	0.187	0.015	0.25	PTB187-3125-375-J15
	-0.002	3.625	0.003	0.413	0.25	0.02	0.312	PTB250-3125-375-J15
	-0.002	3.75	0.004	0.55	0.312	0.02	0.312	PTB312-3125-500-J15
	-0.002	3.875	0.005	0.688	0.375	0.03	0.5	PTB375-3125-625-J15
3.187	-0.002	3.75	0.003	0.55	0.281	0.02	0.312	PTB281-3187-500-J15
3.25	-0.001	3.625	0.002	0.413	0.187	0.015	0.25	PTB187-3250-375-J15
	-0.002	3.75	0.003	0.413	0.25	0.02	0.312	PTB250-3250-375-J15
	-0.002	3.75	0.003	0.55	0.25	0.02	0.312	PTB250-3250-500-J15
	-0.002	3.875	0.004	0.55	0.312	0.02	0.312	PTB312-3250-500-J15
	-0.002	4	0.005	0.55	0.375	0.03	0.5	PTB375-3250-500-J15
	-0.002	4	0.005	0.618	0.375	0.03	0.5	PTB375-3250-562-J15
	-0.002	4	0.005	0.688	0.375	0.03	0.5	PTB375-3250-625-J15
	-0.003	4.25	0.007	0.825	0.5	0.03	0.625	PTB500-3250-750-J15
	-0.003	4.5	0.009	1.1	0.625	0.045	0.875	PTB625-3250-1000-J15
	3.375	-0.001	3.75	0.002	0.275	0.187	0.015	0.25
-0.001		3.75	0.002	0.413	0.187	0.015	0.25	PTB187-3375-375-J15
-0.002		3.875	0.003	0.413	0.25	0.02	0.312	PTB250-3375-375-J15
-0.002		4	0.004	0.55	0.312	0.02	0.312	PTB312-3375-500-J15
-0.002		4	0.004	0.688	0.312	0.02	0.312	PTB312-3375-625-J15
-0.002		4.125	0.005	0.688	0.375	0.03	0.5	PTB375-3375-625-J15
-0.003	4.375	0.007	0.688	0.5	0.03	0.625	PTB500-3375-625-J15	
3.437	-0.002	4	0.003	0.55	0.281	0.02	0.312	PTB281-3437-500-J15
3.5	-0.002	4	0.003	0.413	0.25	0.02	0.312	PTB250-3500-375-J15
	-0.002	4	0.003	0.55	0.25	0.02	0.312	PTB250-3500-500-J15
	-0.002	4.125	0.004	0.55	0.312	0.02	0.312	PTB312-3500-500-J15
	-0.002	4.25	0.005	0.688	0.375	0.03	0.5	PTB375-3500-625-J15
	-0.003	4.5	0.007	0.825	0.5	0.03	0.625	PTB500-3500-750-J15
	-0.003	4.5	0.007	0.825	0.5	0.03	0.625	PTB500-3500-750-J15
3.625	-0.001	3.875	0.002	0.206	0.125	0.015	0.25	PTB125-3625-187-J15
	-0.001	4	0.002	0.275	0.187	0.015	0.25	PTB187-3625-250-J15
	-0.001	4	0.002	0.413	0.187	0.015	0.25	PTB187-3625-375-J15
	-0.002	4.125	0.003	0.413	0.25	0.02	0.312	PTB250-3625-375-J15
	-0.002	4.25	0.004	0.413	0.312	0.02	0.312	PTB312-3625-375-J15
	-0.002	4.25	0.004	0.55	0.312	0.02	0.312	PTB312-3625-500-J15
	-0.002	4.375	0.005	0.55	0.375	0.03	0.5	PTB375-3625-500-J15
	-0.002	4.375	0.005	0.688	0.375	0.03	0.5	PTB375-3625-625-J15
3.75	-0.001	4	0.002	0.275	0.125	0.015	0.25	PTB125-3750-250-J15
	-0.001	4.125	0.002	0.413	0.187	0.015	0.25	PTB187-3750-375-J15
	-0.002	4.25	0.003	0.413	0.25	0.02	0.312	PTB250-3750-375-J15
	-0.002	4.25	0.003	0.55	0.25	0.02	0.312	PTB250-3750-500-J15
	-0.002	4.25	0.003	0.618	0.25	0.02	0.312	PTB250-3750-562-J15
	-0.002	4.375	0.004	0.413	0.312	0.02	0.312	PTB312-3750-375-J15
	-0.002	4.375	0.004	0.55	0.312	0.02	0.312	PTB312-3750-500-J15
	-0.002	4.375	0.004	0.688	0.312	0.02	0.312	PTB312-3750-625-J15
	-0.002	4.5	0.005	0.688	0.375	0.03	0.5	PTB375-3750-625-J15
	-0.003	4.75	0.007	0.759	0.5	0.03	0.625	PTB500-3750-690-J15
	-0.003	5	0.009	1.1	0.625	0.045	0.875	PTB625-3750-1000-J15

3.4

3.4 PTB profile rod seals, inch sizes d 3.875 – 5.25 in.

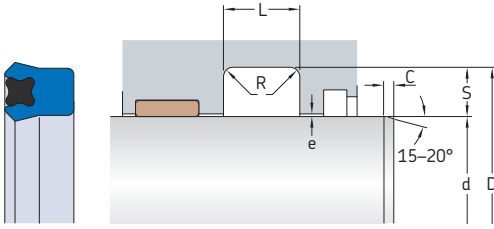

Maximum extrusion gap e

Radial depth S	e _{max} at 60 °C (140 °F) for pressures		
	2 300 psi	3 600 psi	5 800 psi
in.	in.		
0.125	0.008	0.004	–
0.156 to 0.187	0.014	0.008	–
0.218 to 0.25	0.018	0.01	0.004
0.281 to 0.437	0.02	0.012	0.006
0.5 to 0.562	0.024	0.012	0.008
0.625 to 0.75	0.024	0.012	0.008

For additional information → page 34

Dimensions

Designation

d	Tolerance	D	Tolerance	L +0.01	S	R max.	C min.	Designation
in.								–
3.875	–0.001	4.25	0.002	0.413	0.187	0.015	0.25	PTB187-3875-375-J15
	–0.002	4.375	0.003	0.413	0.25	0.02	0.312	PTB250-3875-375-J15
	–0.002	4.5	0.004	0.55	0.312	0.02	0.312	PTB312-3875-500-J15
	–0.002	4.625	0.005	0.688	0.375	0.03	0.5	PTB375-3875-625-J15
	–0.002	4.75	0.004	0.825	0.437	0.03	0.5	PTB437-3875-750-J15
4	–0.001	4.375	0.002	0.413	0.187	0.015	0.25	PTB187-4000-375-J15
	–0.002	4.5	0.003	0.343	0.25	0.02	0.312	PTB250-4000-312-J15
	–0.002	4.5	0.003	0.413	0.25	0.02	0.312	PTB250-4000-375-J15
	–0.002	4.5	0.003	0.55	0.25	0.02	0.312	PTB250-4000-500-J15
	–0.002	4.5	0.003	0.618	0.25	0.02	0.312	PTB250-4000-562-J15
	–0.002	4.625	0.004	0.618	0.312	0.02	0.312	PTB312-4000-562-J15
	–0.002	4.75	0.005	0.55	0.375	0.03	0.5	PTB375-4000-500-J15
	–0.002	4.75	0.005	0.688	0.375	0.03	0.5	PTB375-4000-625-J15
	–0.002	4.875	0.004	0.825	0.437	0.03	0.5	PTB437-4000-750-J15
	–0.003	5	0.007	0.688	0.5	0.03	0.625	PTB500-4000-625-J15
–0.003	5	0.007	0.825	0.5	0.03	0.625	PTB500-4000-750-J15	
–0.003	5.124	0.007	0.825	0.562	0.03	0.75	PTB562-4000-750-J15	
4.125	–0.001	4.5	0.002	0.413	0.187	0.015	0.25	PTB187-4125-375-J15
	–0.002	4.625	0.003	0.413	0.25	0.02	0.312	PTB250-4125-375-J15
	–0.002	4.625	0.003	0.618	0.25	0.02	0.312	PTB250-4125-562-J15
	–0.002	4.75	0.004	0.55	0.312	0.02	0.312	PTB312-4125-500-J15
	–0.002	4.75	0.004	0.618	0.312	0.02	0.312	PTB312-4125-562-J15
4.25	–0.001	4.625	0.002	0.413	0.187	0.015	0.25	PTB187-4250-375-J15
	–0.002	4.75	0.003	0.413	0.25	0.02	0.312	PTB250-4250-375-J15
	–0.002	4.75	0.003	0.618	0.25	0.02	0.312	PTB250-4250-562-J15
	–0.002	4.875	0.004	0.481	0.312	0.02	0.312	PTB312-4250-437-J15
	–0.002	4.875	0.004	0.618	0.312	0.02	0.312	PTB312-4250-562-J15
	–0.002	5	0.005	0.55	0.375	0.03	0.5	PTB375-4250-500-J15
	–0.002	5	0.005	0.688	0.375	0.03	0.5	PTB375-4250-625-J15
	–0.003	5.25	0.007	0.825	0.5	0.03	0.625	PTB500-4250-750-J15
	–0.003	5.5	0.009	1.1	0.625	0.045	0.875	PTB625-4250-1000-J15
	–0.003	5.5	0.009	0.825	0.625	0.045	0.875	PTB625-4250-750-J15

Dimensions								Designation	
d	Tolerance	D	Tolerance	L +0.01	S	R max.	C min.		
in.								-	
4.375	-0.001	4.75	0.002	0.413	0.187	0.015	0.25	PTB187-4375-375-J15	
	-0.002	4.875	0.003	0.618	0.25	0.02	0.312	PTB250-4375-562-J15	
	-0.002	5	0.004	0.55	0.312	0.02	0.312	PTB312-4375-500-J15	
	-0.002	5	0.004	0.618	0.312	0.02	0.312	PTB312-4375-562-J15	
	-0.002	5.125	0.005	0.55	0.375	0.03	0.5	PTB375-4375-500-J15	
	-0.002	5.125	0.005	0.688	0.375	0.03	0.5	PTB375-4375-625-J15	
	-0.003	5.375	0.007	0.825	0.5	0.03	0.625	PTB500-4375-750-J15	
4.5	-0.001	4.75	0.002	0.206	0.125	0.015	0.25	PTB125-4500-187-J15	
	-0.001	4.875	0.002	0.343	0.187	0.015	0.25	PTB187-4500-312-J15	
	-0.001	4.875	0.002	0.413	0.187	0.015	0.25	PTB187-4500-312-J15	
	-0.002	5	0.003	0.343	0.25	0.02	0.312	PTB250-4500-312-J15	
	-0.002	5	0.003	0.413	0.25	0.02	0.312	PTB250-4500-312-J15	
	-0.002	5	0.003	0.55	0.25	0.02	0.312	PTB250-4500-500-J15	
	-0.002	5	0.003	0.618	0.25	0.02	0.312	PTB250-4500-562-J15	
	-0.002	5	0.003	0.688	0.25	0.02	0.312	PTB250-4500-625-J15	
	-0.002	5.125	0.004	0.55	0.312	0.02	0.312	PTB312-4500-500-J15	
	-0.002	5.125	0.004	0.688	0.312	0.02	0.312	PTB312-4500-625-J15	
	-0.002	5.25	0.005	0.688	0.375	0.03	0.5	PTB375-4500-625-J15	
	-0.002	5.375	0.006	0.825	0.437	0.03	0.5	PTB437-4500-750-J15	
4.625	-0.002	5.125	0.003	0.618	0.25	0.02	0.312	PTB250-4625-562-J15	
	-0.002	5.25	0.004	0.688	0.312	0.02	0.312	PTB312-4625-625-J15	
	-0.002	5.375	0.005	0.688	0.375	0.03	0.5	PTB375-4625-625-J15	
4.75	-0.001	5	0.002	0.275	0.125	0.015	0.25	PTB125-4750-250-J15	
	-0.001	5.125	0.002	0.413	0.187	0.015	0.25	PTB187-4750-375-J15	
	-0.002	5.25	0.003	0.413	0.25	0.02	0.312	PTB250-4750-375-J15	
	-0.002	5.25	0.003	0.618	0.25	0.02	0.312	PTB250-4750-562-J15	
	-0.002	5.375	0.004	0.55	0.312	0.02	0.312	PTB312-4750-500-J15	
	-0.002	5.375	0.004	0.688	0.312	0.02	0.312	PTB312-4750-625-J15	
	-0.002	5.5	0.005	0.55	0.375	0.03	0.5	PTB375-4750-500-J15	
	-0.002	5.5	0.005	0.688	0.375	0.03	0.5	PTB375-4750-625-J15	
	-0.002	5.625	0.006	0.825	0.437	0.03	0.5	PTB437-4750-750-J15	
	-0.003	5.75	0.007	0.759	0.5	0.03	0.625	PTB500-4750-690-J15	
	4.875	-0.002	5.375	0.003	0.618	0.25	0.02	0.312	PTB250-4875-562-J15
		-0.002	5.375	0.003	0.688	0.25	0.02	0.312	PTB250-4875-625-J15
-0.002		5.625	0.005	0.688	0.375	0.03	0.5	PTB375-4875-625-J15	
5	-0.001	5.25	0.002	0.275	0.125	0.015	0.25	PTB125-5000-250-J15	
	-0.001	5.375	0.002	0.413	0.187	0.015	0.25	PTB187-5000-375-J15	
	-0.002	5.5	0.003	0.413	0.25	0.02	0.312	PTB250-5000-375-J15	
	-0.002	5.5	0.003	0.55	0.25	0.02	0.312	PTB250-5000-500-J15	
	-0.002	5.5	0.003	0.618	0.25	0.02	0.312	PTB250-5000-562-J15	
	-0.002	5.625	0.004	0.688	0.312	0.02	0.312	PTB312-5000-625-J15	
	-0.002	5.75	0.005	0.55	0.375	0.03	0.5	PTB375-5000-500-J15	
	-0.002	5.75	0.005	0.688	0.375	0.03	0.5	PTB375-5000-625-J15	
	-0.003	6	0.007	0.688	0.5	0.03	0.625	PTB500-5000-625-J15	
	-0.003	6	0.007	0.825	0.5	0.03	0.625	PTB500-5000-750-J15	
	-0.003	6.25	0.009	1.1	0.625	0.045	0.875	PTB625-5000-1000-J15	
	5.125	-0.002	5.875	0.005	0.688	0.375	0.03	0.5	PTB375-5125-625-J15
5.25	-0.001	5.625	0.002	0.413	0.187	0.015	0.25	PTB187-5250-375-J15	
	-0.002	5.75	0.003	0.413	0.25	0.02	0.312	PTB250-5250-375-J15	
	-0.002	5.75	0.003	0.618	0.25	0.02	0.312	PTB250-5250-562-J15	
	-0.002	5.875	0.004	0.688	0.312	0.02	0.312	PTB312-5250-625-J15	

3.4

3.4 PTB profile rod seals, inch sizes d 5.25 – 7.5 in.

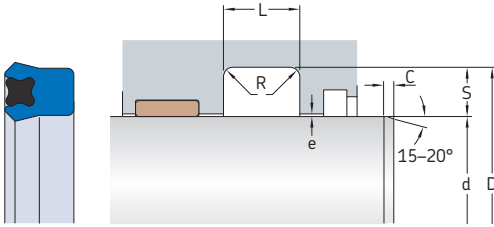

Maximum extrusion gap e

Radial depth S	e _{max} at 60 °C (140 °F) for pressures		
	2 300 psi	3 600 psi	5 800 psi
in.	in.		
0.125	0.008	0.004	–
0.156 to 0.187	0.014	0.008	–
0.218 to 0.25	0.018	0.01	0.004
0.281 to 0.437	0.02	0.012	0.006
0.5 to 0.562	0.024	0.012	0.008
0.625 to 0.75	0.024	0.012	0.008

For additional information → page 34

Dimensions

Designation

d	Tolerance	D	Tolerance	L +0.01	S	R max.	C min.	Designation
in.								–
5.25	–0.002	6	0.005	0.55	0.375	0.03	0.5	PTB375-5250-500-J1S
cont.	–0.002	6	0.005	0.688	0.375	0.03	0.5	PTB375-5250-625-J1S
	–0.003	6.25	0.007	0.825	0.5	0.03	0.625	PTB500-5250-750-J1S
	–0.003	6.5	0.009	1.1	0.625	0.045	0.875	PTB625-5250-1000-J1S
5.375	–0.002	5.875	0.003	0.618	0.25	0.02	0.312	PTB250-5375-562-J1S
	–0.002	6	0.004	0.688	0.312	0.02	0.312	PTB312-5375-625-J1S
	–0.002	6.125	0.005	0.688	0.375	0.03	0.5	PTB375-5375-625-J1S
	–0.003	6.375	0.007	0.825	0.5	0.03	0.625	PTB500-5375-750-J1S
5.437	–0.002	5.875	0.003	0.618	0.218	0.02	0.312	PTB218-5437-562-J1S
	–0.002	6	0.003	0.618	0.281	0.02	0.312	PTB281-5437-562-J1S
5.5	–0.001	5.875	0.002	0.413	0.187	0.015	0.25	PTB187-5500-375-J1S
	–0.002	6	0.003	0.413	0.25	0.02	0.312	PTB250-5500-375-J1S
	–0.002	6	0.003	0.618	0.25	0.02	0.312	PTB250-5500-562-J1S
	–0.002	6.125	0.004	0.413	0.312	0.02	0.312	PTB312-5500-375-J1S
	–0.002	6.125	0.004	0.688	0.312	0.02	0.312	PTB312-5500-625-J1S
	–0.002	6.25	0.005	0.55	0.375	0.03	0.5	PTB375-5500-500-J1S
	–0.002	6.25	0.005	0.688	0.375	0.03	0.5	PTB375-5500-625-J1S
	–0.002	6.375	0.006	0.55	0.437	0.03	0.5	PTB437-5500-500-J1S
	–0.003	6.5	0.007	0.688	0.5	0.03	0.625	PTB500-5500-625-J1S
	–0.003	6.5	0.007	0.825	0.5	0.03	0.625	PTB500-5500-750-J1S
5.625	–0.001	6	0.002	0.413	0.187	0.015	0.25	PTB187-5625-375-J1S
5.625	–0.002	6.25	0.004	0.688	0.312	0.02	0.312	PTB312-5625-625-J1S
5.75	–0.001	6.125	0.002	0.413	0.187	0.015	0.25	PTB187-5750-375-J1S
	–0.002	6.25	0.003	0.413	0.25	0.02	0.312	PTB250-5750-375-J1S
	–0.002	6.25	0.003	0.618	0.25	0.02	0.312	PTB250-5750-562-J1S
	–0.002	6.375	0.004	0.688	0.312	0.02	0.312	PTB312-5750-625-J1S
	–0.002	6.5	0.005	0.688	0.375	0.03	0.5	PTB375-5750-625-J1S
	–0.003	6.75	0.007	0.825	0.5	0.03	0.625	PTB500-5750-750-J1S
	–0.003	7	0.009	1.1	0.625	0.045	0.875	PTB625-5750-1000-J1S
5.875	–0.002	6.375	0.003	0.618	0.25	0.02	0.312	PTB250-5875-562-J1S
	–0.002	6.5	0.004	0.413	0.312	0.02	0.312	PTB312-5875-375-J1S
	–0.002	6.625	0.005	0.688	0.375	0.03	0.5	PTB375-5875-625-J1S
	–0.003	6.875	0.007	0.825	0.5	0.03	0.625	PTB500-5875-750-J1S

Dimensions								Designation
d	Tolerance	D	Tolerance	L +0.01	S	R max.	C min.	
in.								-
6	-0.001	6.375	0.002	0.413	0.187	0.015	0.25	PTB187-6000-375-J1S
	-0.002	6.5	0.003	0.413	0.25	0.02	0.312	PTB250-6000-375-J1S
	-0.002	6.5	0.003	0.481	0.25	0.02	0.312	PTB250-6000-437-J1S
	-0.002	6.5	0.003	0.618	0.25	0.02	0.312	PTB250-6000-562-J1S
	-0.002	6.625	0.004	0.688	0.312	0.02	0.312	PTB312-6000-625-J1S
	-0.002	6.75	0.005	0.55	0.375	0.03	0.5	PTB375-6000-500-J1S
	-0.002	6.75	0.005	0.618	0.375	0.03	0.5	PTB375-6000-562-J1S
	-0.002	6.75	0.005	0.688	0.375	0.03	0.5	PTB375-6000-625-J1S
	-0.003	7	0.007	0.825	0.5	0.03	0.625	PTB500-6000-750-J1S
	-0.002	6.625	0.003	0.413	0.25	0.02	0.312	PTB250-6125-375-J1S
6.125	-0.001	6.625	0.002	0.343	0.187	0.015	0.25	PTB187-6250-312-J1S
	-0.002	6.75	0.003	0.413	0.25	0.02	0.312	PTB250-6250-375-J1S
	-0.002	7	0.005	0.55	0.375	0.03	0.5	PTB375-6250-500-J1S
	-0.002	7	0.005	0.688	0.375	0.03	0.5	PTB375-6250-625-J1S
	-0.003	7.25	0.007	0.825	0.5	0.03	0.625	PTB500-6250-750-J1S
	-0.003	7.5	0.009	1.1	0.625	0.045	0.875	PTB625-6250-1000-J1S
6.375	-0.002	7	0.004	0.688	0.312	0.02	0.312	PTB312-6375-625-J1S
6.5	-0.002	7	0.003	0.413	0.25	0.02	0.312	PTB250-6500-375-J1S
	-0.002	7	0.003	0.618	0.25	0.02	0.312	PTB250-6500-562-J1S
	-0.002	7.125	0.004	0.688	0.312	0.02	0.312	PTB312-6500-625-J1S
	-0.002	7.25	0.005	0.55	0.375	0.03	0.5	PTB375-6500-500-J1S
	-0.002	7.25	0.005	0.688	0.375	0.03	0.5	PTB375-6500-625-J1S
	-0.003	7.5	0.007	0.825	0.5	0.03	0.625	PTB500-6500-750-J1S
6.625	-0.002	7.25	0.004	0.688	0.312	0.02	0.312	PTB312-6625-625-J1S
6.75	-0.002	7.25	0.003	0.413	0.25	0.02	0.312	PTB250-6750-375-J1S
	-0.002	7.25	0.003	0.618	0.25	0.02	0.312	PTB250-6750-562-J1S
	-0.002	7.5	0.005	0.55	0.375	0.03	0.5	PTB375-6750-500-J1S
	-0.002	7.5	0.005	0.688	0.375	0.03	0.5	PTB375-6750-625-J1S
	-0.003	7.75	0.007	0.825	0.5	0.03	0.625	PTB500-6750-750-J1S
6.875	-0.002	7.625	0.005	0.688	0.375	0.03	0.5	PTB375-6875-625-J1S
7	-0.002	7.5	0.003	0.413	0.25	0.02	0.312	PTB250-7000-375-J1S
	-0.002	7.5	0.003	0.618	0.25	0.02	0.312	PTB250-7000-562-J1S
	-0.002	7.625	0.004	0.688	0.312	0.02	0.312	PTB312-7000-625-J1S
	-0.002	7.75	0.005	0.55	0.375	0.03	0.5	PTB375-7000-500-J1S
	-0.002	7.75	0.005	0.688	0.375	0.03	0.5	PTB375-7000-625-J1S
	-0.003	8	0.007	0.825	0.5	0.03	0.625	PTB500-7000-750-J1S
	-0.003	8.25	0.009	1.1	0.625	0.045	0.875	PTB625-7000-1000-J1S
	-0.003	8.25	0.009	0.825	0.625	0.045	0.875	PTB625-7000-750-J1S
7.125	-0.002	7.625	0.003	0.618	0.25	0.02	0.312	PTB250-7125-562-J1S
7.25	-0.002	7.75	0.003	0.618	0.25	0.02	0.312	PTB250-7250-562-J1S
	-0.002	7.875	0.004	0.688	0.312	0.02	0.312	PTB312-7250-625-J1S
	-0.002	8	0.005	0.688	0.375	0.03	0.5	PTB375-7250-625-J1S
	-0.003	8.25	0.007	0.825	0.5	0.03	0.625	PTB500-7250-750-J1S
7.375	-0.002	8	0.004	0.688	0.312	0.02	0.312	PTB312-7375-625-J1S
7.5	-0.001	7.875	0.002	0.343	0.187	0.015	0.25	PTB187-7500-312-J1S
	-0.002	8	0.003	0.413	0.25	0.02	0.312	PTB250-7500-375-J1S
	-0.002	8	0.003	0.618	0.25	0.02	0.312	PTB250-7500-562-J1S
	-0.002	8.25	0.005	0.55	0.375	0.03	0.5	PTB375-7500-500-J1S
	-0.002	8.25	0.005	0.688	0.375	0.03	0.5	PTB375-7500-625-J1S
	-0.002	8.375	0.006	0.55	0.437	0.03	0.5	PTB437-7500-500-J1S
	-0.003	8.75	0.009	1.1	0.625	0.045	0.875	PTB625-7500-1000-J1S

3.4

3.4 PTB profile rod seals, inch sizes d 7.75 – 14.375 in.

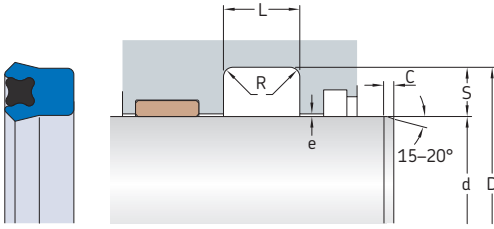

Maximum extrusion gap e

Radial depth S	e _{max} at 60 °C (140 °F) for pressures		
	2300 psi	3 600 psi	5 800 psi
in.	in.		
0.125	0.008	0.004	–
0.156 to 0.187	0.014	0.008	–
0.218 to 0.25	0.018	0.01	0.004
0.281 to 0.437	0.02	0.012	0.006
0.5 to 0.562	0.024	0.012	0.008
0.625 to 0.75	0.024	0.012	0.008

For additional information → page 34

Dimensions

Designation

d	Tolerance	D	Tolerance	L	S	R	C	Designation
				+0.01		max.	min.	
in.								–
7.75	-0.002	8.25	0.003	0.618	0.25	0.02	0.312	PTB250-7750-562-J15
	-0.002	8.5	0.005	0.55	0.375	0.03	0.5	PTB375-7750-500-J15
	-0.002	8.5	0.005	0.688	0.375	0.03	0.5	PTB375-7750-625-J15
	-0.003	8.75	0.007	0.825	0.5	0.03	0.625	PTB500-7750-750-J15
8	-0.002	8.5	0.003	0.618	0.25	0.02	0.312	PTB250-8000-562-J15
	-0.002	8.625	0.004	0.688	0.312	0.02	0.312	PTB312-8000-625-J15
	-0.002	8.75	0.005	0.688	0.375	0.03	0.5	PTB375-8000-625-J15
	-0.003	9	0.007	0.825	0.5	0.03	0.625	PTB500-8000-750-J15
	-0.003	9.5	0.011	1.375	0.75	0.045	1	PTB750-8000-1250-J15
8.125	-0.002	8.625	0.003	0.618	0.25	0.02	0.312	PTB250-8125-562-J15
8.25	-0.002	8.75	0.003	0.618	0.25	0.02	0.312	PTB250-8250-562-J15
	-0.002	9	0.005	0.688	0.375	0.03	0.5	PTB375-8250-625-J15
	-0.003	9.5	0.009	1.1	0.625	0.045	0.875	PTB625-8250-1000-J15
8.375	-0.002	8.875	0.003	0.618	0.25	0.02	0.312	PTB250-8375-562-J15
8.5	-0.002	9	0.003	0.618	0.25	0.02	0.312	PTB250-8500-562-J15
	-0.002	9.25	0.005	0.55	0.375	0.03	0.5	PTB375-8500-500-J15
	-0.002	9.25	0.005	0.688	0.375	0.03	0.5	PTB375-8500-625-J15
	-0.002	9.312	0.005	0.55	0.406	0.03	0.5	PTB406-8500-500-J15
8.75	-0.003	9.5	0.007	0.825	0.5	0.03	0.625	PTB500-8500-750-J15
	-0.003	9.75	0.009	1.1	0.625	0.045	0.875	PTB625-8500-1000-J15
	-0.003	10	0.011	1.238	0.75	0.045	1	PTB750-8500-1125-J15
8.75	-0.002	9.5	0.005	0.55	0.375	0.03	0.5	PTB375-8750-500-J15
9	-0.002	9.5	0.003	0.618	0.25	0.02	0.312	PTB250-9000-562-J15
	-0.002	9.75	0.005	0.688	0.375	0.03	0.5	PTB375-9000-625-J15
	-0.003	10	0.007	0.825	0.5	0.03	0.625	PTB500-9000-750-J15
	-0.003	10.5	0.011	1.375	0.75	0.045	1	PTB750-9000-1250-J15
9.25	-0.003	10.5	0.011	1.65	0.75	0.045	1	PTB750-9000-1500-J15
	-0.002	9.875	0.004	0.688	0.312	0.02	0.312	PTB312-9250-625-J15
	-0.002	10	0.005	0.688	0.375	0.03	0.5	PTB375-9250-625-J15
-0.003	10.25	0.007	0.825	0.5	0.03	0.625	PTB500-9250-750-J15	

Dimensions								Designation
d	Tolerance	D	Tolerance	L +0.01	S	R max.	C min.	
in.								-
9.5	-0.002	10	0.003	0.618	0.25	0.02	0.312	PTB250-9500-562-J1S
	-0.002	10.25	0.005	0.688	0.375	0.03	0.5	PTB375-9500-625-J1S
	-0.003	10.5	0.007	0.825	0.5	0.03	0.625	PTB500-9500-750-J1S
9.625	-0.002	10.125	0.003	0.413	0.25	0.02	0.312	PTB250-9625-375-J1S
9.75	-0.002	10.5	0.005	0.688	0.375	0.03	0.5	PTB375-9750-625-J1S
	-0.003	10.75	0.007	0.825	0.5	0.03	0.625	PTB500-9750-750-J1S
10	-0.002	10.5	0.003	0.618	0.25	0.02	0.312	PTB250-10000-562-J1S
	-0.002	10.75	0.005	0.688	0.375	0.03	0.5	PTB375-10000-625-J1S
	-0.003	11	0.007	0.825	0.5	0.03	0.625	PTB500-10000-750-J1S
	-0.003	11.25	0.009	1.1	0.625	0.045	0.875	PTB625-10000-1000-J1S
10.25	-0.003	11.5	0.011	1.375	0.75	0.045	1	PTB750-10000-1250-J1S
	-0.002	11	0.005	0.55	0.375	0.03	0.5	PTB375-10250-500-J1S
10.5	-0.002	11.25	0.005	0.688	0.375	0.03	0.5	PTB375-10500-625-J1S
	-0.003	11.5	0.007	1.1	0.5	0.03	0.625	PTB500-10500-1000-J1S
	-0.003	11.5	0.007	0.825	0.5	0.03	0.625	PTB500-10500-750-J1S
	-0.003	12	0.011	1.1	0.75	0.045	1	PTB750-10500-1000-J1S
10.625	-0.003	11.625	0.007	0.825	0.5	0.03	0.625	PTB500-10625-750-J1S
10.75	-0.002	11.5	0.005	0.688	0.375	0.03	0.5	PTB375-10750-625-J1S
	-0.003	11.75	0.007	0.825	0.5	0.03	0.625	PTB500-10750-750-J1S
11	-0.002	11.75	0.005	0.688	0.375	0.03	0.5	PTB375-11000-625-J1S
	-0.003	12	0.007	0.825	0.5	0.03	0.625	PTB500-11000-750-J1S
	-0.003	12.25	0.009	1.1	0.625	0.045	0.875	PTB625-11000-1000-J1S
11.25	-0.002	12	0.005	0.688	0.375	0.03	0.5	PTB375-11250-625-J1S
	-0.003	12.5	0.009	1.1	0.625	0.045	0.875	PTB625-11250-1000-J1S
11.5	-0.002	12	0.003	0.584	0.25	0.02	0.312	PTB250-11500-531-J1S
	-0.002	12.25	0.005	0.688	0.375	0.03	0.5	PTB375-11500-625-J1S
	-0.003	12.75	0.009	1.1	0.625	0.045	0.875	PTB625-11500-1000-J1S
11.75	-0.003	12.75	0.007	0.825	0.5	0.03	0.625	PTB500-11750-750-J1S
12	-0.002	12.5	0.003	0.618	0.25	0.02	0.312	PTB250-12000-562-J1S
	-0.003	13	0.007	0.825	0.5	0.03	0.625	PTB500-12000-750-J1S
	-0.003	13.5	0.011	1.375	0.75	0.045	1	PTB750-12000-1250-J1S
12.25	-0.003	13.5	0.009	1.1	0.625	0.045	0.875	PTB625-12250-1000-J1S
12.5	-0.002	13	0.003	0.584	0.25	0.02	0.312	PTB250-12500-531-J1S
	-0.003	13.5	0.007	0.825	0.5	0.03	0.625	PTB500-12500-750-J1S
12.75	-0.002	13.25	0.003	0.618	0.25	0.02	0.312	PTB250-12750-562-J1S
	-0.002	13.5	0.005	0.688	0.375	0.03	0.5	PTB375-12750-625-J1S
	-0.003	13.75	0.007	0.825	0.5	0.03	0.625	PTB500-12750-750-J1S
13	-0.003	14	0.007	0.825	0.5	0.03	0.625	PTB500-13000-750-J1S
13.5	-0.002	14	0.003	0.584	0.25	0.02	0.312	PTB250-13500-531-J1S
	-0.002	14	0.003	0.618	0.25	0.02	0.312	PTB250-13500-562-J1S
	-0.003	14.75	0.009	0.963	0.625	0.045	0.875	PTB625-13500-875-J1S
13.625	-0.002	14.375	0.005	0.688	0.375	0.03	0.5	PTB375-13625-625-J1S
14	-0.003	15	0.007	0.825	0.5	0.03	0.625	PTB500-14000-750-J1S
	-0.003	15.5	0.011	1.375	0.75	0.045	1	PTB750-14000-1250-J1S
14.25	-0.002	15	0.005	0.688	0.375	0.03	0.5	PTB375-14250-625-J1S
	-0.003	15.75	0.011	1.375	0.75	0.045	1	PTB750-14250-1250-J1S
14.375	-0.002	15.125	0.005	0.688	0.375	0.03	0.5	PTB375-14375-625-J1S

3.4

3.4 PTB profile rod seals, inch sizes d 14.5 – 35 in.

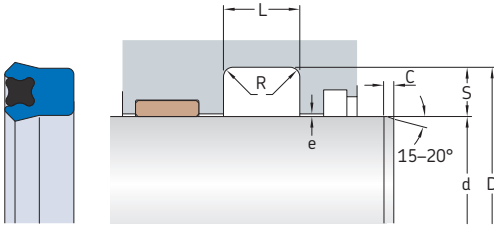

Maximum extrusion gap e

Radial depth	e _{max} at 60 °C (140 °F) for pressures		
	2 300 psi	3 600 psi	5 800 psi
S			
in.	in.		
0.125	0.008	0.004	–
0.156 to 0.187	0.014	0.008	–
0.218 to 0.25	0.018	0.01	0.004
0.281 to 0.437	0.02	0.012	0.006
0.5 to 0.562	0.024	0.012	0.008
0.625 to 0.75	0.024	0.012	0.008

For additional information → page 34

Dimensions

Designation

d	Tolerance	D	Tolerance	L +0.01	S	R max.	C min.	Designation
in.								–
14.5	-0.003	16	0.011	1.238	0.75	0.045	1	PTB750-14500-1125-J15
14.75	-0.002 -0.003	15.5 16	0.005 0.009	0.688 1.1	0.375 0.625	0.03 0.045	0.5 0.875	PTB375-14750-625-J15 PTB625-14750-1000-J15
15	-0.003	16	0.007	0.825	0.5	0.03	0.625	PTB500-15000-750-J15
15.25	-0.002	16	0.005	0.688	0.375	0.03	0.5	PTB375-15250-625-J15
15.5	-0.003	16.75	0.009	1.1	0.625	0.045	0.875	PTB625-15500-1000-J15
15.75	-0.003	16.75	0.007	0.825	0.5	0.03	0.625	PTB500-15750-750-J15
16	-0.003 -0.003 -0.003	17 17.25 17.5	0.007 0.009 0.011	0.825 1.238 1.375	0.5 0.625 0.75	0.03 0.045 0.045	0.625 0.875 1	PTB500-16000-750-J15 PTB625-16000-1125-J15 PTB750-16000-1250-J15
16.5	-0.003	17.5	0.007	0.825	0.5	0.03	0.625	PTB500-16500-750-J15
17	-0.003	18	0.007	0.825	0.5	0.03	0.625	PTB500-17000-750-J15
18	-0.003 -0.003	19 19.25	0.007 0.009	0.825 1.1	0.5 0.625	0.03 0.045	0.625 0.875	PTB500-18000-750-J15 PTB625-18000-1000-J15
18.5	-0.003	20	0.011	1.375	0.75	0.045	1	PTB750-18500-1250-J15
18.75	-0.003	20	0.009	1.1	0.625	0.045	0.875	PTB625-18750-1000-J15
19	-0.003	20	0.007	0.825	0.5	0.03	0.625	PTB500-19000-750-J15
20	-0.003	21.5	0.011	1.375	0.75	0.045	1	PTB750-20000-1250-J15
21	-0.003	22	0.007	0.825	0.5	0.03	0.625	PTB500-21000-750-J15
22.5	-0.003	24	0.011	1.1	0.75	0.045	1	PTB750-22500-1000-J15
23	-0.003	24	0.007	0.825	0.5	0.03	0.625	PTB500-23000-750-J15
24.5	-0.003	25.5	0.007	0.825	0.5	0.03	0.625	PTB500-24500-750-J15
25.5	-0.003	26.5	0.007	0.825	0.5	0.03	0.625	PTB500-25500-750-J15

Dimensions								Designation
d	Tolerance	D	Tolerance	L +0.01	S	R max.	C min.	
in.								-
30.75	-0.003	32	0.009	1.1	0.625	0.045	0.875	PTB625-30750-1000-J1S
35	-0.002	35.75	0.005	0.688	0.375	0.03	0.5	PTB375-35000-625-J1S

Other sizes are available on request

STD profile data



Material codes	Sealing ring: U-1003 X-ring: A-8501 For additional information → page 26
Pressure	Up to 400 bar (5 800 psi)
Speed	Up to 1 m/s (3.2 ft/s)
Temperature range	<div style="display: flex; align-items: center;">  </div> <p> ■ Extreme low temperature range: may be intermittently exposed (e.g. cold start-up) without seal damage, but seal performance may be compromised while in this range ■ Temperatures below the recommended operating range: seal performance depends on system design (precision guiding arrangement recommended) ■ Recommended operating temperature range for this profile and material ■ Temperatures above the recommended operating range: acceptable only with reduced pressure, speed, e-gap and/or with the use of a full-face anti-extrusion ring ■ Extreme high temperature range: only occasional short-term exposure (e.g. cylinder in curing oven of a powder coating process) </p>
Counter-surface	→ page 22

Maximum values of application parameters (e.g. pressure, speed, temperature, e-gap) should not be applied continuously nor simultaneously.

3.5 STD profile rod seals, inch sizes d 0.125 – 0.562 in.

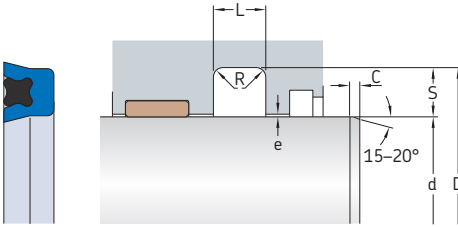

Maximum extrusion gap e

Radial depth S	e _{max} at 60 °C (140 °F) for pressures		
	2 300 psi	3 600 psi	5 800 psi
in.	in.		
0.125	0.008	0.004	–
0.156 to 0.187	0.014	0.008	–
0.218 to 0.25	0.018	0.01	0.004
0.281 to 0.437	0.02	0.012	0.006
0.5 to 0.562	0.024	0.012	0.008
0.625 to 0.75	0.024	0.012	0.008

For additional information → page 34

Dimensions

Designation

d	Tolerance	D	Tolerance	L +0.01	S	R max.	C min.	
in.								–
0.125	–0.001	0.375	0.002	0.138	0.125	0.015	0.25	STD125-125-125-J1S
0.14	–0.001	0.39	0.002	0.138	0.125	0.015	0.25	STD125-140-125-J1S
0.156	–0.001	0.406	0.002	0.138	0.125	0.015	0.25	STD125-156-125-J1S
0.187	–0.001 –0.001	0.437 0.561	0.002 0.002	0.138 0.206	0.125 0.187	0.015 0.015	0.25 0.25	STD125-187-125-J1S STD187-187-187-J1S
0.25	–0.001 –0.001 –0.002 –0.002	0.5 0.624 0.75 0.874	0.002 0.002 0.003 0.004	0.138 0.206 0.275 0.343	0.125 0.187 0.25 0.312	0.015 0.015 0.02 0.02	0.25 0.25 0.312 0.312	STD125-250-125-J1S STD187-250-187-J1S STD250-250-250-J1S STD312-250-312-J1S
0.312	–0.001 –0.001 –0.002 –0.002	0.562 0.686 0.748 0.812	0.002 0.002 0.003 0.003	0.138 0.206 0.24 0.275	0.125 0.187 0.218 0.25	0.015 0.015 0.015 0.02	0.25 0.25 0.25 0.312	STD125-312-125-J1S STD187-312-187-J1S STD218-312-218-J1S STD250-312-250-J1S
0.375	–0.001 –0.001 –0.002 –0.002	0.625 0.749 0.875 0.999	0.002 0.002 0.003 0.004	0.138 0.206 0.275 0.343	0.125 0.187 0.25 0.312	0.015 0.015 0.02 0.02	0.25 0.25 0.312 0.312	STD125-375-125-J1S STD187-375-187-J1S STD250-375-250-J1S STD312-375-312-J1S
0.437	–0.001 –0.001 –0.002 –0.002	0.687 0.811 0.937 1.061	0.002 0.002 0.003 0.004	0.138 0.206 0.275 0.343	0.125 0.187 0.25 0.312	0.015 0.015 0.02 0.02	0.25 0.25 0.312 0.312	STD125-437-125-J1S STD187-437-187-J1S STD250-437-250-J1S STD312-437-312-J1S
0.5	–0.001 –0.001 –0.001 –0.002 –0.002 –0.002	0.75 0.812 0.874 1 1.124 1.25	0.002 0.002 0.002 0.003 0.004 0.005	0.138 0.172 0.206 0.275 0.343 0.413	0.125 0.156 0.187 0.25 0.312 0.375	0.015 0.015 0.015 0.02 0.02 0.03	0.25 0.25 0.25 0.312 0.312 0.5	STD125-500-125-J1S STD156-500-156-J1S STD187-500-187-J1S STD250-500-250-J1S STD312-500-312-J1S STD375-500-375-J1S
0.562	–0.001 –0.001 –0.002	0.812 0.936 1.062	0.002 0.002 0.003	0.138 0.206 0.275	0.125 0.187 0.25	0.015 0.015 0.02	0.25 0.25 0.312	STD125-562-125-J1S STD187-562-187-J1S STD250-562-250-J1S

3.5 STD profile rod seals, inch sizes d 0.625 – 1.75 in.

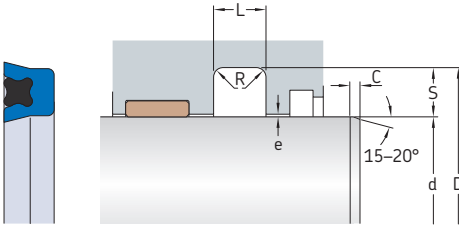

Maximum extrusion gap e

Radial depth S	e _{max} at 60 °C (140 °F) for pressures		
	2 300 psi	3 600 psi	5 800 psi
in.	in.		
0.125	0.008	0.004	–
0.156 to 0.187	0.014	0.008	–
0.218 to 0.25	0.018	0.01	0.004
0.281 to 0.437	0.02	0.012	0.006
0.5 to 0.562	0.024	0.012	0.008
0.625 to 0.75	0.024	0.012	0.008

For additional information → page 34

Dimensions

Designation

d	Tolerance	D	Tolerance	L +0.01	S	R max.	C min.	Designation
in.								–
0.625	–0.001	0.875	0.002	0.138	0.125	0.015	0.25	STD125-625-125-J1S
	–0.001	0.937	0.002	0.172	0.156	0.015	0.25	STD156-625-156-J1S
	–0.001	0.999	0.002	0.206	0.187	0.015	0.25	STD187-625-187-J1S
	–0.002	1.125	0.003	0.275	0.25	0.02	0.312	STD250-625-250-J1S
	–0.002	1.249	0.004	0.343	0.312	0.02	0.312	STD312-625-312-J1S
	–0.002	1.375	0.005	0.413	0.375	0.03	0.5	STD375-625-375-J1S
	–0.003	1.625	0.007	0.55	0.5	0.03	0.625	STD500-625-500-J1S
0.687	–0.001	0.937	0.002	0.138	0.125	0.015	0.25	STD125-687-125-J1S
0.75	–0.001	1	0.002	0.138	0.125	0.015	0.25	STD125-750-125-J1S
	–0.001	1.062	0.002	0.172	0.156	0.015	0.25	STD156-750-156-J1S
	–0.001	1.124	0.002	0.206	0.187	0.015	0.25	STD187-750-187-J1S
	–0.002	1.25	0.003	0.275	0.25	0.02	0.312	STD250-750-250-J1S
	–0.002	1.374	0.004	0.343	0.312	0.02	0.312	STD312-750-312-J1S
	–0.002	1.5	0.005	0.413	0.375	0.03	0.5	STD375-750-375-J1S
0.812	–0.001	1.062	0.002	0.138	0.125	0.015	0.25	STD125-812-125-J1S
	–0.002	1.312	0.003	0.275	0.25	0.02	0.312	STD250-812-250-J1S
	–0.001	1.125	0.002	0.138	0.125	0.015	0.25	STD125-875-125-J1S
0.875	–0.001	1.249	0.002	0.206	0.187	0.015	0.25	STD187-875-187-J1S
	–0.002	1.375	0.003	0.275	0.25	0.02	0.312	STD250-875-250-J1S
	–0.002	1.499	0.004	0.343	0.312	0.02	0.312	STD312-875-312-J1S
	–0.002	1.625	0.005	0.413	0.375	0.03	0.5	STD375-875-375-J1S
	–0.002	1.687	0.005	0.413	0.375	0.03	0.5	STD375-937-375-J1S
	0.937	–0.002	1.687	0.005	0.413	0.375	0.03	0.5
1	–0.001	1.25	0.002	0.138	0.125	0.015	0.25	STD125-1000-125-J1S
	–0.001	1.312	0.002	0.172	0.156	0.015	0.25	STD156-1000-156-J1S
	–0.001	1.374	0.002	0.206	0.187	0.015	0.25	STD187-1000-187-J1S
	–0.002	1.5	0.003	0.275	0.25	0.02	0.312	STD250-1000-250-J1S
	–0.002	1.562	0.003	0.309	0.281	0.02	0.312	STD281-1000-281-J1S
	–0.002	1.624	0.004	0.343	0.312	0.02	0.312	STD312-1000-312-J1S
	–0.002	1.75	0.005	0.413	0.375	0.03	0.5	STD375-1000-375-J1S
	–0.003	2	0.007	0.55	0.5	0.03	0.625	STD500-1000-500-J1S
	–0.001	1.312	0.002	0.138	0.125	0.015	0.25	STD125-1062-125-J1S
–0.001	1.436	0.002	0.206	0.187	0.015	0.25	STD187-1062-187-J1S	

Dimensions				Designation				
d	Tolerance	D	Tolerance	L +0.01	S	R max.	C min.	
in.								-
1.125	-0.001	1.375	0.002	0.138	0.125	0.015	0.25	STD125-1125-125-J15
	-0.001	1.437	0.002	0.172	0.156	0.015	0.25	STD156-1125-156-J15
	-0.001	1.499	0.002	0.206	0.187	0.015	0.25	STD187-1125-187-J15
	-0.002	1.625	0.003	0.275	0.25	0.02	0.312	STD250-1125-250-J15
	-0.002	1.749	0.004	0.343	0.312	0.02	0.312	STD312-1125-312-J15
	-0.002	1.875	0.005	0.413	0.375	0.03	0.5	STD375-1125-375-J15
1.187	-0.001	1.499	0.002	0.172	0.156	0.015	0.25	STD156-1187-156-J15
	-0.001	1.561	0.002	0.206	0.187	0.015	0.25	STD187-1187-187-J15
	-0.002	1.687	0.003	0.275	0.25	0.02	0.312	STD250-1187-250-J15
	-0.002	1.811	0.004	0.343	0.312	0.02	0.312	STD312-1187-312-J15
1.25	-0.001	1.5	0.002	0.138	0.125	0.015	0.25	STD125-1250-125-J15
	-0.001	1.562	0.002	0.172	0.156	0.015	0.25	STD156-1250-156-J15
	-0.001	1.624	0.002	0.206	0.187	0.015	0.25	STD187-1250-187-J15
	-0.002	1.75	0.003	0.275	0.25	0.02	0.312	STD250-1250-250-J15
	-0.002	1.874	0.004	0.343	0.312	0.02	0.312	STD312-1250-312-J15
	-0.002	2	0.005	0.413	0.375	0.03	0.5	STD375-1250-375-J15
	-0.003	2.25	0.007	0.55	0.5	0.03	0.625	STD500-1250-500-J15
-0.003	2.5	0.009	0.688	0.625	0.045	0.875	STD625-1250-625-J15	
1.312	-0.001	1.562	0.002	0.138	0.125	0.015	0.25	STD125-1312-125-J15
	-0.001	1.686	0.002	0.206	0.187	0.015	0.25	STD187-1312-187-J15
	-0.002	1.812	0.003	0.275	0.25	0.02	0.312	STD250-1312-250-J15
	-0.002	2.062	0.005	0.413	0.375	0.03	0.5	STD375-1312-375-J15
1.375	-0.001	1.687	0.002	0.172	0.156	0.015	0.25	STD156-1375-156-J15
	-0.001	1.749	0.002	0.206	0.187	0.015	0.25	STD187-1375-187-J15
	-0.002	1.875	0.003	0.275	0.25	0.02	0.312	STD250-1375-250-J15
	-0.002	1.999	0.004	0.343	0.312	0.02	0.312	STD312-1375-312-J15
	-0.002	2.125	0.005	0.413	0.375	0.03	0.5	STD375-1375-375-J15
1.437	-0.001	1.687	0.002	0.138	0.125	0.015	0.25	STD125-1437-125-J15
	-0.001	1.811	0.002	0.206	0.187	0.015	0.25	STD187-1437-187-J15
	-0.002	1.937	0.003	0.275	0.25	0.02	0.312	STD250-1437-250-J15
	-0.002	2.061	0.004	0.343	0.312	0.02	0.312	STD312-1437-312-J15
1.5	-0.001	1.75	0.002	0.138	0.125	0.015	0.25	STD125-1500-125-J15
	-0.001	1.874	0.002	0.206	0.187	0.015	0.25	STD187-1500-187-J15
	-0.002	2	0.003	0.275	0.25	0.02	0.312	STD250-1500-250-J15
	-0.002	2.124	0.004	0.343	0.312	0.02	0.312	STD312-1500-312-J15
	-0.002	2.25	0.005	0.413	0.375	0.03	0.5	STD375-1500-375-J15
	-0.002	2.374	0.006	0.481	0.437	0.03	0.5	STD437-1500-437-J15
-0.003	2.5	0.007	0.55	0.5	0.03	0.625	STD500-1500-500-J15	
1.562	-0.001	1.812	0.002	0.138	0.125	0.015	0.25	STD125-1562-125-J15
	-0.001	1.936	0.002	0.206	0.187	0.015	0.25	STD187-1562-187-J15
	-0.002	2.312	0.005	0.413	0.375	0.03	0.5	STD375-1562-375-J15
1.593	-0.002	2.093	0.003	0.275	0.25	0.02	0.312	STD250-1593-250-J15
1.625	-0.001	1.875	0.002	0.138	0.125	0.015	0.25	STD125-1625-125-J15
	-0.001	1.999	0.002	0.206	0.187	0.015	0.25	STD187-1625-187-J15
	-0.002	2.125	0.003	0.275	0.25	0.02	0.312	STD250-1625-250-J15
	-0.002	2.249	0.004	0.343	0.312	0.02	0.312	STD312-1625-312-J15
	-0.002	2.375	0.005	0.413	0.375	0.03	0.5	STD375-1625-375-J15
	-0.003	2.625	0.007	0.55	0.5	0.03	0.625	STD500-1625-500-J15
1.687	-0.001	2.061	0.002	0.206	0.187	0.015	0.25	STD187-1687-187-J15
	-0.002	2.311	0.004	0.343	0.312	0.02	0.312	STD312-1687-312-J15
1.75	-0.001	2	0.002	0.138	0.125	0.015	0.25	STD125-1750-125-J15
	-0.001	2.124	0.002	0.206	0.187	0.015	0.25	STD187-1750-187-J15
	-0.002	2.25	0.003	0.275	0.25	0.02	0.312	STD250-1750-250-J15
	-0.002	2.374	0.004	0.343	0.312	0.02	0.312	STD312-1750-312-J15

3.5

3.5 STD profile rod seals, inch sizes d 1.75 – 3.25 in.

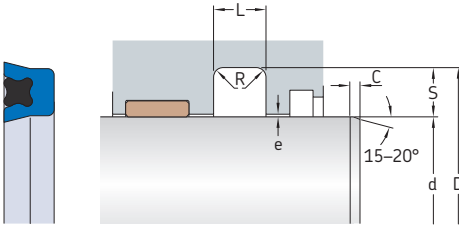

Maximum extrusion gap e

Radial depth S	e _{max} at 60 °C (140 °F) for pressures		
	2 300 psi	3 600 psi	5 800 psi
in.	in.		
0.125	0.008	0.004	–
0.156 to 0.187	0.014	0.008	–
0.218 to 0.25	0.018	0.01	0.004
0.281 to 0.437	0.02	0.012	0.006
0.5 to 0.562	0.024	0.012	0.008
0.625 to 0.75	0.024	0.012	0.008

For additional information → page 34

Dimensions

Designation

d	Tolerance	D	Tolerance	L	S	R	C	Designation
				+0.01		max.	min.	
in.								–
1.75	-0.002	2.5	0.005	0.413	0.375	0.03	0.5	STD375-1750-375-J1S
cont.	-0.003	2.75	0.007	0.55	0.5	0.03	0.625	STD500-1750-500-J1S
	-0.003	3	0.009	0.688	0.625	0.045	0.875	STD625-1750-625-J1S
1.875	-0.001	2.125	0.002	0.138	0.125	0.015	0.25	STD125-1875-125-J1S
	-0.001	2.249	0.002	0.206	0.187	0.015	0.25	STD187-1875-187-J1S
	-0.002	2.375	0.003	0.275	0.25	0.02	0.312	STD250-1875-250-J1S
	-0.002	2.499	0.004	0.343	0.312	0.02	0.312	STD312-1875-312-J1S
	-0.002	2.625	0.005	0.413	0.375	0.03	0.5	STD375-1875-375-J1S
	-0.002	2.749	0.006	0.481	0.437	0.03	0.5	STD437-1875-437-J1S
1.937	-0.002	2.561	0.004	0.343	0.312	0.02	0.312	STD312-1937-312-J1S
2	-0.001	2.374	0.002	0.206	0.187	0.015	0.25	STD187-2000-187-J1S
	-0.002	2.5	0.003	0.275	0.25	0.02	0.312	STD250-2000-250-J1S
	-0.002	2.624	0.004	0.343	0.312	0.02	0.312	STD312-2000-312-J1S
	-0.002	2.75	0.005	0.413	0.375	0.03	0.5	STD375-2000-375-J1S
	-0.003	3	0.007	0.55	0.5	0.03	0.625	STD500-2000-500-J1S
	-0.003	3.25	0.009	0.688	0.625	0.045	0.875	STD625-2000-625-J1S
2.125	-0.001	2.375	0.002	0.138	0.125	0.015	0.25	STD125-2125-125-J1S
	-0.001	2.499	0.002	0.206	0.187	0.015	0.25	STD187-2125-187-J1S
	-0.002	2.625	0.003	0.275	0.25	0.02	0.312	STD250-2125-250-J1S
	-0.002	2.749	0.004	0.343	0.312	0.02	0.312	STD312-2125-312-J1S
	-0.002	2.875	0.005	0.413	0.375	0.03	0.5	STD375-2125-375-J1S
2.25	-0.001	2.624	0.002	0.206	0.187	0.015	0.25	STD187-2250-187-J1S
	-0.002	2.75	0.003	0.275	0.25	0.02	0.312	STD250-2250-250-J1S
	-0.002	2.874	0.004	0.343	0.312	0.02	0.312	STD312-2250-312-J1S
	-0.002	3	0.005	0.413	0.375	0.03	0.5	STD375-2250-375-J1S
	-0.003	3.25	0.007	0.55	0.5	0.03	0.625	STD500-2250-500-J1S
	-0.003	3.5	0.009	0.688	0.625	0.045	0.875	STD625-2250-625-J1S
2.312	-0.002	2.874	0.003	0.309	0.281	0.02	0.312	STD281-2312-281-J1S
2.375	-0.001	2.625	0.002	0.138	0.125	0.015	0.25	STD125-2375-125-J1S
	-0.001	2.749	0.002	0.206	0.187	0.015	0.25	STD187-2375-187-J1S
	-0.002	2.875	0.003	0.275	0.25	0.02	0.312	STD250-2375-250-J1S
	-0.002	2.999	0.004	0.343	0.312	0.02	0.312	STD312-2375-312-J1S
	-0.002	3.125	0.005	0.413	0.375	0.03	0.5	STD375-2375-375-J1S
	-0.003	3.375	0.007	0.55	0.5	0.03	0.625	STD500-2375-500-J1S

Dimensions				Designation				
d	Tolerance	D	Tolerance	L +0.01	S	R max.	C min.	
in.								-
2.437	-0.002	2.937	0.003	0.275	0.25	0.02	0.312	STD250-2437-250-J15
	-0.002	3.187	0.005	0.413	0.375	0.03	0.5	STD375-2437-375-J15
2.5	-0.001	2.75	0.002	0.138	0.125	0.015	0.25	STD125-2500-125-J15
	-0.001	2.874	0.002	0.206	0.187	0.015	0.25	STD187-2500-187-J15
	-0.002	2.936	0.003	0.24	0.218	0.015	0.25	STD218-2500-218-J15
	-0.002	3	0.003	0.275	0.25	0.02	0.312	STD250-2500-250-J15
	-0.002	3.124	0.004	0.343	0.312	0.02	0.312	STD312-2500-312-J15
	-0.002	3.25	0.005	0.413	0.375	0.03	0.5	STD375-2500-375-J15
	-0.002	3.374	0.006	0.481	0.437	0.03	0.5	STD437-2500-437-J15
	-0.003	3.5	0.007	0.55	0.5	0.03	0.625	STD500-2500-500-J15
	-0.003	3.75	0.009	0.688	0.625	0.045	0.875	STD625-2500-625-J15
	2.562	-0.002	3.062	0.003	0.275	0.25	0.02	0.312
-0.002		3.186	0.004	0.343	0.312	0.02	0.312	STD312-2562-312-J15
-0.002		3.312	0.005	0.413	0.375	0.03	0.5	STD375-2562-375-J15
2.625	-0.001	2.875	0.002	0.138	0.125	0.015	0.25	STD125-2625-125-J15
	-0.001	2.999	0.002	0.206	0.187	0.015	0.25	STD187-2625-187-J15
	-0.002	3.125	0.003	0.275	0.25	0.02	0.312	STD250-2625-250-J15
	-0.002	3.249	0.004	0.343	0.312	0.02	0.312	STD312-2625-312-J15
	-0.002	3.375	0.005	0.413	0.375	0.03	0.5	STD375-2625-375-J15
2.75	-0.001	3.124	0.002	0.206	0.187	0.015	0.25	STD187-2750-187-J15
	-0.002	3.25	0.003	0.275	0.25	0.02	0.312	STD250-2750-250-J15
	-0.002	3.374	0.004	0.343	0.312	0.02	0.312	STD312-2750-312-J15
	-0.002	3.5	0.005	0.413	0.375	0.03	0.5	STD375-2750-375-J15
	-0.002	3.624	0.006	0.481	0.437	0.03	0.5	STD437-2750-437-J15
	-0.003	3.75	0.007	0.55	0.5	0.03	0.625	STD500-2750-500-J15
-0.003	4	0.009	0.688	0.625	0.045	0.875	STD625-2750-625-J15	
2.812	-0.002	3.562	0.005	0.413	0.375	0.03	0.5	STD375-2812-375-J15
2.875	-0.001	3.249	0.002	0.206	0.187	0.015	0.25	STD187-2875-187-J15
	-0.002	3.375	0.003	0.275	0.25	0.02	0.312	STD250-2875-250-J15
	-0.002	3.499	0.004	0.343	0.312	0.02	0.312	STD312-2875-312-J15
	-0.002	3.625	0.005	0.413	0.375	0.03	0.5	STD375-2875-375-J15
2.937	-0.002	3.687	0.005	0.413	0.375	0.03	0.5	STD375-2937-375-J15
3	-0.001	3.25	0.002	0.138	0.125	0.015	0.25	STD125-3000-125-J15
	-0.001	3.374	0.002	0.206	0.187	0.015	0.25	STD187-3000-187-J15
	-0.002	3.436	0.003	0.24	0.218	0.015	0.25	STD218-3000-218-J15
	-0.002	3.5	0.003	0.275	0.25	0.02	0.312	STD250-3000-250-J15
	-0.002	3.624	0.004	0.343	0.312	0.02	0.312	STD312-3000-312-J15
	-0.002	3.75	0.005	0.413	0.375	0.03	0.5	STD375-3000-375-J15
	-0.003	4	0.007	0.55	0.5	0.03	0.625	STD500-3000-500-J15
	-0.003	4.25	0.009	0.688	0.625	0.045	0.875	STD625-3000-625-J15
3.125	-0.001	3.375	0.002	0.138	0.125	0.015	0.25	STD125-3125-125-J15
	-0.001	3.499	0.002	0.206	0.187	0.015	0.25	STD187-3125-187-J15
	-0.002	3.625	0.003	0.275	0.25	0.02	0.312	STD250-3125-250-J15
	-0.002	3.749	0.004	0.343	0.312	0.02	0.312	STD312-3125-312-J15
	-0.002	3.875	0.005	0.413	0.375	0.03	0.5	STD375-3125-375-J15
	-0.002	3.999	0.006	0.481	0.437	0.03	0.5	STD437-3125-437-J15
3.25	-0.001	3.5	0.002	0.138	0.125	0.015	0.25	STD125-3250-125-J15
	-0.001	3.624	0.002	0.206	0.187	0.015	0.25	STD187-3250-187-J15
	-0.002	3.75	0.003	0.275	0.25	0.02	0.312	STD250-3250-250-J15
	-0.002	3.874	0.004	0.343	0.312	0.02	0.312	STD312-3250-312-J15
	-0.002	4	0.005	0.413	0.375	0.03	0.5	STD375-3250-375-J15
	-0.002	4.124	0.006	0.481	0.437	0.03	0.5	STD437-3250-437-J15
	-0.003	4.25	0.007	0.55	0.5	0.03	0.625	STD500-3250-500-J15
	-0.003	4.5	0.009	0.688	0.625	0.045	0.875	STD625-3250-625-J15

3.5

3.5 STD profile rod seals, inch sizes d 3.375 – 5.125 in.

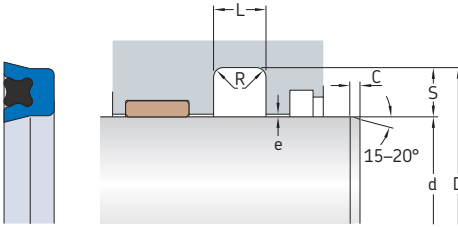

Maximum extrusion gap e

Radial depth S	e _{max} at 60 °C (140 °F) for pressures		
	2 300 psi	3 600 psi	5 800 psi
in.	in.		
0.125	0.008	0.004	–
0.156 to 0.187	0.014	0.008	–
0.218 to 0.25	0.018	0.01	0.004
0.281 to 0.437	0.02	0.012	0.006
0.5 to 0.562	0.024	0.012	0.008
0.625 to 0.75	0.024	0.012	0.008

For additional information → page 34

Dimensions

Designation

d	Tolerance	D	Tolerance	L +0.01	S	R max.	C min.	Designation
in.								–
3.375	–0.001	3.749	0.002	0.206	0.187	0.015	0.25	STD187-3375-187-J1S
	–0.002	3.875	0.003	0.275	0.25	0.02	0.312	STD250-3375-250-J1S
	–0.002	4.125	0.005	0.413	0.375	0.03	0.5	STD375-3375-375-J1S
3.5	–0.001	3.75	0.002	0.138	0.125	0.015	0.25	STD125-3500-125-J1S
	–0.002	4	0.003	0.275	0.25	0.02	0.312	STD250-3500-250-J1S
	–0.002	4.124	0.004	0.343	0.312	0.02	0.312	STD312-3500-312-J1S
	–0.002	4.25	0.005	0.413	0.375	0.03	0.5	STD375-3500-375-J1S
	–0.003	4.5	0.007	0.55	0.5	0.03	0.625	STD500-3500-500-J1S
	–0.003	4.75	0.009	0.688	0.625	0.045	0.875	STD625-3500-625-J1S
–0.003	5	0.011	0.825	0.75	0.045	1	STD750-3500-750-J1S	
3.625	–0.001	3.999	0.002	0.206	0.187	0.015	0.25	STD187-3625-187-J1S
	–0.002	4.125	0.003	0.275	0.25	0.02	0.312	STD250-3625-250-J1S
	–0.002	4.249	0.004	0.343	0.312	0.02	0.312	STD312-3625-312-J1S
	–0.002	4.375	0.005	0.413	0.375	0.03	0.5	STD375-3625-375-J1S
3.75	–0.001	4	0.002	0.138	0.125	0.015	0.25	STD125-3750-125-J1S
	–0.001	4.124	0.002	0.206	0.187	0.015	0.25	STD187-3750-187-J1S
	–0.002	4.25	0.003	0.275	0.25	0.02	0.312	STD250-3750-250-J1S
	–0.002	4.374	0.004	0.343	0.312	0.02	0.312	STD312-3750-312-J1S
	–0.002	4.5	0.005	0.413	0.375	0.03	0.5	STD375-3750-375-J1S
	–0.003	4.75	0.007	0.55	0.5	0.03	0.625	STD500-3750-500-J1S
–0.003	5	0.009	0.688	0.625	0.045	0.875	STD625-3750-625-J1S	
3.875	–0.001	4.249	0.002	0.206	0.187	0.015	0.25	STD187-3875-187-J1S
	–0.002	4.375	0.003	0.275	0.25	0.02	0.312	STD250-3875-250-J1S
	–0.002	4.499	0.004	0.343	0.312	0.02	0.312	STD312-3875-312-J1S
	–0.002	4.625	0.005	0.413	0.375	0.03	0.5	STD375-3875-375-J1S
4	–0.001	4.25	0.002	0.138	0.125	0.015	0.25	STD125-4000-125-J1S
	–0.001	4.374	0.002	0.206	0.187	0.015	0.25	STD187-4000-187-J1S
	–0.002	4.5	0.003	0.275	0.25	0.02	0.312	STD250-4000-250-J1S
	–0.002	4.624	0.004	0.343	0.312	0.02	0.312	STD312-4000-312-J1S
	–0.002	4.75	0.005	0.413	0.375	0.03	0.5	STD375-4000-375-J1S
	–0.002	4.874	0.006	0.481	0.437	0.03	0.5	STD437-4000-437-J1S
	–0.003	5	0.007	0.55	0.5	0.03	0.625	STD500-4000-500-J1S
	–0.003	5.25	0.009	0.688	0.625	0.045	0.875	STD625-4000-625-J1S

Dimensions				Designation					
d	Tolerance	D	Tolerance	L +0.01	S	R max.	C min.		
in.								-	
4.125	-0.001	4.499	0.002	0.206	0.187	0.015	0.25	STD187-4125-187-J15	
	-0.002	4.625	0.003	0.275	0.25	0.02	0.312	STD250-4125-250-J15	
	-0.002	4.749	0.004	0.343	0.312	0.02	0.312	STD312-4125-312-J15	
	-0.002	4.875	0.005	0.413	0.375	0.03	0.5	STD375-4125-375-J15	
	-0.002	4.999	0.006	0.481	0.437	0.03	0.5	STD437-4125-437-J15	
4.25	-0.001	4.5	0.002	0.138	0.125	0.015	0.25	STD125-4250-125-J15	
	-0.001	4.624	0.002	0.206	0.187	0.015	0.25	STD187-4250-187-J15	
	-0.002	4.75	0.003	0.275	0.25	0.02	0.312	STD250-4250-250-J15	
	-0.002	4.874	0.004	0.343	0.312	0.02	0.312	STD312-4250-312-J15	
	-0.002	5	0.005	0.413	0.375	0.03	0.5	STD375-4250-375-J15	
4.375	-0.001	4.625	0.002	0.138	0.125	0.015	0.25	STD125-4375-125-J15	
	-0.001	4.749	0.002	0.206	0.187	0.015	0.25	STD187-4375-187-J15	
	-0.002	4.875	0.003	0.275	0.25	0.02	0.312	STD250-4375-250-J15	
	-0.002	4.999	0.004	0.343	0.312	0.02	0.312	STD312-4375-312-J15	
	-0.002	5.125	0.005	0.413	0.375	0.03	0.5	STD375-4375-375-J15	
4.437	-0.002	4.999	0.003	0.309	0.281	0.02	0.312	STD281-4437-281-J15	
4.5	-0.001	4.75	0.002	0.138	0.125	0.015	0.25	STD125-4500-125-J15	
	-0.001	4.874	0.002	0.206	0.187	0.015	0.25	STD187-4500-187-J15	
	-0.002	5	0.003	0.275	0.25	0.02	0.312	STD250-4500-250-J15	
	-0.002	5.124	0.004	0.343	0.312	0.02	0.312	STD312-4500-312-J15	
	-0.002	5.25	0.005	0.413	0.375	0.03	0.5	STD375-4500-375-J15	
4.625	-0.002	5.374	0.006	0.481	0.437	0.03	0.5	STD437-4500-437-J15	
	-0.003	5.5	0.007	0.55	0.5	0.03	0.625	STD500-4500-500-J15	
	-0.003	5.75	0.009	0.688	0.625	0.045	0.875	STD625-4500-625-J15	
	-0.003	6	0.011	0.825	0.75	0.045	1	STD750-4500-750-J15	
	4.625	-0.001	4.999	0.002	0.206	0.187	0.015	0.25	STD187-4625-187-J15
-0.002		5.125	0.003	0.275	0.25	0.02	0.312	STD250-4625-250-J15	
-0.002		5.375	0.005	0.413	0.375	0.03	0.5	STD375-4625-375-J15	
4.75	-0.001	5	0.002	0.138	0.125	0.015	0.25	STD125-4750-125-J15	
	-0.001	5.124	0.002	0.206	0.187	0.015	0.25	STD187-4750-187-J15	
	-0.002	5.25	0.003	0.275	0.25	0.02	0.312	STD250-4750-250-J15	
	-0.002	5.374	0.004	0.343	0.312	0.02	0.312	STD312-4750-312-J15	
	-0.002	5.5	0.005	0.413	0.375	0.03	0.5	STD375-4750-375-J15	
4.875	-0.002	5.624	0.006	0.481	0.437	0.03	0.5	STD437-4750-437-J15	
	-0.003	5.75	0.007	0.55	0.5	0.03	0.625	STD500-4750-500-J15	
	-0.003	6	0.009	0.688	0.625	0.045	0.875	STD625-4750-625-J15	
	4.875	-0.001	5.249	0.002	0.206	0.187	0.015	0.25	STD187-4875-187-J15
		-0.002	5.375	0.003	0.275	0.25	0.02	0.312	STD250-4875-250-J15
-0.002		5.499	0.004	0.343	0.312	0.02	0.312	STD312-4875-312-J15	
-0.002	5.625	0.005	0.413	0.375	0.03	0.5	STD375-4875-375-J15		
5	-0.001	5.374	0.002	0.206	0.187	0.015	0.25	STD187-5000-187-J15	
	-0.002	5.5	0.003	0.275	0.25	0.02	0.312	STD250-5000-250-J15	
	-0.002	5.562	0.003	0.309	0.281	0.02	0.312	STD281-5000-281-J15	
	-0.002	5.624	0.004	0.343	0.312	0.02	0.312	STD312-5000-312-J15	
	-0.002	5.75	0.005	0.413	0.375	0.03	0.5	STD375-5000-375-J15	
5.125	-0.003	6	0.007	0.55	0.5	0.03	0.625	STD500-5000-500-J15	
	-0.003	6.25	0.009	0.688	0.625	0.045	0.875	STD625-5000-625-J15	
	-0.003	6.5	0.011	0.825	0.75	0.045	1	STD750-5000-750-J15	
	5.125	-0.002	5.625	0.003	0.275	0.25	0.02	0.312	STD250-5125-250-J15
		-0.002	5.749	0.004	0.343	0.312	0.02	0.312	STD312-5125-312-J15
-0.002		5.875	0.005	0.413	0.375	0.03	0.5	STD375-5125-375-J15	
-0.002	5.999	0.006	0.481	0.437	0.03	0.5	STD437-5125-437-J15		

3.5

3.5 STD profile rod seals, inch sizes d 5.25 – 8.125 in.

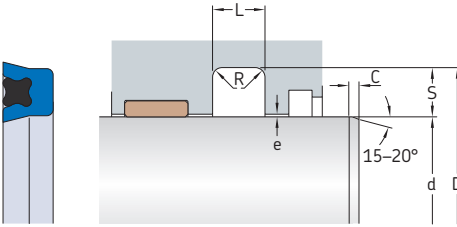

Maximum extrusion gap e

Radial depth S	e _{max} at 60 °C (140 °F) for pressures		
	2 300 psi	3 600 psi	5 800 psi
in.	in.		
0.125	0.008	0.004	–
0.156 to 0.187	0.014	0.008	–
0.218 to 0.25	0.018	0.01	0.004
0.281 to 0.437	0.02	0.012	0.006
0.5 to 0.562	0.024	0.012	0.008
0.625 to 0.75	0.024	0.012	0.008

For additional information → page 34

Dimensions

Designation

d	Tolerance	D	Tolerance	L +0.01	S	R max.	C min.	Designation
in.								–
5.25	-0.002	5.75	0.003	0.275	0.25	0.02	0.312	STD250-5250-250-J15
	-0.002	5.874	0.004	0.343	0.312	0.02	0.312	STD312-5250-312-J15
	-0.002	6	0.005	0.413	0.375	0.03	0.5	STD375-5250-375-J15
	-0.002	6.124	0.006	0.481	0.437	0.03	0.5	STD437-5250-437-J15
	-0.003	6.25	0.007	0.55	0.5	0.03	0.625	STD500-5250-500-J15
	-0.003	6.5	0.009	0.688	0.625	0.045	0.875	STD625-5250-625-J15
5.375	-0.002	5.875	0.003	0.275	0.25	0.02	0.312	STD250-5375-250-J15
	-0.002	5.999	0.004	0.343	0.312	0.02	0.312	STD312-5375-312-J15
	-0.002	6.125	0.005	0.413	0.375	0.03	0.5	STD375-5375-375-J15
5.437	-0.002	5.999	0.003	0.309	0.281	0.02	0.312	STD281-5437-281-J15
	-0.003	6.437	0.007	0.55	0.5	0.03	0.625	STD500-5437-500-J15
5.5	-0.001	5.874	0.002	0.206	0.187	0.015	0.25	STD187-5500-187-J15
	-0.002	6	0.003	0.275	0.25	0.02	0.312	STD250-5500-250-J15
	-0.002	6.124	0.004	0.343	0.312	0.02	0.312	STD312-5500-312-J15
	-0.002	6.25	0.005	0.413	0.375	0.03	0.5	STD375-5500-375-J15
	-0.003	6.5	0.007	0.55	0.5	0.03	0.625	STD500-5500-500-J15
	-0.003	6.624	0.007	0.618	0.562	0.03	0.75	STD562-5500-562-J15
	-0.003	6.75	0.009	0.688	0.625	0.045	0.875	STD625-5500-625-J15
	-0.003	7	0.011	0.825	0.75	0.045	1	STD750-5500-750-J15
5.625	-0.002	6.125	0.003	0.275	0.25	0.02	0.312	STD250-5625-250-J15
	-0.002	6.249	0.004	0.343	0.312	0.02	0.312	STD312-5625-312-J15
	-0.002	6.375	0.005	0.413	0.375	0.03	0.5	STD375-5625-375-J15
5.75	-0.001	6	0.002	0.138	0.125	0.015	0.25	STD125-5750-125-J15
	-0.002	6.25	0.003	0.275	0.25	0.02	0.312	STD250-5750-250-J15
	-0.002	6.5	0.005	0.413	0.375	0.03	0.5	STD375-5750-375-J15
	-0.003	6.75	0.007	0.55	0.5	0.03	0.625	STD500-5750-500-J15
	-0.003	7	0.009	0.688	0.625	0.045	0.875	STD625-5750-625-J15
5.875	-0.002	6.375	0.003	0.275	0.25	0.02	0.312	STD250-5875-250-J15
	-0.002	6.499	0.004	0.343	0.312	0.02	0.312	STD312-5875-312-J15
	-0.002	6.625	0.005	0.413	0.375	0.03	0.5	STD375-5875-375-J15
6	-0.001	6.374	0.002	0.206	0.187	0.015	0.25	STD187-6000-187-J15
	-0.002	6.5	0.003	0.275	0.25	0.02	0.312	STD250-6000-250-J15
	-0.002	6.624	0.004	0.343	0.312	0.02	0.312	STD312-6000-312-J15
	-0.002	6.75	0.005	0.413	0.375	0.03	0.5	STD375-6000-375-J15

Dimensions				Designation				
d	Tolerance	D	Tolerance	L +0.01	S	R max.	C min.	
in.								-
6	-0.003	7	0.007	0.55	0.5	0.03	0.625	STD500-6000-500-J15
	-0.003	7.25	0.009	0.688	0.625	0.045	0.875	STD625-6000-625-J15
	-0.003	7.5	0.011	0.825	0.75	0.045	1	STD750-6000-750-J15
6.125	-0.002	6.749	0.004	0.343	0.312	0.02	0.312	STD312-6125-312-J15
	-0.003	7.125	0.007	0.55	0.5	0.03	0.625	STD500-6125-500-J15
6.25	-0.002	6.75	0.003	0.275	0.25	0.02	0.312	STD250-6250-250-J15
	-0.002	6.874	0.004	0.343	0.312	0.02	0.312	STD312-6250-312-J15
	-0.002	7	0.005	0.413	0.375	0.03	0.5	STD375-6250-375-J15
	-0.003	7.25	0.007	0.55	0.5	0.03	0.625	STD500-6250-500-J15
	-0.003	7.5	0.009	0.688	0.625	0.045	0.875	STD625-6250-625-J15
6.375	-0.002	6.999	0.004	0.343	0.312	0.02	0.312	STD312-6375-312-J15
	-0.002	7.125	0.005	0.413	0.375	0.03	0.5	STD375-6375-375-J15
6.5	-0.002	7	0.003	0.275	0.25	0.02	0.312	STD250-6500-250-J15
	-0.002	7.124	0.004	0.343	0.312	0.02	0.312	STD312-6500-312-J15
	-0.002	7.25	0.005	0.413	0.375	0.03	0.5	STD375-6500-375-J15
	-0.003	7.5	0.007	0.55	0.5	0.03	0.625	STD500-6500-500-J15
	-0.003	8	0.011	0.825	0.75	0.045	1	STD750-6500-750-J15
6.625	-0.002	7.249	0.004	0.343	0.312	0.02	0.312	STD312-6625-312-J15
6.75	-0.002	7.25	0.003	0.275	0.25	0.02	0.312	STD250-6750-250-J15
	-0.002	7.374	0.004	0.343	0.312	0.02	0.312	STD312-6750-312-J15
	-0.002	7.5	0.005	0.413	0.375	0.03	0.5	STD375-6750-375-J15
	-0.003	7.75	0.007	0.55	0.5	0.03	0.625	STD500-6750-500-J15
	-0.003	8	0.009	0.688	0.625	0.045	0.875	STD625-6750-625-J15
7	-0.002	7.5	0.003	0.275	0.25	0.02	0.312	STD250-7000-250-J15
	-0.002	7.75	0.005	0.413	0.375	0.03	0.5	STD375-7000-375-J15
	-0.003	8	0.007	0.55	0.5	0.03	0.625	STD500-7000-500-J15
	-0.003	8.25	0.009	0.688	0.625	0.045	0.875	STD625-7000-625-J15
	-0.003	8.5	0.011	0.825	0.75	0.045	1	STD750-7000-750-J15
7.125	-0.003	8.125	0.007	0.55	0.5	0.03	0.625	STD500-7125-500-J15
7.25	-0.002	7.75	0.003	0.275	0.25	0.02	0.312	STD250-7250-250-J15
	-0.002	7.874	0.004	0.343	0.312	0.02	0.312	STD312-7250-312-J15
	-0.002	8	0.005	0.413	0.375	0.03	0.5	STD375-7250-375-J15
	-0.003	8.25	0.007	0.55	0.5	0.03	0.625	STD500-7250-500-J15
	-0.003	8.5	0.009	0.688	0.625	0.045	0.875	STD625-7250-625-J15
7.375	-0.002	7.999	0.004	0.343	0.312	0.02	0.312	STD312-7375-312-J15
7.5	-0.002	8	0.003	0.275	0.25	0.02	0.312	STD250-7500-250-J15
	-0.002	8.124	0.004	0.343	0.312	0.02	0.312	STD312-7500-312-J15
	-0.002	8.25	0.005	0.413	0.375	0.03	0.5	STD375-7500-375-J15
	-0.003	8.5	0.007	0.55	0.5	0.03	0.625	STD500-7500-500-J15
	-0.003	9	0.011	0.825	0.75	0.045	1	STD750-7500-750-J15
7.625	-0.002	8.375	0.005	0.413	0.375	0.03	0.5	STD375-7625-375-J15
7.75	-0.002	8.25	0.003	0.275	0.25	0.02	0.312	STD250-7750-250-J15
	-0.002	8.5	0.005	0.413	0.375	0.03	0.5	STD375-7750-375-J15
	-0.003	8.75	0.007	0.55	0.5	0.03	0.625	STD500-7750-500-J15
	-0.003	9	0.009	0.688	0.625	0.045	0.875	STD625-7750-625-J15
8	-0.002	8.5	0.003	0.275	0.25	0.02	0.312	STD250-8000-250-J15
	-0.002	8.75	0.005	0.413	0.375	0.03	0.5	STD375-8000-375-J15
	-0.003	9	0.007	0.55	0.5	0.03	0.625	STD500-8000-500-J15
	-0.003	9.25	0.009	0.688	0.625	0.045	0.875	STD625-8000-625-J15
	-0.003	9.5	0.011	0.825	0.75	0.045	1	STD750-8000-750-J15
8.125	-0.002	8.625	0.003	0.275	0.25	0.02	0.312	STD250-8125-250-J15

3.5

3.5 STD profile rod seals, inch sizes d 8.25 – 13.75 in.

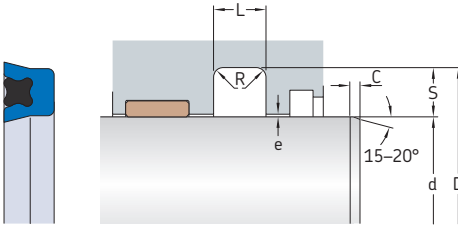

Maximum extrusion gap e

Radial depth S	e _{max} at 60 °C (140 °F) for pressures		
	2 300 psi	3 600 psi	5 800 psi
in.	in.		
0.125	0.008	0.004	–
0.156 to 0.187	0.014	0.008	–
0.218 to 0.25	0.018	0.01	0.004
0.281 to 0.437	0.02	0.012	0.006
0.5 to 0.562	0.024	0.012	0.008
0.625 to 0.75	0.024	0.012	0.008

For additional information → page 34

Dimensions

Designation

d	Tolerance	D	Tolerance	L +0.01	S	R max.	C min.	Designation
in.								–
8.25	-0.002	8.75	0.003	0.275	0.25	0.02	0.312	STD250-8250-250-J1S
	-0.002	9	0.005	0.413	0.375	0.03	0.5	STD375-8250-375-J1S
	-0.003	9.25	0.007	0.55	0.5	0.03	0.625	STD500-8250-500-J1S
8.5	-0.002	9	0.003	0.275	0.25	0.02	0.312	STD250-8500-250-J1S
	-0.002	9.25	0.005	0.413	0.375	0.03	0.5	STD375-8500-375-J1S
	-0.003	9.5	0.007	0.55	0.5	0.03	0.625	STD500-8500-500-J1S
	-0.003	9.75	0.009	0.688	0.625	0.045	0.875	STD625-8500-625-J1S
	-0.003	10	0.011	0.825	0.75	0.045	1	STD750-8500-750-J1S
8.625	-0.002	9.375	0.005	0.413	0.375	0.03	0.5	STD375-8625-375-J1S
8.75	-0.002	9.25	0.003	0.275	0.25	0.02	0.312	STD250-8750-250-J1S
	-0.002	9.5	0.005	0.413	0.375	0.03	0.5	STD375-8750-375-J1S
	-0.003	9.75	0.007	0.55	0.5	0.03	0.625	STD500-8750-500-J1S
	-0.003	10	0.009	0.688	0.625	0.045	0.875	STD625-8750-625-J1S
8.875	-0.002	9.499	0.004	0.343	0.312	0.02	0.312	STD312-8875-312-J1S
9	-0.002	9.5	0.003	0.275	0.25	0.02	0.312	STD250-9000-250-J1S
	-0.002	9.75	0.005	0.413	0.375	0.03	0.5	STD375-9000-375-J1S
	-0.003	10	0.007	0.55	0.5	0.03	0.625	STD500-9000-500-J1S
	-0.003	10.25	0.009	0.688	0.625	0.045	0.875	STD625-9000-625-J1S
	-0.003	10.5	0.011	0.825	0.75	0.045	1	STD750-9000-750-J1S
9.25	-0.002	9.75	0.003	0.275	0.25	0.02	0.312	STD250-9250-250-J1S
	-0.003	10.5	0.009	0.688	0.625	0.045	0.875	STD625-9250-625-J1S
9.312	-0.002	9.998	0.004	0.377	0.343	0.02	0.312	STD343-9312-343-J1S
9.5	-0.002	10	0.003	0.275	0.25	0.02	0.312	STD250-9500-250-J1S
	-0.002	10.25	0.005	0.413	0.375	0.03	0.5	STD375-9500-375-J1S
	-0.003	10.5	0.007	0.55	0.5	0.03	0.625	STD500-9500-500-J1S
	-0.003	10.75	0.009	0.688	0.625	0.045	0.875	STD625-9500-625-J1S
	-0.003	11	0.011	0.825	0.75	0.045	1	STD750-9500-750-J1S
9.75	-0.002	10.25	0.003	0.275	0.25	0.02	0.312	STD250-9750-250-J1S
	-0.002	10.5	0.005	0.413	0.375	0.03	0.5	STD375-9750-375-J1S
	-0.003	10.75	0.007	0.55	0.5	0.03	0.625	STD500-9750-500-J1S
	-0.003	11	0.009	0.688	0.625	0.045	0.875	STD625-9750-625-J1S

Dimensions				Designation				
d	Tolerance	D	Tolerance	L +0.01	S	R max.	C min.	
in.								-
9.875	-0.002	10.625	0.005	0.413	0.375	0.03	0.5	STD375-9875-375-J1S
10	-0.002	10.5	0.003	0.275	0.25	0.02	0.312	STD250-10000-250-J1S
	-0.002	10.75	0.005	0.413	0.375	0.03	0.5	STD375-10000-375-J1S
	-0.003	11	0.007	0.55	0.5	0.03	0.625	STD500-10000-500-J1S
	-0.003	11.25	0.009	0.688	0.625	0.045	0.875	STD625-10000-625-J1S
	-0.003	11.5	0.011	0.825	0.75	0.045	1	STD750-10000-750-J1S
10.25	-0.002	10.75	0.003	0.275	0.25	0.02	0.312	STD250-10250-250-J1S
	-0.002	11	0.005	0.413	0.375	0.03	0.5	STD375-10250-375-J1S
	-0.003	11.5	0.009	0.688	0.625	0.045	0.875	STD625-10250-625-J1S
10.5	-0.002	11	0.003	0.275	0.25	0.02	0.312	STD250-10500-250-J1S
	-0.002	11.25	0.005	0.413	0.375	0.03	0.5	STD375-10500-375-J1S
	-0.003	11.5	0.007	0.55	0.5	0.03	0.625	STD500-10500-500-J1S
	-0.003	12	0.011	0.825	0.75	0.045	1	STD750-10500-750-J1S
10.75	-0.002	11.25	0.003	0.275	0.25	0.02	0.312	STD250-10750-250-J1S
	-0.002	11.5	0.005	0.413	0.375	0.03	0.5	STD375-10750-375-J1S
	-0.003	11.75	0.007	0.55	0.5	0.03	0.625	STD500-10750-500-J1S
	-0.003	12	0.009	0.688	0.625	0.045	0.875	STD625-10750-625-J1S
11	-0.002	11.75	0.005	0.413	0.375	0.03	0.5	STD375-11000-375-J1S
	-0.003	12	0.007	0.55	0.5	0.03	0.625	STD500-11000-500-J1S
	-0.003	12.25	0.009	0.688	0.625	0.045	0.875	STD625-11000-625-J1S
	-0.003	12.5	0.011	0.825	0.75	0.045	1	STD750-11000-750-J1S
11.25	-0.002	11.75	0.003	0.275	0.25	0.02	0.312	STD250-11250-250-J1S
	-0.002	12	0.005	0.413	0.375	0.03	0.5	STD375-11250-375-J1S
	-0.003	12.25	0.007	0.55	0.5	0.03	0.625	STD500-11250-500-J1S
11.5	-0.002	12	0.003	0.275	0.25	0.02	0.312	STD250-11500-250-J1S
	-0.003	12.5	0.007	0.55	0.5	0.03	0.625	STD500-11500-500-J1S
11.75	-0.002	12.25	0.003	0.275	0.25	0.02	0.312	STD250-11750-250-J1S
	-0.002	12.5	0.005	0.413	0.375	0.03	0.5	STD375-11750-375-J1S
	-0.003	13	0.009	0.688	0.625	0.045	0.875	STD625-11750-625-J1S
12	-0.002	12.5	0.003	0.275	0.25	0.02	0.312	STD250-12000-250-J1S
	-0.002	12.75	0.005	0.413	0.375	0.03	0.5	STD375-12000-375-J1S
	-0.003	13	0.007	0.55	0.5	0.03	0.625	STD500-12000-500-J1S
	-0.003	13.25	0.009	0.688	0.625	0.045	0.875	STD625-12000-625-J1S
12.25	-0.002	13	0.005	0.413	0.375	0.03	0.5	STD375-12250-375-J1S
12.5	-0.002	13	0.003	0.275	0.25	0.02	0.312	STD250-12500-250-J1S
	-0.003	13.5	0.007	0.55	0.5	0.03	0.625	STD500-12500-500-J1S
	-0.003	14	0.011	0.825	0.75	0.045	1	STD750-12500-750-J1S
12.75	-0.002	13.5	0.005	0.413	0.375	0.03	0.5	STD375-12750-375-J1S
	-0.003	14	0.009	0.688	0.625	0.045	0.875	STD625-12750-625-J1S
13	-0.002	13.75	0.005	0.413	0.375	0.03	0.5	STD375-13000-375-J1S
	-0.003	14	0.007	0.55	0.5	0.03	0.625	STD500-13000-500-J1S
	-0.003	14.25	0.009	0.688	0.625	0.045	0.875	STD625-13000-625-J1S
	-0.003	14.5	0.011	0.825	0.75	0.045	1	STD750-13000-750-J1S
13.25	-0.002	14	0.005	0.413	0.375	0.03	0.5	STD375-13250-375-J1S
	-0.003	14.25	0.007	0.55	0.5	0.03	0.625	STD500-13250-500-J1S
13.375	-0.002	14.125	0.005	0.413	0.375	0.03	0.5	STD375-13375-375-J1S
13.5	-0.002	14	0.003	0.275	0.25	0.02	0.312	STD250-13500-250-J1S
	-0.003	14.5	0.007	0.55	0.5	0.03	0.625	STD500-13500-500-J1S
	-0.003	15	0.011	0.825	0.75	0.045	1	STD750-13500-750-J1S
13.75	-0.002	14.5	0.005	0.413	0.375	0.03	0.5	STD375-13750-375-J1S

3.5

3.5 STD profile rod seals, inch sizes d 14 – 45 in.

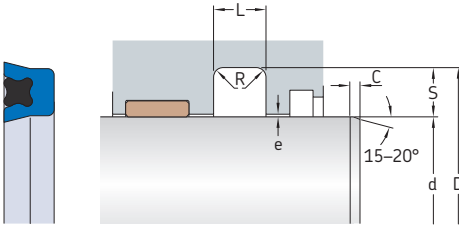

Maximum extrusion gap e

Radial depth S	e _{max} at 60 °C (140 °F) for pressures		
	2 300 psi	3 600 psi	5 800 psi
in.	in.		
0.125	0.008	0.004	–
0.156 to 0.187	0.014	0.008	–
0.218 to 0.25	0.018	0.01	0.004
0.281 to 0.437	0.02	0.012	0.006
0.5 to 0.562	0.024	0.012	0.008
0.625 to 0.75	0.024	0.012	0.008

For additional information → page 34

Dimensions

Designation

d	Tolerance	D	Tolerance	L +0.01	S	R max.	C min.	Designation
in.								–
14	–0.002	14.75	0.005	0.413	0.375	0.03	0.5	STD375-14000-375-J1S
	–0.003	15	0.007	0.55	0.5	0.03	0.625	STD500-14000-500-J1S
	–0.003	15.5	0.011	0.825	0.75	0.045	1	STD750-14000-750-J1S
14.25	–0.002	14.75	0.003	0.275	0.25	0.02	0.312	STD250-14250-250-J1S
14.375	–0.002	14.999	0.004	0.343	0.312	0.02	0.312	STD312-14375-312-J1S
14.5	–0.003	16	0.011	0.825	0.75	0.045	1	STD750-14500-750-J1S
15	–0.002	15.75	0.005	0.413	0.375	0.03	0.5	STD375-15000-375-J1S
	–0.003	16	0.007	0.55	0.5	0.03	0.625	STD500-15000-500-J1S
15.5	–0.002	16.25	0.005	0.413	0.375	0.03	0.5	STD375-15500-375-J1S
	–0.003	16.5	0.007	0.55	0.5	0.03	0.625	STD500-15500-500-J1S
16	–0.003	17	0.007	0.55	0.5	0.03	0.625	STD500-16000-500-J1S
	–0.003	17.5	0.011	0.825	0.75	0.045	1	STD750-16000-750-J1S
16.5	–0.003	17.5	0.007	0.55	0.5	0.03	0.625	STD500-16500-500-J1S
	–0.003	18	0.011	0.825	0.75	0.045	1	STD750-16500-750-J1S
16.75	–0.002	17.25	0.003	0.275	0.25	0.02	0.312	STD250-16750-250-J1S
16.875	–0.002	17.625	0.005	0.413	0.375	0.03	0.5	STD375-16875-375-J1S
17	–0.003	18	0.007	0.55	0.5	0.03	0.625	STD500-17000-500-J1S
17.25	–0.002	18	0.005	0.413	0.375	0.03	0.5	STD375-17250-375-J1S
	–0.003	18.5	0.009	0.688	0.625	0.045	0.875	STD625-17250-625-J1S
18	–0.003	19	0.007	0.55	0.5	0.03	0.625	STD500-18000-500-J1S
	–0.003	19.5	0.011	0.825	0.75	0.045	1	STD750-18000-750-J1S
18.375	–0.002	18.875	0.003	0.275	0.25	0.02	0.312	STD250-18375-250-J1S
19.5	–0.002	20.25	0.005	0.413	0.375	0.03	0.5	STD375-19500-375-J1S
20	–0.003	21	0.007	0.55	0.5	0.03	0.625	STD500-20000-500-J1S
20.5	–0.003	22	0.011	0.825	0.75	0.045	1	STD750-20500-750-J1S

Dimensions								Designation
d	Tolerance	D	Tolerance	L +0.01	S	R max.	C min.	
in.								-
20.75	-0.002	21.25	0.003	0.275	0.25	0.02	0.312	STD250-20750-250-J1S
21	-0.003	22	0.007	0.55	0.5	0.03	0.625	STD500-21000-500-J1S
22	-0.003	23	0.007	0.55	0.5	0.03	0.625	STD500-22000-500-J1S
23	-0.002	23.5	0.003	0.275	0.25	0.02	0.312	STD250-23000-250-J1S
23.5	-0.003	24.5	0.007	0.55	0.5	0.03	0.625	STD500-23500-500-J1S
24	-0.003	25.25	0.009	0.688	0.625	0.045	0.875	STD625-24000-625-J1S
24.75	-0.003	26	0.009	0.688	0.625	0.045	0.875	STD625-24750-625-J1S
25	-0.003	26	0.007	0.55	0.5	0.03	0.625	STD500-25000-500-J1S
26.5	-0.003	27.5	0.007	0.55	0.5	0.03	0.625	STD500-26500-500-J1S
27	-0.003	28	0.007	0.55	0.5	0.03	0.625	STD500-27000-500-J1S
27.5	-0.003	28.5	0.007	0.55	0.5	0.03	0.625	STD500-27500-500-J1S
28.5	-0.003	29.5	0.007	0.55	0.5	0.03	0.625	STD500-28500-500-J1S
31	-0.003	32	0.007	0.55	0.5	0.03	0.625	STD500-31000-500-J1S
32	-0.003	33	0.007	0.55	0.5	0.03	0.625	STD500-32000-500-J1S
34.25	-0.003	35.75	0.011	0.825	0.75	0.045	1	STD750-34250-750-J1S
35.75	-0.003	36.75	0.007	0.55	0.5	0.03	0.625	STD500-35750-500-J1S
36	-0.003	37	0.007	0.55	0.5	0.03	0.625	STD500-36000-500-J1S
	-0.003	37.5	0.011	0.825	0.75	0.045	1	STD750-36000-750-J1S
36.75	-0.003	37.75	0.007	0.55	0.5	0.03	0.625	STD500-36750-500-J1S
37	-0.003	38	0.007	0.55	0.5	0.03	0.625	STD500-37000-500-J1S
38	-0.003	39	0.007	0.55	0.5	0.03	0.625	STD500-38000-500-J1S
39	-0.003	40	0.007	0.55	0.5	0.03	0.625	STD500-39000-500-J1S
40	-0.003	41	0.007	0.55	0.5	0.03	0.625	STD500-40000-500-J1S
40.25	-0.003	41.25	0.007	0.55	0.5	0.03	0.625	STD500-40250-500-J1S
41	-0.003	42	0.007	0.55	0.5	0.03	0.625	STD500-41000-500-J1S
42	-0.003	43	0.007	0.55	0.5	0.03	0.625	STD500-42000-500-J1S
42.75	-0.003	43.75	0.007	0.55	0.5	0.03	0.625	STD500-42750-500-J1S
43	-0.003	44	0.007	0.55	0.5	0.03	0.625	STD500-43000-500-J1S
44.5	-0.003	45.5	0.007	0.55	0.5	0.03	0.625	STD500-44500-500-J1S
45	-0.003	46	0.007	0.55	0.5	0.03	0.625	STD500-45000-500-J1S

Other sizes are available on request

DZ profile data



Material codes	Primary sealing ring: A-8504 Secondary sealing ring: U-1003 For additional information → page 26
Pressure	Up to 400 bar (5 800 psi)
Speed	Up to 1 m/s (3.2 ft/s)
Temperature range	<div style="display: flex; align-items: center;"> <div style="margin-left: 10px;"> <p>-60 -50 100 110 120 [°C] -75 -60 210 230 250 [°F]</p> </div> </div> <ul style="list-style-type: none"> ■ Extreme low temperature range: seal performance depends on system design (precision guiding arrangement recommended) ■ Recommended operating temperature range for this profile and material ■ Temperatures above the recommended operating range: acceptable only with reduced pressure, speed, and/or e-gap ■ Extreme high temperature range: only occasional short-term exposure (e.g. cylinder in curing oven of a powder coating process)
Counter-surface	→ page 22

Maximum values of application parameters (e.g. pressure, speed, temperature, e-gap) should not be applied continuously nor simultaneously.

3.6 DZ profile rod seals, metric sizes d 25 – 105 mm

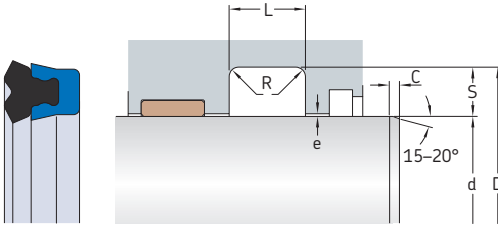

Maximum extrusion gap e

Radial depth S	e_{\max} at 60 °C (140 °F) for pressures		
	160 bar	250 bar	400 bar
mm	mm		
4	0,35	0,2	–
5	0,45	0,25	0,1
7,5	0,5	0,3	0,15

For additional information → [page 34](#)

3.6

Dimensions

d f8 or h9	D H10	L +0,2	S	R max.	C min.
---------------	----------	-----------	---	-----------	-----------

mm

Designation

–

25	33	7,2	4	0,2	6	DZ-25x33x7.2-E2F
30	40	9,9	5	0,2	6	DZ-30x40x9.9-E2F
35	45	9,9	5	0,2	6	DZ-35x45x9.9-E2F
40	50	8	5	0,2	6	DZ-40x50x8-E2F
	50	9,9	5	0,2	6	DZ-40x50x9.9-E2F
45	55	9,9	5	0,2	6	DZ-45x55x9.9-E2F
50	60	9,9	5	0,2	6	DZ-50x60x9.9-E2F
55	65	9,9	5	0,2	6	DZ-55x65x9.9-E2F
60	70	9,9	5	0,2	6	DZ-60x70x9.9-E2F
65	75	9,9	5	0,2	6	DZ-65x75x9.9-E2F
70	80	9,9	5	0,2	6	DZ-70x80x9.9-E2F
75	85	9,9	5	0,2	6	DZ-75x85x9.9-E2F
80	90	9,9	5	0,2	6	DZ-80x90x9.9-E2F
85	100	13,8	7,5	0,5	8,5	DZ-85x100x13.8-E2F
90	105	13,2	7,5	0,5	8,5	DZ-90x105x13.2-E2F
100	115	13,2	7,5	0,5	8,5	DZ-100x115x13.2-E2F
105	120	13,2	7,5	0,5	8,5	DZ-105x120x13.2-E2F

Other sizes are available on request

3.6 DZ profile rod seals, inch sizes d 0.187 – 3.25 in.

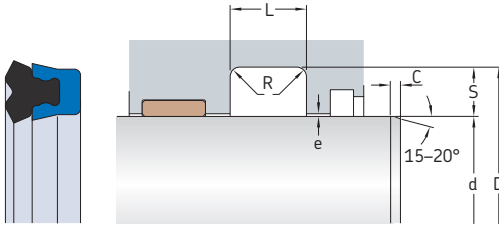

Maximum extrusion gap e

Radial depth	e_{\max} at 60 °C (140 °F) for pressures		
	2 300 psi	3 600 psi	5 800 psi
S			
in.	in.		
0.125	0.008	0.004	–
0.156 to 0.187	0.014	0.008	–
0.25	0.018	0.01	0.004
0.312 to 0.375	0.02	0.012	0.006
0.5	0.024	0.012	0.008

For additional information → page 34

Dimensions

d	Tolerance	D	Tolerance	L +0.01	S	R max.	C min.	Designation
in.								–
0.187	-0.001 -0.001	0.437 0.437	+0.002 +0.002	0.213 0.275	0.125 0.125	0.015 0.015	0.25 0.25	DZ125-187-187-E2F DZ125-187-250-E2F
0.375	-0.002	0.875	+0.003	0.413	0.25	0.02	0.312	DZ250-375-375-E2F
0.5	-0.001 -0.002	0.75 0.875	+0.002 +0.002	0.275 0.343	0.125 0.187	0.015 0.015	0.25 0.25	DZ125-500-250-E2F DZ187-500-312-E2F
0.625	-0.001	0.937	+0.002	0.275	0.156	0.015	0.25	DZ156-625-250-E2F
0.75	-0.001 -0.001 -0.002	1 1 1.125	+0.002 +0.002 +0.002	0.213 0.275 0.343	0.125 0.125 0.187	0.015 0.015 0.015	0.25 0.25 0.25	DZ125-750-187-E2F DZ125-750-250-E2F DZ187-750-312-E2F
0.875	-0.001	1.125	+0.002	0.275	0.125	0.015	0.25	DZ125-875-250-E2F
1	-0.001 -0.002	1.25 1.375	+0.002 +0.002	0.275 0.343	0.125 0.187	0.015 0.015	0.25 0.25	DZ125-1000-250-E2F DZ187-1000-312-E2F
1.125	-0.001 -0.002 -0.002	1.375 1.5 1.625	+0.002 +0.002 +0.003	0.275 0.343 0.413	0.125 0.187 0.25	0.015 0.015 0.02	0.25 0.25 0.312	DZ125-1125-250-E2F DZ187-1125-312-E2F DZ250-1125-375-E2F
1.187	-0.002	1.562	+0.002	0.343	0.187	0.015	0.25	DZ187-1187-312-E2F
1.25	-0.001 -0.002 -0.002 -0.002 -0.002	1.5 1.625 1.75 1.75 2	+0.002 +0.002 +0.003 +0.003 +0.005	0.275 0.343 0.413 0.618 0.688	0.125 0.187 0.25 0.25 0.375	0.015 0.015 0.02 0.02 0.03	0.25 0.25 0.312 0.312 0.5	DZ125-1250-250-E2F DZ187-1250-312-E2F DZ250-1250-375-E2F DZ250-1250-562-E2F DZ375-1250-625-E2F
1.375	-0.001 -0.002 -0.002	1.625 1.75 1.875	+0.002 +0.002 +0.003	0.343 0.343 0.413	0.125 0.187 0.25	0.015 0.015 0.02	0.25 0.25 0.312	DZ125-1375-312-E2F DZ187-1375-312-E2F DZ250-1375-375-E2F

Dimensions								Designation
d	Tolerance	D	Tolerance	L +0.01	S	R max.	C min.	
in.								-
1.5	-0.001	1.75	+0.002	0.275	0.125	0.015	0.25	DZ125-1500-250-E2F
	-0.001	1.812	+0.002	0.343	0.156	0.015	0.25	DZ156-1500-312-E2F
	-0.002	1.875	+0.002	0.343	0.187	0.015	0.25	DZ187-1500-312-E2F
	-0.002	1.875	+0.002	0.413	0.187	0.015	0.25	DZ187-1500-375-E2F
	-0.002	2	+0.003	0.413	0.25	0.02	0.312	DZ250-1500-375-E2F
	-0.002	2	+0.003	0.618	0.25	0.02	0.312	DZ250-1500-562-E2F
1.625	-0.002	2	+0.002	0.343	0.187	0.015	0.25	DZ187-1625-312-E2F
	-0.002	2	+0.002	0.413	0.187	0.015	0.25	DZ187-1625-375-E2F
	-0.002	2.125	+0.003	0.413	0.25	0.02	0.312	DZ250-1625-375-E2F
1.75	-0.001	2	+0.002	0.275	0.125	0.015	0.25	DZ125-1750-250-E2F
	-0.002	2.125	+0.002	0.343	0.187	0.015	0.25	DZ187-1750-312-E2F
	-0.002	2.125	+0.002	0.413	0.187	0.015	0.25	DZ187-1750-375-E2F
	-0.002	2.25	+0.003	0.413	0.25	0.02	0.312	DZ250-1750-375-E2F
	-0.002	2.5	+0.005	0.413	0.375	0.03	0.5	DZ375-1750-375-E2F
	-0.002	2.5	+0.005	0.825	0.375	0.03	0.5	DZ375-1750-750-E2F
1.875	-0.002	2.25	+0.002	0.343	0.187	0.015	0.25	DZ187-1875-312-E2F
2	-0.002	2.375	+0.002	0.343	0.187	0.015	0.25	DZ187-2000-312-E2F
	-0.002	2.375	+0.002	0.413	0.187	0.015	0.25	DZ187-2000-375-E2F
	-0.002	2.5	+0.003	0.413	0.25	0.02	0.312	DZ250-2000-375-E2F
	-0.002	2.5	+0.003	0.618	0.25	0.02	0.312	DZ250-2000-562-E2F
2.25	-0.002	2.625	+0.002	0.343	0.187	0.015	0.25	DZ187-2250-312-E2F
	-0.002	2.625	+0.002	0.413	0.187	0.015	0.25	DZ187-2250-375-E2F
	-0.002	2.75	+0.003	0.413	0.25	0.02	0.312	DZ250-2250-375-E2F
2.375	-0.002	2.75	+0.002	0.343	0.187	0.015	0.25	DZ187-2375-312-E2F
	-0.002	2.875	+0.003	0.413	0.25	0.02	0.312	DZ250-2375-375-E2F
2.5	-0.002	2.875	+0.002	0.343	0.187	0.015	0.25	DZ187-2500-312-E2F
	-0.002	2.875	+0.002	0.413	0.187	0.015	0.25	DZ187-2500-375-E2F
	-0.002	3	+0.003	0.413	0.25	0.02	0.312	DZ250-2500-375-E2F
	-0.002	3.125	+0.004	0.55	0.312	0.02	0.312	DZ312-2500-500-E2F
	-0.002	3.25	+0.005	0.688	0.375	0.03	0.5	DZ375-2500-625-E2F
2.625	-0.002	3.125	+0.003	0.413	0.25	0.02	0.312	DZ250-2625-375-E2F
2.75	-0.002	3.125	+0.002	0.343	0.187	0.015	0.25	DZ187-2750-312-E2F
	-0.002	3.25	+0.003	0.413	0.25	0.02	0.312	DZ250-2750-375-E2F
	-0.002	3.5	+0.005	0.688	0.375	0.03	0.5	DZ375-2750-625-E2F
2.875	-0.002	3.375	+0.003	0.413	0.25	0.02	0.312	DZ250-2875-375-E2F
3	-0.002	3.375	+0.002	0.343	0.187	0.015	0.25	DZ187-3000-312-E2F
	-0.002	3.375	+0.002	0.413	0.187	0.015	0.25	DZ187-3000-375-E2F
	-0.002	3.5	+0.003	0.413	0.25	0.02	0.312	DZ250-3000-375-E2F
	-0.002	3.5	+0.003	0.618	0.25	0.02	0.312	DZ250-3000-562-E2F
	-0.002	3.625	+0.004	0.55	0.312	0.02	0.312	DZ312-3000-500-E2F
	-0.002	3.75	+0.005	0.688	0.375	0.03	0.5	DZ375-3000-625-E2F
3.125	-0.002	3.75	+0.005	0.965	0.375	0.03	0.5	DZ375-3000-875-E2F
3.125	-0.002	3.625	+0.003	0.413	0.25	0.02	0.312	DZ250-3125-375-E2F
3.187	-0.002	3.562	+0.002	0.413	0.187	0.015	0.25	DZ187-3187-375-E2F
3.25	-0.002	3.625	+0.002	0.343	0.187	0.015	0.25	DZ187-3250-312-E2F
	-0.002	3.75	+0.003	0.413	0.25	0.02	0.312	DZ250-3250-375-E2F
	-0.002	3.875	+0.004	0.55	0.312	0.02	0.312	DZ312-3250-500-E2F
	-0.002	4	+0.005	0.688	0.375	0.03	0.5	DZ375-3250-625-E2F

3.6

3.6 DZ profile rod seals, inch sizes d 3.375 – 12 in.

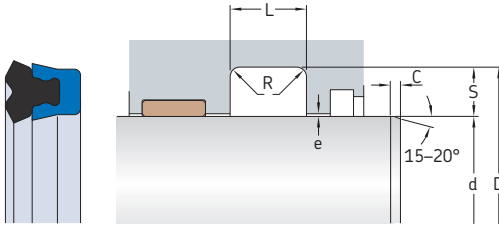

Maximum extrusion gap e

Radial depth	e _{max} at 60 °C (140 °F) for pressures		
	2 300 psi	3 600 psi	5 800 psi
S			
in.	in.		
0.125	0.008	0.004	–
0.156 to 0.187	0.014	0.008	–
0.25	0.018	0.01	0.004
0.312 to 0.375	0.02	0.012	0.006
0.5	0.024	0.012	0.008

For additional information → page 34

Dimensions

Designation

d	Tolerance	D	Tolerance	L +0.01	S	R max.	C min.	Designation
in.								–
3.375	-0.002 -0.002	3.875 4	+0.003 +0.004	0.413 0.55	0.25 0.312	0.02 0.02	0.312 0.312	DZ250-3375-375-E2F DZ312-3375-500-E2F
3.5	-0.002 -0.002 -0.002 -0.003	4 4.125 4.25 4.5	+0.003 +0.004 +0.005 +0.007	0.413 0.55 0.688 0.825	0.25 0.312 0.375 0.5	0.02 0.02 0.03 0.03	0.312 0.312 0.5 0.625	DZ250-3500-375-E2F DZ312-3500-500-E2F DZ375-3500-625-E2F DZ500-3500-750-E2F
3.625	-0.002 -0.002	4.375 4.375	+0.005 +0.005	0.688 0.965	0.375 0.375	0.03 0.03	0.5 0.5	DZ375-3625-625-E2F DZ375-3625-875-E2F
3.75	-0.002 -0.002 -0.002 -0.002 -0.002	4.25 4.25 4.375 4.375 4.5	+0.003 +0.003 +0.004 +0.004 +0.005	0.413 0.618 0.413 0.55 0.688	0.25 0.25 0.312 0.312 0.375	0.02 0.02 0.02 0.02 0.03	0.312 0.312 0.312 0.312 0.5	DZ250-3750-375-E2F DZ250-3750-562-E2F DZ312-3750-375-E2F DZ312-3750-500-E2F DZ375-3750-625-E2F
3.875	-0.002	4.375	+0.003	0.413	0.25	0.02	0.312	DZ250-3875-375-E2F
4	-0.002 -0.002 -0.002 -0.002 -0.002 -0.003	4.375 4.5 4.5 4.75 4.75 5	+0.002 +0.003 +0.003 +0.005 +0.005 +0.007	0.413 0.413 0.618 0.688 0.825 0.825	0.187 0.25 0.25 0.375 0.375 0.5	0.015 0.02 0.02 0.03 0.03 0.03	0.25 0.312 0.312 0.5 0.5 0.625	DZ187-4000-375-E2F DZ250-4000-375-E2F DZ250-4000-562-E2F DZ375-4000-625-E2F DZ375-4000-750-E2F DZ500-4000-750-E2F
4.25	-0.002 -0.002 -0.002	4.75 4.875 5	+0.003 +0.004 +0.005	0.413 0.618 0.688	0.25 0.312 0.375	0.02 0.02 0.03	0.312 0.312 0.5	DZ250-4250-375-E2F DZ312-4250-562-E2F DZ375-4250-625-E2F
4.5	-0.002 -0.002 -0.002 -0.002	5 5 5.25 5.25	+0.003 +0.003 +0.005 +0.005	0.413 0.618 0.688 0.825	0.25 0.25 0.375 0.375	0.02 0.02 0.03 0.03	0.312 0.312 0.5 0.5	DZ250-4500-375-E2F DZ250-4500-562-E2F DZ375-4500-625-E2F DZ375-4500-750-E2F
4.625	-0.002	5.125	+0.003	0.618	0.25	0.02	0.312	DZ250-4625-562-E2F
4.75	-0.002 -0.002 -0.002	5.125 5.25 5.5	+0.002 +0.003 +0.005	0.413 0.618 0.688	0.187 0.25 0.375	0.015 0.02 0.03	0.25 0.312 0.5	DZ187-4750-375-E2F DZ250-4750-562-E2F DZ375-4750-625-E2F

Dimensions								Designation
d	Tolerance	D	Tolerance	L +0.01	S	R max.	C min.	
in.								-
5	-0.002	5.5	+0.003	0.413	0.25	0.02	0.312	DZ250-5000-375-E2F
	-0.002	5.5	+0.003	0.618	0.25	0.02	0.312	DZ250-5000-562-E2F
	-0.002	5.75	+0.005	0.688	0.375	0.03	0.5	DZ375-5000-625-E2F
5.25	-0.002	5.75	+0.003	0.618	0.25	0.02	0.312	DZ250-5250-562-E2F
5.375	-0.002	5.875	+0.003	0.413	0.25	0.02	0.312	DZ250-5375-375-E2F
5.5	-0.002	5.875	+0.002	0.413	0.187	0.015	0.25	DZ187-5500-375-E2F
	-0.002	6	+0.003	0.618	0.25	0.02	0.312	DZ250-5500-562-E2F
	-0.002	6.25	+0.005	0.688	0.375	0.03	0.5	DZ375-5500-625-E2F
5.75	-0.002	6.25	+0.003	0.413	0.25	0.02	0.312	DZ250-5750-375-E2F
	-0.002	6.5	+0.005	0.688	0.375	0.03	0.5	DZ375-5750-625-E2F
6	-0.002	6.5	+0.003	0.413	0.25	0.02	0.312	DZ250-6000-375-E2F
	-0.002	6.5	+0.003	0.618	0.25	0.02	0.312	DZ250-6000-562-E2F
	-0.002	6.75	+0.005	0.688	0.375	0.03	0.5	DZ375-6000-625-E2F
	-0.003	7	+0.007	0.825	0.5	0.03	0.625	DZ500-6000-750-E2F
6.375	-0.002	6.875	+0.003	0.55	0.25	0.02	0.312	DZ250-6375-500-E2F
6.5	-0.002	7	+0.003	0.413	0.25	0.02	0.312	DZ250-6500-375-E2F
	-0.002	7	+0.003	0.618	0.25	0.02	0.312	DZ250-6500-562-E2F
	-0.002	7.25	+0.005	0.688	0.375	0.03	0.5	DZ375-6500-625-E2F
6.75	-0.002	7.25	+0.003	0.618	0.25	0.02	0.312	DZ250-6750-562-E2F
7	-0.002	7.5	+0.003	0.413	0.25	0.02	0.312	DZ250-7000-375-E2F
	-0.002	7.75	+0.005	0.688	0.375	0.03	0.5	DZ375-7000-625-E2F
	-0.003	8	+0.007	0.825	0.5	0.03	0.625	DZ500-7000-750-E2F
7.25	-0.002	7.75	+0.003	0.55	0.25	0.02	0.312	DZ250-7250-500-E2F
7.5	-0.002	8.25	+0.005	0.688	0.375	0.03	0.5	DZ375-7500-625-E2F
7.75	-0.002	8.5	+0.005	0.55	0.375	0.03	0.5	DZ375-7750-500-E2F
8	-0.002	8.75	+0.005	0.688	0.375	0.03	0.5	DZ375-8000-625-E2F
	-0.003	9	+0.007	0.825	0.5	0.03	0.625	DZ500-8000-750-E2F
8.125	-0.002	8.625	+0.003	0.413	0.25	0.02	0.312	DZ250-8125-375-E2F
	-0.002	8.625	+0.003	0.55	0.25	0.02	0.312	DZ250-8125-500-E2F
	-0.002	8.625	+0.003	0.618	0.25	0.02	0.312	DZ250-8125-562-E2F
8.25	-0.002	9	+0.005	0.688	0.375	0.03	0.5	DZ375-8250-625-E2F
8.5	-0.003	9.5	+0.007	0.825	0.5	0.03	0.625	DZ500-8500-750-E2F
8.875	-0.002	9.5	+0.004	0.55	0.312	0.02	0.312	DZ312-8875-500-E2F
9	-0.002	9.75	+0.005	0.688	0.375	0.03	0.5	DZ375-9000-625-E2F
	-0.003	10	+0.007	0.825	0.5	0.03	0.625	DZ500-9000-750-E2F
9.25	-0.002	10	+0.005	0.618	0.375	0.03	0.5	DZ375-9250-562-E2F
10.5	-0.002	11.25	+0.005	0.688	0.375	0.03	0.5	DZ375-10500-625-E2F
10.75	-0.002	11.5	+0.005	0.688	0.375	0.03	0.5	DZ375-10750-625-E2F
11	-0.003	12	+0.007	0.825	0.5	0.03	0.625	DZ500-11000-750-E2F
12	-0.003	13	+0.007	0.825	0.5	0.03	0.625	DZ500-12000-750-E2F

Other sizes are available on request

3.7 DZR profile rod seals, metric sizes d 40 – 150 mm

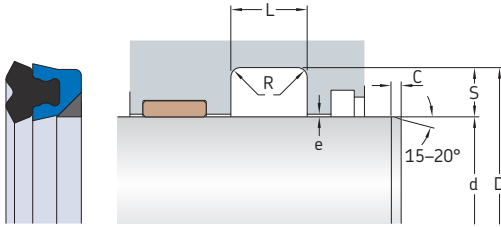

Maximum extrusion gap e

Radial depth S	e_{\max} at 80 °C (175 °F) for pressures			
	160 bar	250 bar	400 bar	690 bar
mm	mm			
5	0,55	0,35	0,2	0,1
7,5	0,8	0,5	0,3	0,15
10 to 11	1,1	0,75	0,45	0,2

For additional information → page 34

3.7

Dimensions

d f8 or h9	D H10	L +0,2	S	R max.	C min.
---------------	----------	-----------	---	-----------	-----------

mm

Designation

-

40	50	8	5	0,2	6	DZR-40x50x8-E2E
50	60	8	5	0,2	6	DZR-50x60x8-E2E
56	71	11,7	7,5	0,5	8,5	DZR-56x71x11.7-E2E
63	78	11,7	7,5	0,5	8,5	DZR-63x78x11.7-E2E
75	95	16,5	10	0,8	11	DZR-75x95x16.5-E2D
85	100	13,8	7,5	0,5	8,5	DZR-85x100x13.8-E2E
110	125	12,5	7,5	0,5	8,5	DZR-110x125x12.5-E2D
150	172	16,5	11	0,8	13	DZR-150x172x16.5-E2D

Other sizes are available on request

3.7 DZR profile rod seals, inch sizes d 1.25 – 12 in.

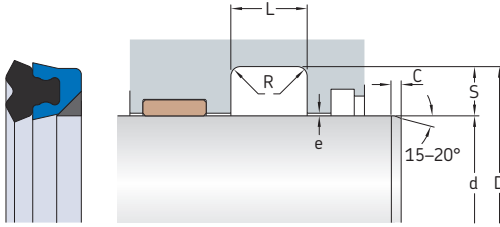

Maximum extrusion gap e

Radial depth S	e_{\max} at 80 °C (175 °F)			
	for pressures			
	2 300	3 600	5 800	10 000
	psi	psi	psi	psi
in.	in.			
0.187	0.021	0.013	0.008	0.005
0.25	0.028	0.018	0.011	0.007
0.312	0.044	0.028	0.017	0.01
0.375	0.044	0.028	0.017	0.01
0.5	0.059	0.038	0.023	0.014

For additional information → page 34

Dimensions

Designation

d	Tolerance	D	Tolerance	L +0.01	S	R max.	C min.	
in.								-
1.25	-0.002 -0.002	1.625 1.750	+0.002 +0.003	0.343 0.413	0.187 0.25	0.015 0.02	0.250 0.312	DZR187-1250-312-E2E
1.5	-0.002 -0.002	1.875 2.000	+0.002 +0.003	0.343 0.413	0.187 0.25	0.015 0.02	0.250 0.312	DZR187-1500-312-E2E DZR250-1500-375-E2E
1.75	-0.002	2.250	+0.003	0.413	0.25	0.02	0.312	DZR250-1750-375-E2E
2	-0.002 -0.002	2.500 2.750	+0.003 +0.005	0.413 0.688	0.25 0.375	0.02 0.03	0.312 0.500	DZR250-2000-375-E2E DZR375-2000-625-E2E
2.25	-0.002	2.750	+0.003	0.413	0.25	0.02	0.312	DZR250-2250-375-E2E
2.375	-0.002	2.875	+0.003	0.413	0.25	0.02	0.312	DZR250-2375-375-E2D
2.5	-0.002	3.000	+0.003	0.413	0.25	0.02	0.312	DZR250-2500-375-E2E
2.625	-0.002	3.125	+0.003	0.413	0.25	0.02	0.312	DZR250-2625-375-E2E
2.75	-0.002	3.250	+0.003	0.413	0.25	0.02	0.312	DZR250-2750-375-E2E
3	-0.002 -0.002 -0.002	3.374 3.500 3.750	+0.003 +0.003 +0.005	0.413 0.413 0.688	0.187 0.25 0.375	0.015 0.02 0.03	0.250 0.312 0.500	DZR187-3000-375-E2D DZR250-3000-375-E2E DZR375-3000-625-E2E
3.5	-0.002 -0.002	4.000 4.250	+0.003 +0.005	0.413 0.688	0.25 0.375	0.02 0.03	0.312 0.500	DZR250-3500-375-E2E DZR375-3500-625-E2E
3.625	-0.002 -0.002	4.125 4.375	+0.003 +0.005	0.413 0.688	0.25 0.375	0.02 0.03	0.312 0.500	DZR250-3625-375-E2E DZR375-3625-625-E2E
3.75	-0.002	4.250	+0.003	0.413	0.25	0.02	0.312	DZR250-3750-375-E2E
3.875	-0.002	4.375	+0.003	0.413	0.25	0.02	0.312	DZR250-3875-375-E2D
4	-0.002 -0.002 -0.002 -0.002 -0.002	4.500 4.500 4.625 4.625 4.750	+0.003 +0.003 +0.004 +0.004 +0.005	0.413 0.618 0.550 0.618 0.688	0.25 0.25 0.312 0.312 0.375	0.02 0.02 0.02 0.02 0.03	0.312 0.312 0.312 0.312 0.500	DZR250-4000-375-E2E DZR250-4000-562-E2E DZR312-4000-500-E2E DZR312-4000-562-E2E DZR375-4000-625-E2E

Dimensions								Designation
d	Tolerance	D	Tolerance	L +0.01	S	R max.	C min.	
in.								-
4.25	-0.002	5.000	+0.005	0.688	0.375	0.03	0.500	DZR375-4250-625-E2E
4.375	-0.002	4.875	+0.003	0.413	0.25	0.02	0.312	DZR250-4375-375-E2D
4.5	-0.002	5.000	+0.003	0.413	0.25	0.02	0.312	DZR250-4500-375-E2E
	-0.002	5.250	+0.005	0.688	0.375	0.03	0.500	DZR375-4500-625-E2E
4.875	-0.002	5.375	+0.003	0.413	0.25	0.02	0.312	DZR250-4875-375-E2D
5	-0.002	5.500	+0.003	0.413	0.25	0.02	0.312	DZR250-5000-375-E2E
	-0.002	5.500	+0.003	0.618	0.25	0.02	0.312	DZR250-5000-562-E2E
	-0.002	5.750	+0.005	0.688	0.375	0.03	0.500	DZR375-5000-625-E2E
5.25	-0.002	6.000	+0.005	0.688	0.375	0.03	0.500	DZR375-5250-625-E2E
5.5	-0.002	6.000	+0.003	0.413	0.25	0.02	0.312	DZR250-5500-375-E2E
	-0.002	6.250	+0.005	0.688	0.375	0.03	0.500	DZR375-5500-625-E2E
6	-0.002	6.750	+0.005	0.688	0.375	0.03	0.500	DZR375-6000-625-E2E
	-0.003	7.000	+0.007	0.825	0.5	0.03	0.625	DZR500-6000-750-E2E
6.5	-0.002	7.250	+0.005	0.688	0.375	0.03	0.500	DZR375-6500-625-E2E
	-0.003	7.500	+0.007	0.825	0.5	0.03	0.625	DZR500-6500-750-E2E
6.75	-0.002	7.500	+0.005	0.688	0.375	0.03	0.500	DZR375-6750-625-E2E
7	-0.002	7.750	+0.005	0.688	0.375	0.03	0.500	DZR375-7000-625-E2E
	-0.003	8.000	+0.007	0.825	0.5	0.03	0.625	DZR500-7000-750-E2E
7.25	-0.002	8.000	+0.005	0.688	0.375	0.03	0.500	DZR375-7250-625-E2D
7.5	-0.002	8.250	+0.005	0.688	0.375	0.03	0.500	DZR375-7500-625-E2D
7.75	-0.002	8.500	+0.005	0.688	0.375	0.03	0.500	DZR375-7750-625-E2D
7.875	-0.002	8.625	+0.005	0.688	0.375	0.03	0.500	DZR375-7875-625-E2D
8	-0.002	8.750	+0.005	0.688	0.375	0.03	0.500	DZR375-8000-625-E2E
	-0.003	9.000	+0.007	0.825	0.5	0.03	0.625	DZR500-8000-750-E2E
8.5	-0.003	9.500	+0.007	0.825	0.5	0.03	0.625	DZR500-8500-750-E2E
9	-0.002	9.750	+0.005	0.688	0.375	0.03	0.500	DZR375-9000-625-E2D
11	-0.002	11.750	+0.005	0.688	0.375	0.03	0.500	DZR375-11000-625-E2D
	-0.003	12.000	+0.007	0.825	0.5	0.03	0.625	DZR500-11000-750-E2D
12	-0.002	12.750	+0.005	0.688	0.375	0.03	0.500	DZR375-12000-625-E2D

Other sizes are available on request

RBB profile data



Material codes	Sealing ring: metric sizes → U-1029 inch sizes → U-1023 Anti-extrusion ring: metric sizes → P-2518 inch sizes → 707 For additional information → page 26
Pressure	Up to 690 bar (10 000 psi)
Speed	Up to 1 m/s (3.2 ft/s)
Temperature range	<p> ■ Extreme low temperature range: may be intermittently exposed (e.g. cold start-up) without seal damage, but seal performance may be compromised while in this range ■ Temperatures below the recommended operating range: seal performance depends on system design (precision guiding arrangement recommended) ■ Recommended operating temperature range for this profile and material ■ Temperatures above the recommended operating range: acceptable only with reduced pressure and/or speed ■ Extreme high temperature range: only occasional short-term exposure (e.g. cylinder in curing oven of a powder coating process) </p>
Dimension standards	Some metric sizes fit seal housings in accordance with ISO 7425-2.
Counter-surface	→ page 22

Maximum values of application parameters (e.g. pressure, speed, temperature, e-gap) should not be applied continuously nor simultaneously.

3.8 RBB profile buffer seals, metric sizes d 25 – 110 mm

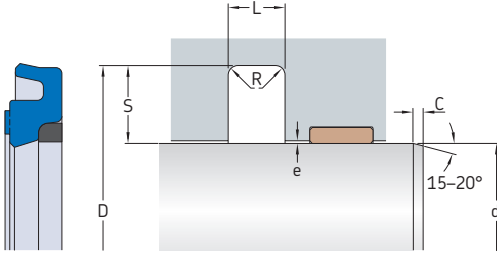

Maximum extrusion gap e

Radial depth S	e_{\max} at 80 °C (175 °F) for pressures			
	160 bar	250 bar	400 bar	690 bar
mm	mm			
5,35	0,6	0,4	0,25	0,1
7,55 to 7,75	0,8	0,55	0,35	0,15

For additional information → [page 34](#)

Dimensions

d ¹⁾	D H9	L +0,2	S	R max.	C min.
-----------------	---------	-----------	---	-----------	-----------

mm

Designation

–

25	35,7	4,2	5,35	0,55	6	RBB-25x35.7x4.2-J0S
30	40,7	4,2	5,35	0,55	6	RBB-30x40.7x4.2-J0S
35	45,7	4,2	5,35	0,55	6	RBB-35x45.7x4.2-J0S
40	55,1	6,3	7,55	0,7	8	RBB-40x55.1x6.3-J0S
50	65,1	6,3	7,55	0,7	8	RBB-50x65.1x6.3-J0S
55	70,1	6,3	7,55	0,7	8	RBB-55x70.1x6.3-J0S
	70,5	6,3	7,75	0,7	8	RBB-55x70.5x6.3-J0S
60	75,1	6,3	7,55	0,7	8	RBB-60x75.1x6.3-J0S
65	80,1	6,3	7,55	0,7	8	RBB-65x80.1x6.3-J0S
	80,5	6,3		0,7	8	RBB-65x80.5x6.3-J0S
70	85,1	6,3	7,55	0,7	8	RBB-70x85.1x6.3-J0S
	85,5	6,3	7,75	0,7	8	• RBB-70x85.5x6.3-J0S
75	90,1	6,3	7,55	0,7	8	RBB-75x90.1x6.3-J0S
	90,5	6,3	7,75	0,7	8	RBB-75x90.5x6.3-J0S
80	95,1	6,3	7,55	0,7	8	RBB-80x95.1x6.3-J0S
85	100,1	6,3	7,55	0,7	8	RBB-85x100.1x6.3-J0S
90	105,1	6,3	7,55	0,7	8	RBB-90x105.1x6.3-J0S
	105,5	6,3	7,75	0,7	8	• RBB-90x105.5x6.3-J0S
95	110,1	6,3	7,55	0,7	8	RBB-95x110.1x6.3-J0S
	110,5	6,3	7,75	0,7	8	RBB-95x110.5x6.3-J0S
100	115,1	6,3	7,55	0,7	8	RBB-100x115.1x6.3-J0S
105	120,1	6,3	7,55	0,7	8	RBB-105x120.1x6.3-J0S
110	125,1	6,3	7,55	0,7	8	RBB-110x125.1x6.3-J0S

¹⁾ Tolerance is determined by the rod seal

• Seal housing dimensions in accordance with ISO 7425-2

3.8 RBB profile buffer seals, metric sizes d 115 – 170 mm

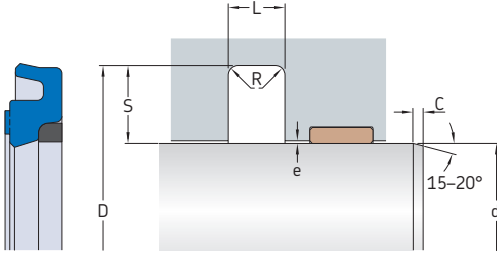

Maximum extrusion gap e

Radial depth S	e_{\max} at 80 °C (175 °F) for pressures			
	160 bar	250 bar	400 bar	690 bar
mm	mm			
5,35	0,6	0,4	0,25	0,1
7,55 to 7,75	0,8	0,55	0,35	0,15

For additional information → [page 34](#)

Dimensions

d ¹⁾	D H9	L +0,2	S	R max.	C min.
-----------------	---------	-----------	---	-----------	-----------

mm

Designation

–

115	130,1	6,3	7,55	0,7	8	RBB-115x130.1x6.3-J0S
120	135,1	6,3	7,55	0,7	8	RBB-120x135.1x6.3-J0S
125	140,1	6,3	7,55	0,7	8	RBB-125x140.1x6.3-J0S
130	145,1	6,3	7,55	0,7	8	RBB-130x145.1x6.3-J0S
140	155,1	6,3	7,55	0,7	8	RBB-140x155.1x6.3-J0S
150	165,1	6,3	7,55	0,7	8	RBB-150x165.1x6.3-J0S
170	185,1	6,3	7,55	0,7	8	RBB-170x185.1x6.3-J0S

Other sizes are available on request

¹⁾ Tolerance is determined by the rod seal

3.8 RBB profile buffer seals, inch sizes d 2 – 8 in.

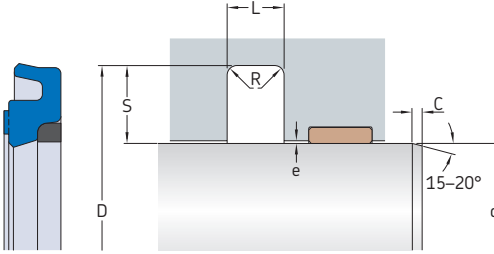

Maximum extrusion gap e

Radial depth S	Series	e_{\max} at 80 °C (175 °F) for pressures			
		2 300 psi	3 600 psi	5 800 psi	10 000 psi
in.	–	in.			

0.166 to 0.212	RBB2	0.019	0.012	0.008	0.004
0.247 to 0.308	RBB3	0.029	0.019	0.012	0.005
0.32 to 0.415	RBB4	0.037	0.024	0.015	0.007

For additional information → page 34

3.8

Dimensions

d	Tolerance	D	Tolerance	L +0.01	S	R max.	C min.	Designation
in.								–
2	–0.004	2.616	+0.005	0.247	0.308	0.028	0.312	RBB3-2000-E6T
2.25	–0.003	2.674	+0.004	0.166	0.212	0.022	0.25	RBB2-2250-E6T
2.5	–0.003	2.924	+0.004	0.166	0.212	0.022	0.25	RBB2-2500-E6T
	–0.004	3.116	+0.005	0.247	0.308	0.028	0.312	RBB3-2500-E6T
2.75	–0.004	3.366	+0.005	0.247	0.308	0.028	0.312	RBB3-2750-E6T
3	–0.004	3.616	+0.005	0.247	0.308	0.028	0.312	RBB3-3000-E6T
3.5	–0.004	4.116	+0.005	0.247	0.308	0.028	0.312	RBB3-3500-E6T
4	–0.004	4.616	+0.005	0.247	0.308	0.028	0.312	RBB3-4000-E6T
4.5	–0.004	5.116	+0.005	0.247	0.308	0.028	0.312	RBB3-4500-E6T
4.75	–0.004	5.366	+0.005	0.247	0.308	0.028	0.312	RBB3-4750-E6T
5	–0.004	5.616	+0.005	0.247	0.308	0.028	0.312	RBB3-5000-E6T
5.5	–0.004	6.116	+0.005	0.247	0.308	0.028	0.312	RBB3-5500-E6T
6	–0.004	6.616	+0.005	0.247	0.308	0.028	0.312	RBB3-6000-E6T
6.5	–0.004	7.116	+0.005	0.247	0.308	0.028	0.312	RBB3-6500-E6T
7	–0.004	7.616	+0.005	0.247	0.308	0.028	0.312	RBB3-7000-E6T
7.25	–0.004	7.866	+0.005	0.247	0.308	0.028	0.312	RBB3-7250-E6T
8	–0.004	8.616	+0.005	0.247	0.308	0.028	0.312	RBB3-8000-E6T

Other sizes are available on request

S9B profile data



Material codes	O-ring energizer: N70/6052 or A-8501 Slide ring: X-ECOPUR or 741 For additional information → page 26
Pressure	X-ECOPUR slide ring → up to 600 bar (8 700 psi) PTFE 741 slide ring → up to 400 bar (5 800 psi)
Speed	Up to 2 m/s (6.5 ft/s)
Temperature range	<p>With X-ECOPUR slide ring:</p> <p>With 741 slide ring:</p> <ul style="list-style-type: none"> ■ Extreme low temperature range: may be intermittently exposed (e.g. cold start-up) without seal damage, but seal performance may be compromised while in this range ■ Temperatures below the recommended operating range: seal performance depends on system design (precision guiding arrangement recommended) ■ Recommended operating temperature range for this profile and these materials ■ Temperatures above the recommended operating range: acceptable only with reduced pressure, speed, and/or e-gap ■ Extreme high temperature range: only occasional short-term exposure (e.g. cylinder in curing oven of a powder coating process)
Dimension standards	Some metric sizes fit seal housings in accordance with ISO 7425-2 or ISO 3320.
Counter-surface	→ page 22

Maximum values of application parameters (e.g. pressure, speed, temperature, e-gap) should not be applied continuously nor simultaneously.

3.9 S9B profile buffer seals, metric sizes d 6 – 18 mm

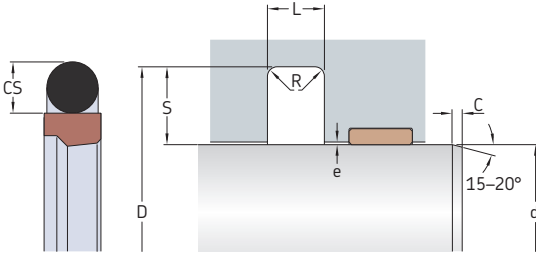

Maximum extrusion gap e with X-ECOPUR slide ring

Radial depth S	e_{\max} at 80 °C (175 °F) for pressures			
	160 bar	250 bar	400 bar	600 bar
mm	mm			
2,45 to 2,5	0,3	0,25	0,2	0,1
3,5 to 3,75	0,4	0,3	0,2	0,1
5,35 to 5,5	0,5	0,4	0,3	0,2
7,55 to 7,75	0,5	0,4	0,3	0,2
10,25 to 12,25	0,7	0,5	0,4	0,2

For additional information → page 34

Maximum extrusion gap e with 741 slide ring

Radial depth S	e_{\max} at 80 °C (175 °F) for pressures		
	160 bar	250 bar	400 bar
mm	mm		
2,45 to 2,5	0,25	0,2	0,15
3,5 to 3,75	0,35	0,25	0,15
5,35 to 5,5	0,4	0,3	0,2
7,55 to 7,75	0,5	0,35	0,25
10,25 to 12,25	0,6	0,45	0,35

For additional information → page 34

Dimensions

d ¹⁾	D H9	L +0,2	S	R max.	C min.	CS nom.
-----------------	---------	-----------	---	-----------	-----------	------------

mm

Designations

With slide ring made of
X-ECOPUR

741

6	11	2,2	2,5	0,5	3,5	1,78	• S9B-6x11x2.2	S9B-6x11x2.2-AD1
8	13	2,2	2,5	0,5	3,5	1,78	• S9B-8x13x2.2	S9B-8x13x2.2-AD1
	15,3	3,2	3,65	0,6	3,5	2,62	▲ S9B-8x15.3x3.2	S9B-8x15.3x3.2-AD1
10	15	2,2	2,5	0,5	3,5	1,78	• S9B-10x15x2.2	S9B-10x15x2.2-AD1
	17,3	3,2	3,65	0,6	3,5	2,62	▲ S9B-10x17.3x3.2	S9B-10x17.3x3.2-AD1
12	17	2,2	2,5	0,5	3,5	1,78	• S9B-12x17x2.2	S9B-12x17x2.2-AD1
	19,5	3,2	3,75	0,5	3,5	2,62	• S9B-12x19.5x3.2	S9B-12x19.5x3.2-AD1
14	19	2,2	2,5	0,5	3,5		• S9B-14x19x2.2	S9B-14x19x2.2-AD1
	21,3	3,2	3,65	0,6	3,5	2,62	▲ S9B-14x21,3x3,2	S9B-14x21,3x3,2-AD1
	21,5	3,2	3,75	0,5	3,5	2,62	• S9B-14x21.5x3.2	S9B-14x21.5x3.2-AD1
16	23,3	3,2	3,65	0,6	3,5	2,62	▲ S9B-16x23.3x3.2	S9B-16x23.3x3.2-AD1
	23,5	3,2	3,75	0,5	3,5	2,62	• S9B-16x23.5x3.2	S9B-16x23.5x3.2-AD1
18	25,3	3,2	3,65	0,6	3,5	2,62	▲ S9B-18x25.3x3.2	S9B-18x25.3x3.2-AD1
	25,5	3,2	3,75	0,5	3,5	2,62	• S9B-18x25.5x3.2	S9B-18x25.5x3.2-AD1

¹⁾ Tolerance is determined by the rod seal

• Dimensions in accordance with ISO 7425-2

▲ Dimensions in accordance with ISO 3320

3.9 S9B profile buffer seals, metric sizes d 20 – 360 mm

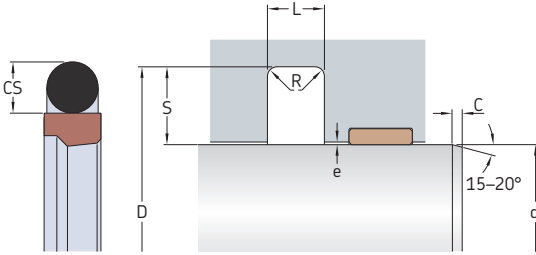

Maximum extrusion gap e with X-ECOPUR slide ring

Radial depth S	e_{\max} at 80 °C (175 °F) for pressures			
	160 bar	250 bar	400 bar	600 bar
mm	mm			
2,45 to 2,5	0,3	0,25	0,2	0,1
3,5 to 3,75	0,4	0,3	0,2	0,1
5,35 to 5,5	0,5	0,4	0,3	0,2
7,55 to 7,75	0,5	0,4	0,3	0,2
10,25 to 12,25	0,7	0,5	0,4	0,2

For additional information → page 34

Maximum extrusion gap e with 741 slide ring

Radial depth S	e_{\max} at 80 °C (175 °F) for pressures		
	160 bar	250 bar	400 bar
mm	mm		
2,45 to 2,5	0,25	0,2	0,15
3,5 to 3,75	0,35	0,25	0,15
5,35 to 5,5	0,4	0,3	0,2
7,55 to 7,75	0,5	0,35	0,25
10,25 to 12,25	0,6	0,45	0,35

For additional information → page 34

Dimensions

d ¹⁾	D	L	S	R	C	CS
	H9	+0,2		max.	min.	nom.

mm

Designations

With slide ring made of
X-ECOPUR

741

20	27,5	3,2	3,5	0,5	4,5	2,62	• S9B-20x27.5x3.2	S9B-20x27.5x3.2-AD1
	30,7	4,2	5,35	1	4,5	3,53	▲ S9B-20x30.7x4.2	S9B-20x30.7x4.2-AD1
	31	4,2	5,5	0,5	4,5	3,53	• S9B-20x31x4.2	S9B-20x31x4.2-AD1
22	29,5	3,2	3,75	0,5	4,5	2,62	• S9B-22x29.5x3.2	S9B-22x29.5x3.2-AD1
	33	4,2	5,5	0,5	4,5	3,53	• S9B-22x33x4.2	S9B-22x33x4.2-AD1
25	32,5	3,2	3,75	0,5	4,5	2,62	• S9B-25x32.5x3.2	S9B-25x32.5x3.2-AD1
	35,7	4,2	5,35	1	4,5	3,53	▲ S9B-25x35.7x4.2	S9B-25x35.7x4.2-AD1
	36	4,2	5,5	0,5	4,5	3,53	• S9B-25x36x4.2	S9B-25x36x4.2-AD1
28	38,7	4,2	5,35	1	4,5	3,53	▲ S9B-28x38.7x4.2	S9B-28x38.7x4.2-AD1
	39	4,2	5,5	0,5	4,5	3,53	• S9B-28x39x4.2	S9B-28x39x4.2-AD1
32	42,7	4,2	5,35	1	4,5	3,53	▲ S9B-32x42.7x4.2	S9B-32x42.7x4.2-AD1
	43	4,2	5,5	0,5	4,5	3,53	• S9B-32x43x4.2	S9B-32x43x4.2-AD1
35	45,7	4,2	5,35	1	4,5	3,53	S9B-35x45.7x4.2	S9B-35x45.7x4.2-AD1
36	46,7	4,2	5,35	1	4,5	3,53	▲ S9B-36x46.7x4.2	S9B-36x46.7x4.2-AD1
	47	4,2	5,5	0,5	4,5	3,53	• S9B-36x47x4.2	S9B-36x47x4.2-AD1

¹⁾ Tolerance is determined by the rod seal

• Dimensions in accordance with ISO 7425-2

▲ Dimensions in accordance with ISO 3320

Dimensions							Designations		741
d ¹⁾	D H9	L +0,2	S	R max.	C min.	CS nom.	With slide ring made of X-ECOPUR		
mm							-		
40	51	4,2	5,5	0,5	5	3,53	•	S9B-40x51x4.2	S9B-40x51x4.2-AD1
	55,1	6,3	7,55	1,3	5	5,33	▲	S9B-40x55.1x6.3	S9B-40x55.1x6.3-AD1
45	56	4,2	5,5	0,5	5	3,53	•	S9B-45x56x4.2	S9B-45x56x4.2-AD1
	60,1	6,3	7,55	1,3	5	5,33	▲	S9B-45x60.1x6.3	S9B-45x60.1x6.3-AD1
50	61	4,2	5,5	0,5	5	3,53	•	S9B-50x61x4.2	S9B-50x61x4.2-AD1
	65,1	6,3	7,55	1,3	5	5,33	▲	S9B-50x65.1x6.3	S9B-50x65.1x6.3-AD1
56	67	4,2	5,5	0,5	5	3,53	•	S9B-56x67x4.2	S9B-56x67x4.2-AD1
	71,5	6,3	7,75	0,9	5	5,33	•	S9B-56x71.5x6.3	S9B-56x71.5x6.3-AD1
55	70,1	6,3	7,55	1,3	5	5,33		S9B-55x70.1x6.3	S9B-55x70.1x6.3-AD1
63	74	4,2	5,5	0,5	5	3,53	•	S9B-63x74x4.2	S9B-63x74x4.2-AD1
	78,1	6,3	7,55	1,3	5	5,33	▲	S9B-63x78.1x6.3	S9B-63x78.1x6.3-AD1
	78,5	6,3	7,75	0,9	5	5,33	•	S9B-63x78.5x6.3	S9B-63x78.5x6.3-AD1
70	85,5	6,3	7,75	0,9	5	5,33	•	S9B-70x85.5x6.3	S9B-70x85.5x6.3-AD1
75	90,1	6,3	7,55	1,3	5	5,33		S9B-75x90.1x6.3	S9B-75x90.1x6.3-AD1
80	95,1	6,3	7,55	1,3	5	5,33	▲	S9B-80x95.1x6.3	S9B-80x95.1x6.3-AD1
	95,5	6,3	7,75	0,9	5	5,33	•	S9B-80x95.5x6.3	S9B-80x95.5x6.3-AD1
90	105,1	6,3	7,55	1,3	5	5,33	▲	S9B-90x105.1x6.3	S9B-90x105.1x6.3-AD1
	105,5	6,3	7,75	0,9	5	5,33	•	S9B-90x105.5x6.3	S9B-90x105.5x6.3-AD1
100	115,1	6,3	7,55	1,3	5	5,33	▲	S9B-100x115.1x6.3	S9B-100x115.1x6.3-AD1
	115,5	6,3	7,75	0,9	5	5,33	•	S9B-100x115.5x6.3	S9B-100x115.5x6.3-AD1
110	125,1	6,3	7,55	1,3	5	5,33	▲	S9B-110x125.1x6.3	S9B-110x125.1x6.3-AD1
	125,5	6,3	7,75	0,9	5	5,33	•	S9B-110x125.5x6.3	S9B-110x125.5x6.3-AD1
125	140,1	6,3	7,55	1,3	5	5,33	▲	S9B-125x140.1x6.3	S9B-125x140.1x6.3-AD1
	140,5	6,3	7,75	0,9	5	5,33	•	S9B-125x140.5x6.3	S9B-125x140.5x6.3-AD1
140	155,1	6,3	7,55	1,3	5	5,33	▲	S9B-140x155.1x6.3	S9B-140x155.1x6.3-AD1
	155,5	6,3	7,75	0,9	5	5,33	•	S9B-140x155.5x6.3	S9B-140x155.5x6.3-AD1
160	175,1	6,3	7,55	1,3	5	5,33	▲	S9B-160x175.1x6.3	S9B-160x175.1x6.3-AD1
	175,5	6,3	7,75	0,9	5	5,33	•	S9B-160x175.5x6.3	S9B-160x175.5x6.3-AD1
	181	8,1	10,5	0,9	5	7,0	•	S9B-160x181x8.1	S9B-160x181x8.1-AD1
180	195,1	6,3	7,55	1,3	5	5,33	▲	S9B-180x195.1x6.3	S9B-180x195.1x6.3-AD1
	195,5	6,3	7,75	0,9	5	5,33	•	S9B-180x195.5x6.3	S9B-180x195.5x6.3-AD1
	201	8,1	10,5	0,9	5	7,0	•	S9B-180x201x8.1	S9B-180x201x8.1-AD1
200	215,1	6,3	7,55	1,3	5	5,33		S9B-200x215.1x6.3	S9B-200x215.1x6.3-AD1
	221	8,1	10,5	0,9	5	7,0	•	S9B-200x221x8.1	S9B-200x221x8.1-AD1
220	241	8,1	10,5	0,9	6	7,0	•	S9B-220x241x8.1	S9B-220x241x8.1-AD1
240	260,5	8,1	10,25	1,8	6	7,0		S9B-240x260.5x8.1	S9B-240x260.5x8.1-AD1
250	271	8,1	10,5	0,9	6	7,0	•	S9B-250x271x8.1	S9B-250x271x8.1-AD1
280	304,5	8,1	12,25	0,9	6	7,0	•	S9B-280x304.5x8.1	S9B-280x304.5x8.1-AD1
320	344,5	8,1	12,25	0,9	6	7,0	•	S9B-320x344.5x8.1	S9B-320x344.5x8.1-AD1
360	384,5	8,1	12,25	0,9	6	7,0	•	S9B-360x384.5x8.1	S9B-360x384.5x8.1-AD1

Other sizes are available on request

¹⁾ Tolerance is determined by the rod seal
 • Dimensions in accordance with ISO 7425-2
 ▲ Dimensions in accordance with ISO 3320



3.9 S9B profile buffer seals, inch sizes d 1 – 10 in.

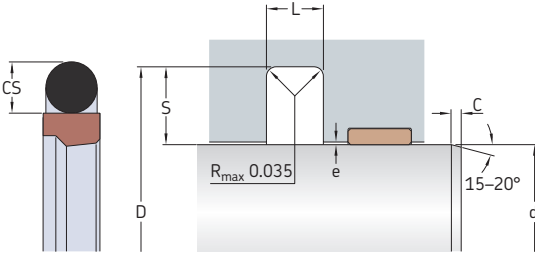

Maximum extrusion gap e with X-ECOPUR slide ring

Radial depth S	Series	e_{\max} at 80 °C (175 °F) for pressures			
		2 300 psi	3 600 psi	5 800 psi	8 700 psi
in.	-	in.			
0.149	S9B1	0.016	0.012	0.008	0.004
0.212	S9B2	0.02	0.016	0.012	0.008
0.308	S9B3	0.02	0.016	0.012	0.008
0.415	S9B4	0.028	0.02	0.016	0.008

For additional information → page 34

Maximum extrusion gap e with 741 slide ring

Radial depth S	Series	e_{\max} at 80 °C (175 °F) for pressures		
		2 300 psi	3 600 psi	5 800 psi
in.	-	in.		
0.149	S9B1	0.014	0.01	0.006
0.212	S9B2	0.016	0.012	0.008
0.308	S9B3	0.02	0.014	0.01
0.415	S9B4	0.024	0.018	0.014

For additional information → page 34

Dimensions

d	Tolerance	D	Tolerance	L +0.01	S	C min.	CS nom.	Designations	
								With slide ring made of X-ECOPUR 741	
in.									
1	-0.002	1.298	+0.003	0.126	0.149	0.14	0.103	S9B1-1000	S9B1-1000-AD1
	-0.003	1.424	+0.004	0.166	0.212	0.18	0.139	S9B2-1000	S9B2-1000-AD1
1.125	-0.002	1.423	+0.003	0.126	0.149	0.14	0.103	S9B1-1125	S9B1-1125-AD1
1.25	-0.002	1.548	+0.003	0.126	0.149	0.14	0.103	S9B1-1250	S9B1-1250-AD1
	-0.003	1.674	+0.004	0.166	0.212	0.18	0.139	S9B2-1250	S9B2-1250-AD1
1.375	-0.003	1.799	+0.004	0.166	0.212	0.18	0.139	S9B2-1375	S9B2-1375-AD1
1.5	-0.002	1.798	+0.003	0.126	0.149	0.14	0.103	S9B1-1500	S9B1-1500-AD1
	-0.003	1.924	+0.004	0.166	0.212	0.18	0.139	S9B2-1500	S9B2-1500-AD1
	-0.004	2.116	+0.005	0.247	0.308	0.2	0.21	S9B3-1500	S9B3-1500-AD1
1.75	-0.002	2.048	+0.003	0.126	0.149	0.14	0.103	S9B1-1750	S9B1-1750-AD1
	-0.003	2.174	+0.004	0.166	0.212	0.18	0.139	S9B2-1750	S9B2-1750-AD1
	-0.004	2.366	+0.005	0.247	0.308	0.2	0.21	S9B3-1750	S9B3-1750-AD1
1.875	-0.003	2.299	+0.004	0.166	0.212	0.18	0.139	S9B2-1875	S9B2-1875-AD1
	-0.004	2.424	+0.005	0.166	0.212	0.18	0.139	S9B2-2000	S9B2-2000-AD1
2	-0.003	2.616	+0.005	0.247	0.308	0.2	0.21	S9B3-2000	S9B3-2000-AD1
	-0.004	2.674	+0.004	0.166	0.212	0.18	0.139	S9B2-2250	S9B2-2250-AD1
2.25	-0.003	2.866	+0.005	0.247	0.308	0.2	0.21	S9B3-2250	S9B3-2250-AD1
	-0.004	2.924	+0.004	0.166	0.212	0.18	0.139	S9B2-2500	S9B2-2500-AD1
2.5	-0.003	3.116	+0.005	0.247	0.308	0.2	0.21	S9B3-2500	S9B3-2500-AD1
	-0.004	3.241	+0.005	0.247	0.308	0.2	0.21	S9B3-2625	S9B3-2625-AD1
2.625	-0.003	3.049	+0.004	0.166	0.212	0.18	0.139	S9B2-2750	S9B2-2750-AD1
	-0.004	3.241	+0.005	0.247	0.308	0.2	0.21	S9B3-2750	S9B3-2750-AD1

Dimensions								Designations With slide ring made of X-ECOPUR 741	
d	Tolerance	D	Tolerance	L +0.01	S	C min.	CS nom.		
in.								-	
3	-0.003	3.424	+0.004	0.166	0.212	0.18	0.139	S9B2-3000	S9B2-3000-AD1
	-0.004	3.616	+0.005	0.247	0.308	0.2	0.21	S9B3-3000	S9B3-3000-AD1
3.25	-0.004	3.866	+0.005	0.247	0.308	0.2	0.21	S9B3-3250	S9B3-3250-AD1
3.5	-0.004	4.116	+0.005	0.247	0.308	0.2	0.21	S9B3-3500	S9B3-3500-AD1
3.75	-0.004	4.366	+0.005	0.247	0.308	0.2	0.21	S9B3-3750	S9B3-3750-AD1
4	-0.003	4.424	+0.004	0.166	0.212	0.18	0.139	S9B2-4000	S9B2-4000-AD1
	-0.004	4.616	+0.005	0.247	0.308	0.2	0.21	S9B3-4000	S9B3-4000-AD1
	-0.005	4.83	+0.006	0.32	0.415	0.25	0.275	S9B4-4000	S9B4-4000-AD1
4.25	-0.004	4.866	+0.005	0.247	0.308	0.2	0.21	S9B3-4250	S9B3-4250-AD1
	-0.005	5.08	+0.006	0.32	0.415	0.25	0.275	S9B4-4250	S9B4-4250-AD1
4.5	-0.004	5.116	+0.005	0.247	0.308	0.2	0.21	S9B3-4500	S9B3-4500-AD1
	-0.005	5.33	+0.006	0.32	0.415	0.25	0.275	S9B4-4500	S9B4-4500-AD1
4.75	-0.004	5.366	+0.005	0.247	0.308	0.2	0.21	S9B3-4750	S9B3-4750-AD1
	-0.005	5.58	+0.006	0.32	0.415	0.25	0.275	S9B4-4750	S9B4-4750-AD1
5	-0.004	5.616	+0.005	0.247	0.308	0.2	0.21	S9B3-5000	S9B3-5000-AD1
	-0.005	5.83	+0.006	0.32	0.415	0.25	0.275	S9B4-5000	S9B4-5000-AD1
5.25	-0.004	5.866	+0.005	0.247	0.308	0.2	0.21	S9B3-5250	S9B3-5250-AD1
	-0.005	6.08	+0.006	0.32	0.415	0.25	0.275	S9B4-5250	S9B4-5250-AD1
5.5	-0.004	6.116	+0.005	0.247	0.308	0.2	0.21	S9B3-5500	S9B3-5500-AD1
	-0.005	6.33	+0.006	0.32	0.415	0.25	0.275	S9B4-5500	S9B4-5500-AD1
5.75	-0.004	6.366	+0.005	0.247	0.308	0.2	0.21	S9B3-5750	S9B3-5750-AD1
	-0.005	6.58	+0.006	0.32	0.415	0.25	0.275	S9B4-5750	S9B4-5750-AD1
6	-0.004	6.616	+0.005	0.247	0.308	0.2	0.21	S9B3-6000	S9B3-6000-AD1
	-0.005	6.83	+0.006	0.32	0.415	0.25	0.275	S9B4-6000	S9B4-6000-AD1
6.25	-0.004	6.866	+0.005	0.247	0.308	0.2	0.21	S9B3-6250	S9B3-6250-AD1
	-0.005	7.08	+0.006	0.32	0.415	0.25	0.275	S9B4-6250	S9B4-6250-AD1
6.5	-0.004	7.116	+0.005	0.247	0.308	0.2	0.21	S9B3-6500	S9B3-6500-AD1
	-0.005	7.33	+0.006	0.32	0.415	0.25	0.275	S9B4-6500	S9B4-6500-AD1
6.75	-0.004	7.366	+0.005	0.247	0.308	0.2	0.21	S9B3-6750	S9B3-6750-AD1
	-0.005	7.58	+0.006	0.32	0.415	0.25	0.275	S9B4-6750	S9B4-6750-AD1
7	-0.004	7.616	+0.005	0.247	0.308	0.2	0.21	S9B3-7000	S9B3-7000-AD1
	-0.005	7.83	+0.006	0.32	0.415	0.25	0.275	S9B4-7000	S9B4-7000-AD1
7.25	-0.004	7.866	+0.005	0.247	0.308	0.2	0.21	S9B3-7250	S9B3-7250-AD1
	-0.005	8.08	+0.006	0.32	0.415	0.25	0.275	S9B4-7250	S9B4-7250-AD1
7.5	-0.004	8.116	+0.005	0.247	0.308	0.2	0.21	S9B3-7500	S9B3-7500-AD1
	-0.005	8.33	+0.006	0.32	0.415	0.25	0.275	S9B4-7500	S9B4-7500-AD1
7.75	-0.004	8.366	+0.005	0.247	0.308	0.2	0.21	S9B3-7750	S9B3-7750-AD1
	-0.005	8.58	+0.006	0.32	0.415	0.25	0.275	S9B4-7750	S9B4-7750-AD1
8	-0.004	8.616	+0.005	0.247	0.308	0.2	0.21	S9B3-8000	S9B3-8000-AD1
	-0.005	8.83	+0.006	0.32	0.415	0.25	0.275	S9B4-8000	S9B4-8000-AD1
8.5	-0.005	9.33	+0.006	0.32	0.415	0.25	0.275	S9B4-8500	S9B4-8500-AD1
9	-0.005	9.83	+0.006	0.32	0.415	0.25	0.275	S9B4-9000	S9B4-9000-AD1
9.5	-0.005	10.33	+0.006	0.32	0.415	0.25	0.275	S9B4-9500	S9B4-9500-AD1
10	-0.005	10.83	+0.006	0.32	0.415	0.25	0.275	S9B4-10000	S9B4-10000-AD1

Other sizes are available on request



RSB profile data



Material codes	Slide ring: 741 Energizer: A-8501 For additional information → page 26
Pressure	Up to 400 bar (5 800 psi)
Speed	Up to 1 m/s (3.2 ft/s)
Temperature range	<div style="display: flex; align-items: center;"> <div style="margin-left: 10px;"> <p>-40 -30 -20 110 120 [°C]</p> <p>-40 -20 -5 230 250 [°F]</p> </div> </div> <ul style="list-style-type: none"> Extreme low temperature range: may be intermittently exposed (e.g. cold start-up) without seal damage, but seal performance may be compromised while in this range Temperatures below the recommended operating range: seal performance depends on system design (precision guiding arrangement recommended) Recommended operating temperature range for this profile and material Extreme high temperature range: only occasional short-term exposure (e.g. cylinder in curing oven of a powder coating process)
Counter-surface	→ page 22

Maximum values of application parameters (e.g. pressure, speed, temperature, e-gap) should not be applied continuously nor simultaneously.

3.10 RSB profile buffer seals, inch sizes d 1.25 – 6 in.

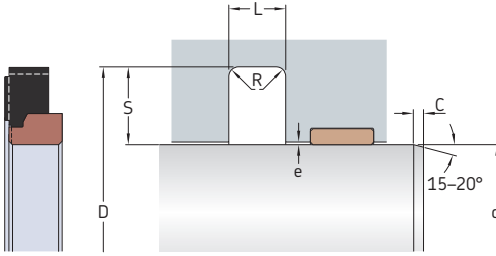

Maximum extrusion gap e

Radial Series e_{max} at 80 °C (175 °F)
depth S for pressures
2 300 psi 3 600 psi 5 800 psi

in.	-	in.			
0.166 to 0.212	RSB2	0.014	0.01	0.008	
0.247 to 0.308	RSB3	0.018	0.012	0.008	
0.32 to 0.415	RSB4	0.02	0.014	0.01	

For additional information → page 34

Dimensions

Designation

d	Tolerance	D	Tolerance	L +0.01	S	R max.	C min.	Designation
in.								-
1.25	-0.003	1.674	+0.004	0.166	0.212	0.022	0.25	RSB2-1250-AD2
1.5	-0.003	1.924	+0.004	0.166	0.212	0.022	0.25	RSB2-1500-AD2
	-0.004	2.116	+0.005	0.247	0.308	0.028	0.312	RSB3-1500-AD2
1.75	-0.003	2.174	+0.004	0.166	0.212	0.022	0.25	RSB2-1750-AD2
2	-0.004	2.616	+0.005	0.247	0.308	0.028	0.312	RSB3-2000-AD2
2.25	-0.003	2.674	+0.004	0.166	0.212	0.022	0.25	RSB2-2250-AD2
	-0.004	2.866	+0.005	0.247	0.308	0.028	0.312	RSB3-2250-AD2
2.375	-0.004	2.991	+0.005	0.247	0.308	0.028	0.312	RSB3-2375-AD2
2.5	-0.003	2.924	+0.004	0.166	0.212	0.022	0.25	RSB2-2500-AD2
	-0.004	3.116	+0.005	0.247	0.308	0.028	0.312	RSB3-2500-AD2
2.75	-0.004	3.366	+0.005	0.247	0.308	0.028	0.312	RSB3-2750-AD2
3	-0.004	3.616	+0.005	0.247	0.308	0.028	0.312	RSB3-3000-AD2
3.25	-0.004	3.866	+0.005	0.247	0.308	0.028	0.312	RSB3-3250-AD2
3.5	-0.004	4.116	+0.005	0.247	0.308	0.028	0.312	RSB3-3500-AD2
3.75	-0.004	4.366	+0.005	0.247	0.308	0.028	0.312	RSB3-3750-AD2
4	-0.004	4.616	+0.005	0.247	0.308	0.028	0.312	RSB3-4000-AD2
4.5	-0.004	5.116	+0.005	0.247	0.308	0.028	0.312	RSB3-4500-AD2
	-0.005	5.33	+0.006	0.32	0.415	0.035	0.312	RSB4-4500-AD2
5	-0.004	5.616	+0.005	0.247	0.308	0.028	0.312	RSB3-5000-AD2
	-0.005	5.83	+0.006	0.32	0.415	0.035	0.312	RSB4-5000-AD2
5.25	-0.004	5.866	+0.005	0.247	0.308	0.028	0.312	RSB3-5250-AD2
5.5	-0.004	6.116	+0.005	0.247	0.308	0.028	0.312	RSB3-5500-AD2
6	-0.004	6.616	+0.005	0.247	0.308	0.028	0.312	RSB3-6000-AD2
	-0.005	6.83	+0.006	0.32	0.415	0.035	0.312	RSB4-6000-AD2

3.10 RSB profile buffer seals, inch sizes d 6.5 – 13 in.

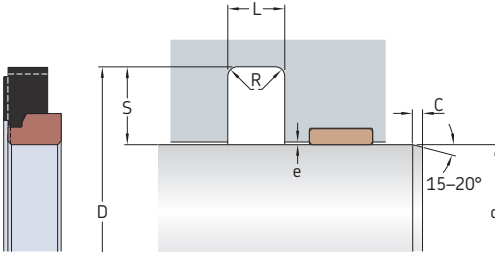

Maximum extrusion gap e

Radial depth S Series e_{\max} at 80 °C (175 °F) for pressures
2 300 psi 3 600 psi 5 800 psi

in.	-	in.			
0.166 to 0.212	RSB2	0.014	0.01	0.008	
0.247 to 0.308	RSB3	0.018	0.012	0.008	
0.32 to 0.415	RSB4	0.02	0.014	0.01	

For additional information → page 34

Dimensions

Designation

d	Tolerance	D	Tolerance	L +0.01	S	R max.	C min.	Designation
in.								-
6.5	-0.005	7.33	+0.006	0.32	0.415	0.035	0.312	RSB4-6500-AD2
7	-0.004	7.616	+0.005	0.247	0.308	0.028	0.312	RSB3-7000-AD2
	-0.005	7.83	+0.006	0.32	0.415	0.035	0.312	RSB4-7000-AD2
8	-0.004	8.616	+0.005	0.247	0.308	0.028	0.312	RSB3-8000-AD2
	-0.005	8.83	+0.006	0.32	0.415	0.035	0.312	RSB4-8000-AD2
8.5	-0.004	9.116	+0.005	0.247	0.308	0.028	0.312	RSB3-8500-AD2
9	-0.005	9.83	+0.006	0.32	0.415	0.035	0.312	RSB4-9000-AD2
10	-0.005	10.83	+0.006	0.32	0.415	0.035	0.312	RSB4-10000-AD2
10.5	-0.004	11.116	+0.005	0.247	0.308	0.028	0.312	RSB3-10500-AD2
11	-0.005	11.83	+0.006	0.32	0.415	0.035	0.312	RSB4-11000-AD2
13	-0.004	13.616	+0.005	0.247	0.308	0.028	0.312	RSB3-13000-AD2
	-0.005	13.83	+0.006	0.32	0.415	0.035	0.312	RSB4-13000-AD2

Other sizes are available on request

Rod and buffer seals

More rod and buffer seals

The rod and buffer seals listed in this catalogue represent the preferred profiles in common sizes. SKF supplies many additional sizes and profiles and provides customized solutions for the toughest application conditions. The following profiles are also manufactured in series production. For additional information about these profiles or if the application requires a solution not provided in this catalogue, contact SKF.

Rod locking T-seals

LTR profiles (→ **fig. 15**) have a T-shaped rubber sealing ring supported by patented locking anti-extrusion rings on both sides. Therefore, they can be used as double-acting rod seals for special applications. For example, in tandem cylinders that require a rod seal to take pressure from both sides. For additional information about materials and sizes, contact SKF.

TEFLATHANE seals

These rod seals of various designs and material combinations incorporate an anti-extrusion ring that is bonded into the body. They are suitable for high temperature and/or short-stroke applications. For example, U-cup seals made of special high-temperature polyurethane bonded to a PTFE anti-extrusion ring in rock hammer applications (→ **fig. 16**). For additional information about materials and sizes, contact SKF.

Chevron V-packing sets

These moulded or machined chevron sets (→ **fig. 17**) are available in a wide variety of materials and designs. They typically consist of a base ring, one or several chevron rings, and a header ring. These rings can be made of different materials to achieve their own specific functional benefits. For additional information about designs, materials and sizes, contact SKF.

Fig. 15

Rod locking T-seal

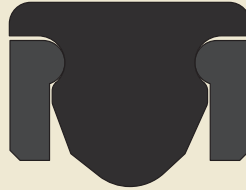

LTR

Fig. 16

TEFLATHANE seal example

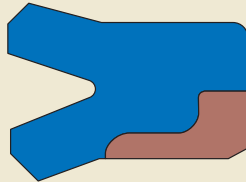
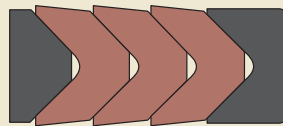

Fig. 17

Chevron set example



SPECTRASEAL

SPECTRASEAL is a PTFE seal that can be used as a single-acting rod seal (→ **fig. 18**). The metal spring energizer adds radial load to the seal lip contact areas. SPECTRASEAL is intended for extreme condition applications including high temperature or aggressive media. For additional information, contact SKF.

Fig. 18

SPECTRASEAL

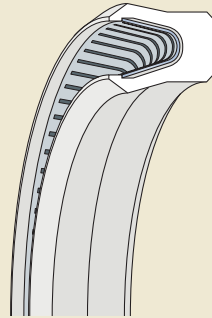

Rod and buffer seals

Customized machined seal profiles

SKF can manufacture a wide variety of rod seal profiles with different materials and sizes with its industry-leading SKF SEAL JET production system (→ **fig. 19**). For additional information about customized machined profiles, refer to publication *Customized machined seals – Product range* or contact SKF.

Fig. 19

SKF SEAL JET profile examples



S01-P



S01-R



S02-P



S02-PD



S02-R



S02-RD



S02-S



S03-P

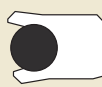

S03-F

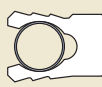

S03-S



S04-P



S04-PD



S05-P



S05-R



S06-P



S06-R



S07-P



S07-F



S08-P



S08-PE



S08-R



S09-E



S09-ES



S09-D



S09-DS



S09-P



S1012-T



S1012-M



S1315-T



S16-A



S16-B



S17-P



S17-R



S18-P



S18-R



S19-F



S20-R



S21-P



S22-P

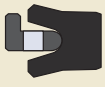

S22-R



S24-P



S2527-F



S2931-F



S32-P



S35-P



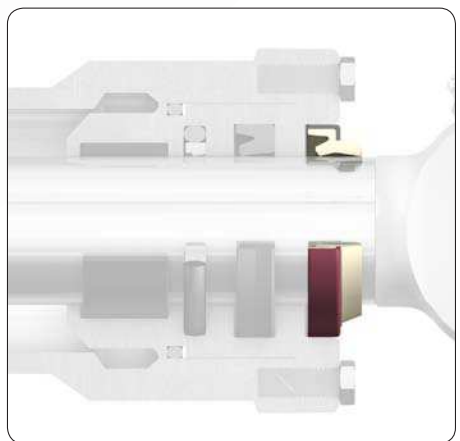
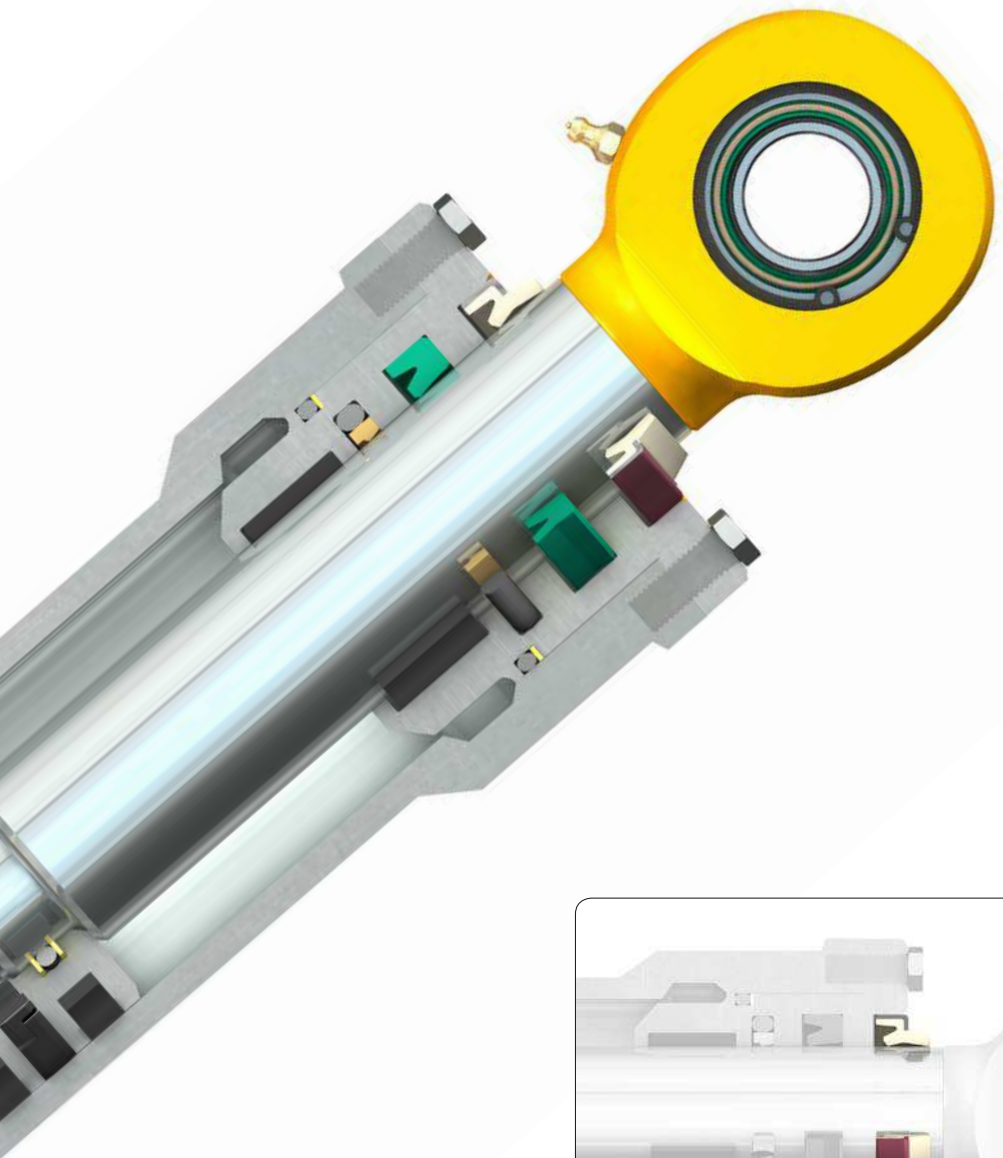



3



Wiper seals

Profile overview	208	Profile data	
Basics	210	4.1 PA	216
Installation	210	Metric sizes	217
Materials	211	4.2 MCW	220
		Metric sizes	221
		Inch sizes	223
Press-in wiper seals	211	4.3 PAD and PADV	226
PA profiles	211	Metric sizes	227
MCW profiles	212	4.4 DTW	228
PAD and PADV profiles	212	Metric sizes	229
		Inch sizes	232
Snap-in wiper seals	213	4.5 DX	236
DTW profiles	214	Inch sizes	237
DX profiles	214	4.6 HW	240
HW profiles	215	Metric sizes	241
		Inch sizes	243
		More wiper seals	246
		PTFE wiper seals	246
		Rod seals used as wiper seals	246
		Customized machined seal profiles	246

Profile overview

Profile	Description	Additional information → page	Profile data → page
PA 	Polyurethane press-in wiper seal; steel retaining ring; single-lip design; lip protrudes from head; small radial cross section	211	216 (metric)
MCW 	Polyurethane press-in wiper seal; steel retaining ring; effective single lip design that sits flush with head; suitable for heavy duty applications	216	220 (metric and inch)
PAD 	Polyurethane press-in wiper seal; steel retaining ring; double-lip design improves rod sealing system performance	212	226 (metric)
PADV 	PAD design with a vent hole in the inside-facing lip	212	226 (metric)
DTW 	Polyurethane snap-in wiper seal; single-lip design; static seal lips on the outside surface and outside face; notches on inside edge of heel	214	228 (metric and inch)
DX 	Polyurethane snap-in wiper seal with nitrile rubber O-ring; single-lip design; patented profile for heavy duty applications; notches on inside edge of heel	214	236 (inch)
HW 	Polyurethane snap-in wiper seal; double-lip design improves rod sealing system performance	215	240 (metric and inch)

Basics

Hydraulic cylinders operate in a variety of applications and environmental conditions, including exposure to dust, debris or outside weather conditions. To prevent these contaminants from entering the cylinder assembly and hydraulic system, wiper seals (also known as scrapers, excluders or dust seals) are fitted on the external side of the cylinder head (→ fig. 1).

Wiper seals maintain sealing contact to the piston rod when the equipment is stationary (static, no reciprocating motion of rod) and in use (dynamic, reciprocating rod), whereas the tolerance for the rod diameter d is determined by the rod seal. Without a wiper seal, the retracting piston rod could transport contaminants into the cylinder.

The outside static sealing of the wiper seal within the housing is also important to avoid moisture or particles from entering around the outside of the wiper seal.

Fig. 1

Wiper seal in typical rod sealing system for medium duty hydraulic applications

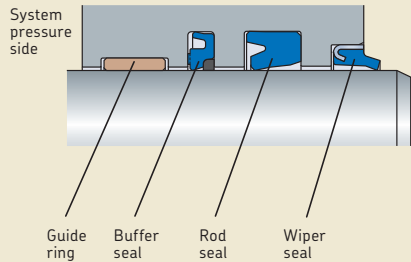

Installation

Housings for wiper seals are typically designed either as open or stepped housings (→ fig. 2).

Wipers for open housings are bonded to a steel retaining ring and pressed into the housing. Therefore, they are called press-in wiper seals.

Wiper seals for stepped housings do not have metal components and can usually be deformed by hand for installation. They “snap” into the groove and, therefore, are called snap-in wiper seal.

For additional information about installation, refer to *Installing wiper seals* (→ page 43).

More information

Counter-surface finish properties	22
Materials	26
Hydraulic fluids	31
Gap extrusion	34
Storage	36
Installation and assembly	38

Fig. 2

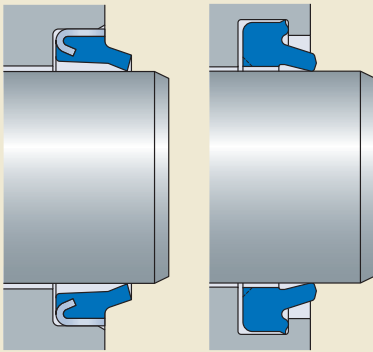
Open housing
(press-in wiper seal)Stepped housing
(snap-in wiper seal)

Materials

Polyurethane (TPU) is the most common material for wiper seals in modern hydraulic seal applications. SKF wiper seals made of TPU are developed for wear resistance and flexibility as well as with the right physical properties to effectively remove contaminants. SKF can supply wiper seals in a wide variety of materials, including rubber elastomers and PTFE (→ *More wiper seals*, page 246).

For additional information, refer to *Materials* (→ page 26).

Press-in wiper seals

As their name implies, press-in wiper seals are pressed into the housing in the cylinder head. These seals are designed with a steel retaining ring that provides a robust static sealing on the outside surface. The polyurethane (TPU) wiper lip is bonded to the drawn sheet steel retaining ring and maintains a sealing force by tension as well as cantilever action (flexing) to the seal lips. This provides a robust preload of the wiper lips even under minor radial misalignments between the rod and head. Press-in wiper seals are available with a single-lip or double-lip design.

PA profiles

PA profiles (→ fig. 3) have an effective single wiping lip that protrudes from the head. This design allows small radial cross sections and reduces the risk of contaminant adherence on the wiper lip. PA profiles are available in metric sizes.

4

Fig. 3

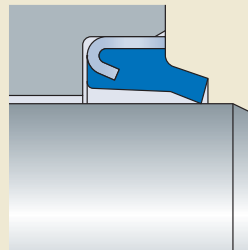

PA

Wiper seals

MCW profiles

MCW profiles (→ **fig. 4**) have an effective single wiping lip that does not protrude from the head. This allows compact arrangement when the cylinder is retracted. These profiles are available in metric and inch sizes.

PAD and PADV profiles

PAD profiles (→ **fig. 5**) have a double-lip design with an internal-facing wiper lip that regulates the lubrication film on the rod. The internal lip wipes excess fluid film from the rod on extending stroke and allows this excess fluid to return under the rod seal on the retracting stroke. Double-acting wipers, therefore, improve the performance and extend the service life of rod sealing systems.

However, excess system pressure acting on the internal-facing lip, such as fluid passing a damaged rod seal, could overcome the press force between the housing and the steel retaining ring and push the wiper seal out of the housing. Therefore, SKF recommends using double-acting wiper seals in combination with U-cup rod seals with a single-lip design, such as S1S profile (→ *Rod seals*, **page 116**), to ensure pressurized fluid can return to the hydraulic system. A snap ring may also be required to retain the wiper seal in the housing (→ **fig. 6**) in case of pressure build up.

PAD profiles (→ **fig. 7**) are also available with a vent in the internal lip (designation PADV). They do not need extra snap rings in most applications. The vent prevents pressure build-up on the internal-facing lip. PAD and PADV profiles are available in the same metric sizes.

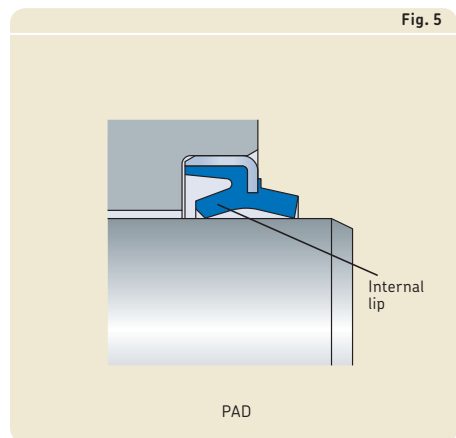
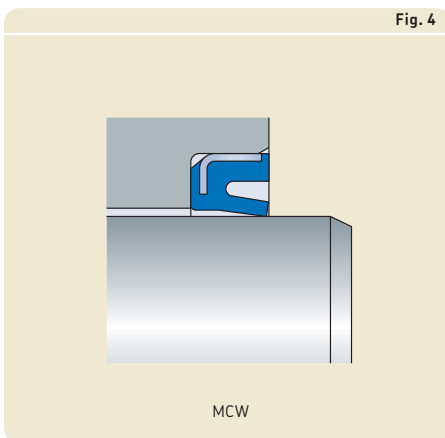
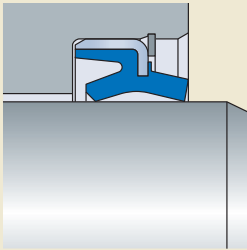
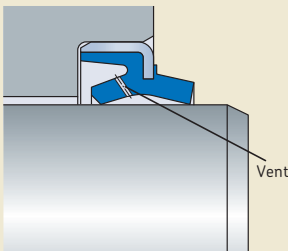

Fig. 6



PAD with snap ring

Fig. 7



PADV

Fig. 8

Snap-in wiper seal loose in the housing

Poor static sealing

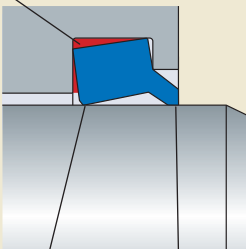

Unintended sealing lip

Reduced preload

Snap-in wiper seals

Snap-in wiper seals are designed without any metal component and are easy to install without any special equipment.

A common problem with snap-in wiper seals is that they become loose in the housing resulting in poor static sealing on the outside surface and reduced preload on the dynamic wiper seal lip (→ **fig. 8**). Furthermore, if the inside edge of the wiper seal could contact the rod, it may become an unintended sealing lip (→ **fig. 8**) and could trap pressure between the rod and wiper seal. Therefore, SKF snap-in wiper seals have special sealing and venting features to help ensure proper operation.

Wiper seals

DTW profiles

DTW profiles (→ **fig. 9**) have a single-lip design and a radial static seal lip on the outside surface that maintains a positive sealing contact. An axial static seal lip on the external side face keeps the wiper tight in the housing and also serves as an additional static seal. During operation the inside edge of the wiper seal could contact the rod, for example during rod extension. In this case and in the event the rod seal has become damaged or exceeded its service life, notches on the inside edge prevent the wiper seal trapping pressure or being pushed out by pressure. These profiles are available in metric and inch sizes.

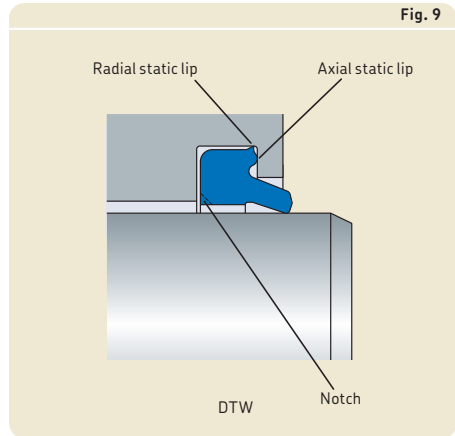

DX profiles

DX wiper seals (→ **fig. 10**) have a patented profile with a single external lip design and vented inside edge. These profiles incorporate a rubber O-ring that maintains a robust static sealing contact in the housing. The O-ring also serves as an energizer to provide consistent long term preload on the dynamic lip. In case of radial misalignment, the entire TPU wiper ring follows these radial movements (“floating” design) as the relatively soft and flexible rubber O-ring energizer deforms to compensate.

When the wiper lip encounters resistance from contaminants adhered to the retracting rod (e.g. tree sap or frozen rain), the profile reacts by twisting to increase the preload on the dynamic wiper lip.

Therefore, DX profiles include the functionality of press-in wiper seals as well as the convenience of snap-in wiper seals. These profiles are available in inch sizes.

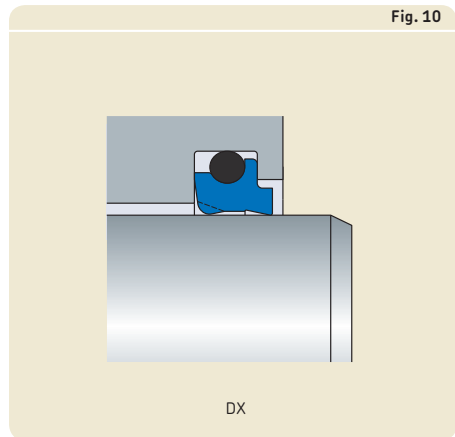

HW profiles

HW profiles (→ **fig. 11**) have a double-lip design with an internal-facing wiper lip that regulates the lubrication film on the rod. The internal lip wipes any excess fluid film from the rod on the extending stroke and allow this excess fluid to return under the rod seal on the retracting stroke. Double-acting wipers, therefore, improve the performance and extend the service life of rod sealing systems. SKF recommends using double-acting wiper seals in combination with U-cup rod seals with a single-lip design, such as S1S profile (→ *Rod seals*, **page 116**), to ensure pressurized fluid can return to the hydraulic system.

Fig. 11

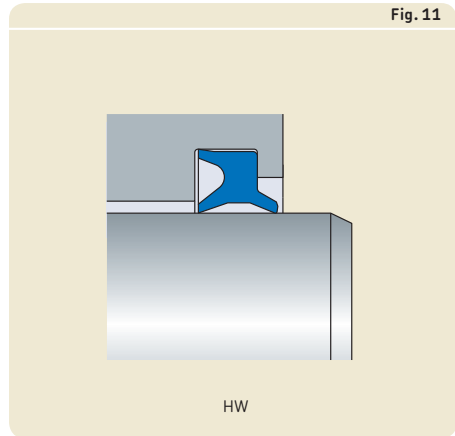

PA profile data



Material code	W93 For additional information → page 26
Speed	Up to 1 m/s (3.2 ft/s)
Temperature range	-40 to +110 °C (-40 to +230 °F)
Dimension standards	Some sizes fit seal housings in accordance with ISO 6195-B.
Counter-surface	→ page 22

Maximum values of application parameters (e.g. speed, temperature) should not be applied continuously nor simultaneously.

4.1 PA profile wiper seals, metric sizes d 12 – 65 mm

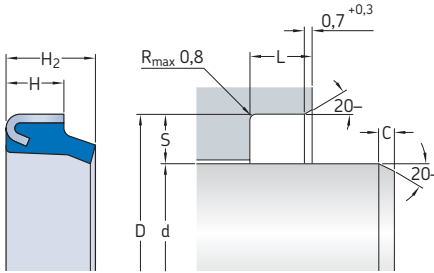

Dimensions							Designation
d ¹⁾	D H8	L +0,5	S	C min.	H	H ₂ +1	
mm							-
12	20	4,5	4	3	4	6	PA 12x20x4x6
20	30	7,5	5	4	7	10	• PA 20x30x7x10
25	35	7,5	5	4	7	10	• PA 25x35x7x10
28	38	7,5	5	4	7	10	• PA 28x38x7x10
30	40	7,5	5	4	7	10	PA 30x40x7x10
32	42	7,5	5	4	7	10	• PA 32x42x7x10
	45	7,5	6,5	5	7	10	PA 32x45x7x10
35	45	7,5	5	4	7	10	PA 35x45x7x10
36	45	7,5	4,5	4	7	10	PA 36x45x7x10
	46	7,5	5	4	7	10	• PA 36x46x7x10
40	50	7,5	5	4	7	10	• PA 40x50x7x10
45	55	7,5	5	4	7	10	• PA 45x55x7x10
	60	7,5	7,5	6	7	10	PA 45x60x7x10
50	60	7,5	5	4	7	10	• PA 50x60x7x10
	65	7,5	7,5	6	7	10	PA 50x65x7x10
55	65	7,5	5	4	7	10	PA 55x65x7x10
	70	7,5	7,5	6	7	10	PA 55x70x7x10
56	66	7,5	5	4	7	10	• PA 56x66x7x10
60	70	7,5	5	4	7	10	PA 60x70x7x10
63	73	7,5	5	4	7	10	• PA 63x73x7x10
	75	7,5	6	4	7	10	PA 63x75x7x10
	78	7,5	7,5	6	7	10	PA 63x78x7x10
65	75	7,5	5	4	7	10	PA 65x75x7x10

• Seal housing dimensions in accordance with ISO 6195-B

¹⁾ Tolerance is determined by the rod seal

4.1 PA profile wiper seals, metric sizes d 70 – 180 mm

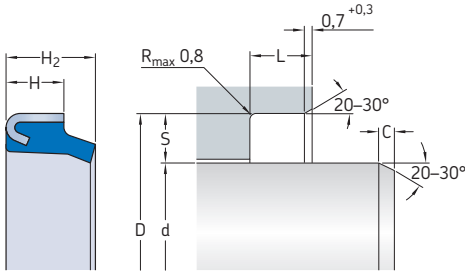

Dimensions							Designation
d ¹⁾	D	L	S	C	H	H ₂	
	H8	+0,5		min.		+1	
mm							-
70	80	7,5	5	4	7	10	• PA 70x80x7x10
75	85	7,5	5	4	7	10	PA 75x85x7x10
80	90	7,5	5	4	7	10	• PA 80x90x7x10
85	95	7,5	5	4	7	10	PA 85x95x7x10
90	100	7,5	5	4	7	10	• PA 90x100x7x10
100	110	7,5	5	4	7	10	PA 100x110x7x10
105	115	7,5	5	4	7	10	PA 105x115x7x10
110	120	7,5	5	4	7	10	PA 110x120x7x10
115	125	7,5	5	4	7	10	PA 115x125x7x10
120	130	7,5	5	4	7	10	PA 120x130x7x10
125	140	9,5	7,5	7	9	12	• PA 125x140x9x12
140	155	9,5	7,5	7	9	12	• PA 140x155x9x12
180	195	9,5	7,5	7	9	12	• PA 180x195x9x12

Other sizes are available on request

• Seal housing dimensions in accordance with ISO 6195-B

¹⁾ Tolerance is determined by the rod seal

MCW profile data



Material codes	Metric sizes → U-1029 Inch sizes → U-1023 For additional information → page 26
Speed	Up to 1,5 m/s (4.9 ft/s)
Temperature range	-40 to +120 °C (-40 to +250 °F)
Dimension standards	Some metric sizes fit seal housings in accordance with ISO 6195-B.
Counter-surface	→ page 22

Maximum values of application parameters (e.g. speed, temperature) should not be applied continuously nor simultaneously.

4.2 MCW profile wiper seals, metric sizes d 20 – 65 mm

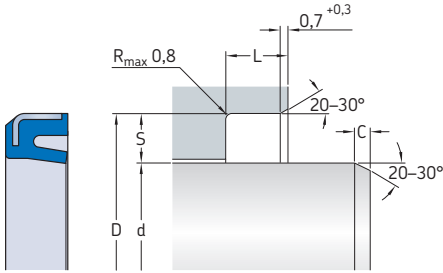

Dimensions					Designation
d ¹⁾	D	L	S	C	
	H8	+0,5		min.	
mm					-
20	30	7	5	5	• MCW-20x30x7-E6Q
25	35	7	5	5	• MCW-25x35x7-E6Q
30	40	7	5	5	• MCW-30x40x7-E6Q
32	42	7	5	5	• MCW-32x42x7-E6Q
35	50	9	7,5	7	MCW-35x50x9-E6Q
36	46	7	5	5	• MCW-36x46x7-E6Q
40	50	7	5	5	• MCW-40x50x7-E6Q
	55	9	7,5	7	MCW-40x55x9-E6Q
45	55	5	5	5	MCW-45x55x5-E6Q
	55	7	5	5	• MCW-45x55x7-E6Q
	60	9	7,5	7	MCW-45x60x9-E6Q
50	60	5	5	5	MCW-50x60x5-E6Q
	60	7	5	5	• MCW-50x60x7-E6Q
	65	9	7,5	7	MCW-50x65x9-E6Q
55	65	5	5	5	MCW-55x65x5-E6Q
56	66	7	5	5	• MCW-56x66x7-E6Q
	68	7	6	5	MCW-56x68x7-E6Q
	71	9	7,5	7	MCW-56x71x9-E6Q
60	70	5	5	5	MCW-60x70x5-E6Q
	74	8	7	7	MCW-60x74x8-E6Q
63	78	9	7,5	7	MCW-63x78x9-E6Q
65	75	5	5	5	MCW-65x75x5-E6Q
	79	8	7	7	MCW-65x79x8-E6Q

• Seal housing dimensions in accordance with ISO 6195-B

¹⁾ Tolerance is determined by the rod seal

4.2 MCW profile wiper seals, metric sizes

d 70 – 130 mm

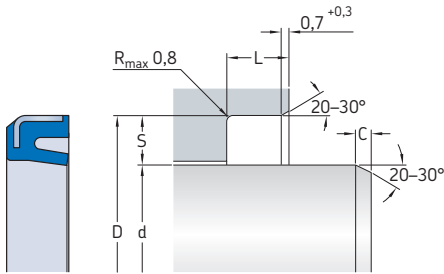

Dimensions					Designation
d ¹⁾	D	L	S	C	
	H8	+0,5		min.	
mm					-
70	80	5	5	5	MCW-70x80x5-E6Q
	80	7	5	5	• MCW-70x80x7-E6Q
	84	8	7	7	MCW-70x84x8-E6Q
	85	7	7,5	7	MCW-70x85x7-E6Q
75	89	8	7	7	MCW-75x89x8-E6Q
	90	7,5	7,5	7	MCW-75x90x7.5-E6Q
80	90	7	5	5	• MCW-80x90x7-E6Q
	94	8	7	7	MCW-80x94x8-E6Q
	100	7	10	7,5	MCW-80x100x7-E6Q
	100	10	10	7,5	MCW-80x100x10-E6Q
85	99	8	7	7	MCW-85x99x8-E6Q
90	104	8	7	7	MCW-90x104x8-E6Q
	105	7	7,5	7	MCW-90x105x7-E6Q
	106	8	8	7	MCW-90x106x8-E6Q
	110	7	10	7,5	MCW-90x110x7-E6Q
95	109	8	7	7	MCW-95x109x8-E6Q
100	110	7	5	5	MCW-100x110x7-E6Q
	114	8	7	7	MCW-100x114x8-E6Q
	116	8	8	7	MCW-100x116x8-E6Q
110	130	8	10	7,5	MCW-110x130x8-E6Q
	130	10	10	7,5	MCW-110x130x10-E6Q
120	136	9	8	7	MCW-120x136x9-E6Q
125	140	9	7,5	7	MCW-125x140x9-E6Q
130	150	10	10	7,5	MCW-130x150x10-E6Q

Other sizes are available on request

• Seal housing dimensions in accordance with ISO 6195-B

¹⁾ Tolerance is determined by the rod seal

4.2 MCW profile wiper seals, inch sizes d 2.25 – 8.5 in.

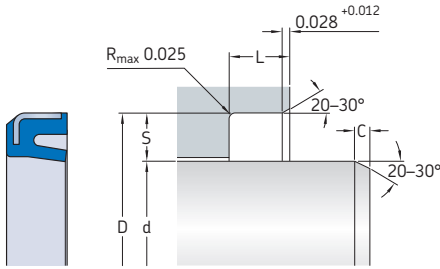

Dimensions					Designation
d ¹⁾	D ±0.001	L +0.015	S	C min.	
in.					–
2.25	2.75	0.312	0.25	0.312	MCW-2250-H9B
	3	0.375	0.25	0.312	MCW375-2250-250-H9B
2.375	2.875	0.312	0.25	0.312	MCW-2375-H9B
2.5	3	0.312	0.25	0.312	MCW-2500-H9B
	3.19	0.345	0.375	0.312	MCW345-2500-375-H9B
2.625	3.125	0.312	0.25	0.312	MCW-2625-H9B
	3.375	0.375	0.375	0.312	MCW375-2625-375-H9B
2.75	3.25	0.312	0.25	0.312	MCW-2750-H9B
	3.5	0.375	0.375	0.312	MCW375-2750-375-H9B
3	3.5	0.312	0.25	0.312	MCW-3000-H9B
	3.75	0.375	0.375	0.312	MCW375-3000-375-H9B
3.125	3.75	0.312	0.312	0.312	MCW-3125-H9B
3.25	3.875	0.312	0.312	0.312	MCW-3250-H9B
3.5	4.125	0.312	0.312	0.312	MCW-3500-H9B
	4.25	0.375	0.312	0.312	MCW375-3500-312-H9B
3.625	4.25	0.312	0.312	0.312	MCW-3625-H9B
3.75	4.375	0.312	0.312	0.312	MCW-3750-H9B
4	4.625	0.312	0.312	0.312	MCW-4000-H9B
4.25	4.875	0.312	0.312	0.312	MCW-4250-H9B
4.5	5.125	0.312	0.312	0.312	MCW-4500-H9B
5	5.625	0.312	0.312	0.312	MCW-5000-H9B

¹⁾ Tolerance is determined by the rod seal

Dimensions					Designation
d ¹⁾	D ±0.001	L +0.015	S	C min.	
in.					-
5.5	6.125	0.375	0.312	0.312	MCW-5500-H9B
	6.25	0.375	0.312	0.312	MCW375-5500-312-H9B
5.75	6.375	0.375	0.312	0.312	MCW-5750-H9B
	6.75	0.5	0.5	0.375	MCW500-5750-500-H9B
6	6.625	0.375	0.312	0.312	MCW-6000-H9B
6.5	7.125	0.312	0.312	0.312	MCW312-6500-312-H9B
6.75	7.375	0.312	0.312	0.312	MCW312-6750-312-H9B
	7.375	0.375	0.312	0.312	MCW-6750-H9B
7	7.75	0.375	0.312	0.312	MCW375-7000-312-H9B
8	8.75	0.375	0.375	0.312	MCW375-8000-375-H9B
8.5	9.125	0.375	0.312	0.312	MCW-8500-H9B

Other sizes are available on request

¹⁾ Tolerance is determined by the rod seal

PAD and PADV profile data

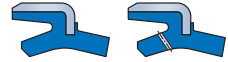

Material code	W93 For additional information → page 26
Speed	Up to 1 m/s (3.2 ft/s)
Temperature range	-40 to +110 °C (-40 to +230 °F)
Counter-surface	→ page 22

Maximum values of application parameters (e.g. speed, temperature) should not be applied continuously nor simultaneously.

4.3 PAD and PADV profile wiper seals, metric sizes d 30 – 120 mm

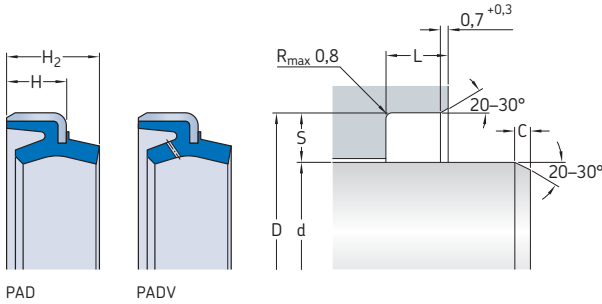

Dimensions							Designations	
d ¹⁾	D	L	S	C	H	H ₂	PAD	PADV (with vent)
	H8	+0,5		min.		+1		
mm							-	
30	42	6,5	6	4	6	9	PAD 30x42x6x9	PADV 30x42x6x9
35	47	7,5	6	4	7	10	PAD 35x47x7x10	PADV 35x47x7x10
40	52	7,5	6	4	7	10	PAD 40x52x7x10	PADV 40x52x7x10
45	57	7,5	6	4	7	10	PAD 45x57x7x10	PADV 45x57x7x10
50	62	7,5	6	4	7	10	PAD 50x62x7x10	PADV 50x62x7x10
55	69	8,5	7	5	8	11	PAD 55x69x8x11	PADV 55x69x8x11
60	74	8,5	7	5	8	11	PAD 60x74x8x11	PADV 60x74x8x11
65	79	8,5	7	5	8	11	PAD 65x79x8x11	PADV 65x79x8x11
70	84	8,5	7	5	8	11	PAD 70x84x8x11	PADV 70x84x8x11
75	89	8,5	7	5	8	11	PAD 75x89x8x11	PADV 75x89x8x11
80	94	8,5	7	5	8	11	PAD 80x94x8x11	PADV 80x94x8x11
85	99	8,5	7	5	8	11	PAD 85x99x8x11	PADV 85x99x8x11
90	104	8,5	7	5	8	11	PAD 90x104x8x11	PADV 90x104x8x11
95	109	8,5	7	5	8	11	PAD 95x109x8x11	PADV 95x109x8x11
100	114	8,5	7	5	8	11	PAD 100x114x8x11	PADV 100x114x8x11
105	121	9,5	8	7	9	12	PAD 105x121x9x12	PADV 105x121x9x12
110	126	9,5	8	7	9	12	PAD 110x126x9x12	PADV 110x126x9x12
115	131	9,5	8	7	9	12	PAD 115x131x9x12	PADV 115x131x9x12
120	136	9,5	8	7	9	12	PAD 120x136x9x12	PADV 120x136x9x12

Other sizes are available on request

¹⁾ Tolerance is determined by the rod seal

4.4 DTW profile

DTW profile data



Material code	U-1003 For additional information → page 26
Speed	Up to 0,75 m/s (2.4 ft/s)
Temperature range	-40 to +120 °C (-40 to +250 °F)
Counter-surface	→ page 22

Maximum values of application parameters (e.g. speed, temperature) should not be applied continuously nor simultaneously.

4.4 DTW profile wiper seals, metric sizes

d 18 – 71 mm

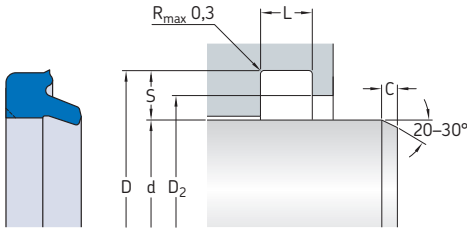

Dimensions						Designation
d ¹⁾	D H11	L +0,2	D ₂ H11	S	C min.	
mm						-
18	26	5	22	4	4,5	DTW-18x26x5-J2G
20	28	5	24	4	4,5	DTW-20x28x5-J2G
25	33	5	29	4	4,5	DTW-25x33x5-J2G
28	36	5	32	4	4,5	DTW-28x36x5-J2G
30	38	6	34	4	4,5	DTW-30x38x6-J2G
32	40	5	36	4	4,5	DTW-32x40x5-J2G
	40	6	36	4	4,5	DTW-32x40x6-J2G
35	43	6	39	4	4,5	DTW-35x43x6-J2G
40	48	5	44	4	4,5	DTW-40x48x5-J2G
	48	6	44	4	4,5	DTW-40x48x6-J2G
45	53	6	49	4	4,5	DTW-45x53x6-J2G
50	58	5	54	4	4,5	DTW-50x58x5-J2G
	58	6	54	4	4,5	DTW-50x58x6-J2G
55	63	6	59	4	4,5	DTW-55x63x6-J2G
	65	7	60	5	5	DTW-55x65x7-J2G
56	64	6	60	4	4,5	DTW-56x64x6-J2G
60	68	6	64	4	4,5	DTW-60x68x6-J2G
	70	7	65	5	5	DTW-60x70x7-J2G
63	71	6	67	4	4,5	DTW-63x71x6-J2G
65	73	6	69	4	4,5	DTW-65x73x6-J2G
	75	7	70	5	5	DTW-65x75x7-J2G
70	80	7	75	5	5	DTW-70x80x7-J2G
71	81	7	76	5	5	DTW-71x81x7-J2G

¹⁾ Tolerance is determined by the rod seal

4.4 DTW profile wiper seals, metric sizes

d 75 – 230 mm

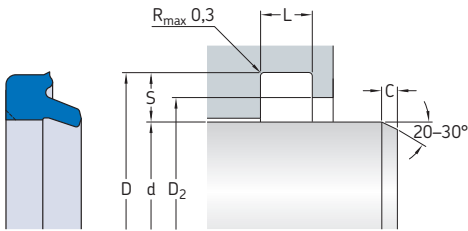

Dimensions						Designation
d ¹⁾	D	L	D ₂	S	C	
	H11	+0,2	H11		min.	
mm						-
75	85	7	80	5	5	DTW-75x85x7-J2G
80	90	7	85	5	5	DTW-80x90x7-J2G
85	95	7	90	5	5	DTW-85x95x7-J2G
90	100	7	95	5	5	DTW-90x100x7-J2G
95	105	7	100	5	5	DTW-95x105x7-J2G
100	110	7	105	5	5	DTW-100x110x7-J2G
105	115	7	110	5	5	DTW-105x115x7-J2G
110	120	7	115	5	5	DTW-110x120x7-J2G
112	122	7	117	5	5	DTW-112x122x7-J2G
115	125	7	120	5	5	DTW-115x125x7-J2G
120	130	7	125	5	5	DTW-120x130x7-J2G
125	138	8	132	6,5	5,5	DTW-125x138x8-J2G
130	143	8	137	6,5	5,5	DTW-130x143x8-J2G
140	153	8	147	6,5	5,5	DTW-140x153x8-J2G
145	158	8	152	6,5	5,5	DTW-145x158x8-J2G
150	163	8	157	6,5	5,5	DTW-150x163x8-J2G
160	173	8	167	6,5	5,5	DTW-160x173x8-J2G
160	174	8	167	7	6	DTW-160x174x8-J2G

¹⁾ Tolerance is determined by the rod seal

Dimensions						Designation
d ¹⁾	D H11	L +0,2	D ₂ H11	S	C min.	
mm						-
170	183	8	177	6,5	5,5	DTW-170x183x8-J2G
170	184	8	177	7	6	DTW-170x184x8-J2G
180	194	8	187	7	6	DTW-180x194x8-J2G
200	213	8	207	6,5	5,5	DTW-200x213x8-J2G
	214	8	207	7	6	DTW-200x214x8-J2G
230	244	8	237	7	6	DTW-230x244x8-J2G

Other sizes are available on request

¹⁾ Tolerance is determined by the rod seal

4.4 DTW profile wiper seals, inch sizes

d 0.25 – 6.5 in.

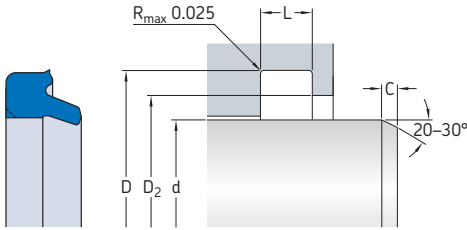

Dimensions					Designation
d ¹⁾	D +0.006	L +0.004	D ₂ +0.005	C min.	
in.					-
0.25	0.497	0.124	0.41	0.125	DTW-250-J2G
0.312	0.56	0.124	0.475	0.125	DTW-312-J2G
0.375	0.622	0.124	0.535	0.125	DTW-375-J2G
0.437	0.685	0.124	0.6	0.125	DTW-437-J2G
0.5	0.747	0.124	0.66	0.125	DTW-500-J2G
0.562	0.81	0.124	0.725	0.125	DTW-562-J2G
0.625	0.872	0.124	0.785	0.125	DTW-625-J2G
0.75	1.122	0.187	0.995	0.187	DTW-750-J2G
0.812	1.185	0.187	1.06	0.187	DTW-812-J2G
0.875	1.247	0.187	1.12	0.187	DTW-875-J2G
0.937	1.31	0.187	1.185	0.187	DTW-937-J2G
1	1.372	0.187	1.245	0.187	DTW-1000-J2G
1.125	1.497	0.187	1.37	0.187	DTW-1125-J2G
1.187	1.559	0.187	1.435	0.187	DTW-1187-J2G
1.25	1.622	0.187	1.495	0.187	DTW-1250-J2G
1.312	1.684	0.187	1.56	0.187	DTW-1312-J2G
1.375	1.747	0.187	1.62	0.187	DTW-1375-J2G
1.5	1.872	0.187	1.745	0.187	DTW-1500-J2G
1.562	1.935	0.187	1.81	0.187	DTW-1562-J2G
1.625	1.997	0.187	1.87	0.187	DTW-1625-J2G

¹⁾ Tolerance is determined by the rod seal

Dimensions					Designation
d ¹⁾	D +0.006	L +0.004	D ₂ +0.005	C min.	
in.					-
1.75	2.122	0.187	1.995	0.187	DTW-1750-J2G
1.875	2.247	0.187	2.12	0.187	DTW-1875-J2G
1.937	2.31	0.187	2.185	0.187	DTW-1937-J2G
2	2.497	0.249	2.327	0.25	DTW-2000-J2G
2.125	2.622	0.249	2.452	0.25	DTW-2125-J2G
2.25	2.747	0.249	2.577	0.25	DTW-2250-J2G
2.375	2.872	0.249	2.702	0.25	DTW-2375-J2G
2.5	2.997	0.249	2.827	0.25	DTW-2500-J2G
2.625	3.122	0.249	2.952	0.25	DTW-2625-J2G
2.75	3.247	0.249	3.077	0.25	DTW-2750-J2G
2.875	3.372	0.249	3.202	0.25	DTW-2875-J2G
3	3.497	0.249	3.327	0.25	DTW-3000-J2G
3.125	3.622	0.249	3.452	0.25	DTW-3125-J2G
3.25	3.747	0.249	3.577	0.25	DTW-3250-J2G
3.375	3.872	0.249	3.702	0.25	DTW-3375-J2G
3.5	3.997	0.249	3.827	0.25	DTW-3500-J2G
3.625	4.122	0.249	3.952	0.25	DTW-3625-J2G
3.75	4.247	0.249	4.077	0.25	DTW-3750-J2G
3.875	4.372	0.249	4.202	0.25	DTW-3875-J2G
4	4.497	0.249	4.327	0.25	DTW-4000-J2G
4.125	4.622	0.249	4.452	0.25	DTW-4125-J2G
4.25	4.747	0.249	4.577	0.25	DTW-4250-J2G
4.375	4.872	0.249	4.702	0.25	DTW-4375-J2G
4.5	5.247	0.374	4.993	0.375	DTW-4500-J2G
4.75	5.497	0.374	5.243	0.375	DTW-4750-J2G
4.875	5.622	0.374	5.368	0.375	DTW-4875-J2G
5	5.747	0.374	5.493	0.375	DTW-5000-J2G
5.25	5.997	0.374	5.743	0.375	DTW-5250-J2G
5.5	6.247	0.374	5.993	0.375	DTW-5500-J2G
5.75	6.497	0.374	6.243	0.375	DTW-5750-J2G
6	6.747	0.374	6.493	0.375	DTW-6000-J2G
6.25	6.997	0.374	6.743	0.375	DTW-6250-J2G
6.5	7.247	0.374	6.993	0.375	DTW-6500-J2G

¹⁾ Tolerance is determined by the rod seal

4.4 DTW profile wiper seals, inch sizes d 6.75 – 15.75 in.

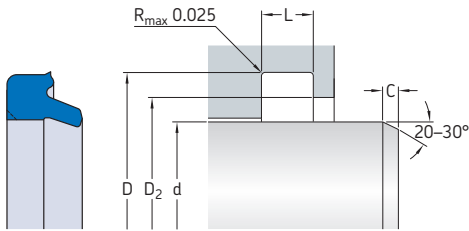

Dimensions					Designation
d ¹⁾	D +0.006	L +0.004	D ₂ +0.005	C min.	
in.					-
6.75	7.497	0.374	7.243	0.375	DTW-6750-J2G
7	7.747	0.374	7.493	0.375	DTW-7000-J2G
7.25	7.997	0.374	7.743	0.375	DTW-7250-J2G
7.5	8.247	0.374	7.993	0.375	DTW-7500-J2G
7.75	8.497	0.374	8.243	0.375	DTW-7750-J2G
8	8.747	0.374	8.493	0.375	DTW-8000-J2G
8.25	8.997	0.374	8.743	0.375	DTW-8250-J2G
8.5	9.247	0.374	8.993	0.375	DTW-8500-J2G
8.75	9.497	0.374	9.243	0.375	DTW-8750-J2G
9	9.747	0.374	9.493	0.375	DTW-9000-J2G
9.5	10.247	0.374	9.993	0.375	DTW-9500-J2G
9.75	10.497	0.374	10.243	0.375	DTW-9750-J2G
10	10.997	0.499	10.659	0.5	DTW-10000-J2G
10.5	11.497	0.499	11.159	0.5	DTW-10500-J2G
11	11.997	0.499	11.659	0.5	DTW-11000-J2G
11.5	12.497	0.499	12.159	0.5	DTW-11500-J2G
12.5	13.497	0.499	13.159	0.5	DTW-12500-J2G
15.75	16.747	0.499	16.409	0.5	DTW-15750-J2G

Other sizes are available on request

¹⁾ Tolerance is determined by the rod seal

DX profile data



Material codes	Seal ring: suffix J1S → U-1003 suffix J2X → U-1004 Energizer: A-8501 For additional information → page 26
Speed	Up to 1 m/s (3.2 ft/s)
Temperature range	-40 to +120 °C (-40 to +250 °F)
Counter-surface	→ page 22

Maximum values of application parameters (e.g. speed, temperature) should not be applied continuously nor simultaneously.

4.5 DX profile wiper seals, inch sizes d 0.75 – 4.25 in.

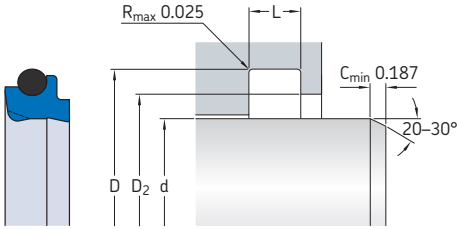

Dimensions				Designation
d ¹⁾	D +0.006	L +0.004	D ₂ +0.005	
in.				-
0.75	1.122	0.187	0.995	DX-750-J1S
1	1.372	0.187	1.245	DX-1000-J1S
1.125	1.497	0.187	1.37	DX-1125-J1S
1.25	1.622	0.187	1.495	DX-1250-J1S
1.375	1.747	0.187	1.62	DX-1375-J1S
1.5	1.872	0.187	1.745	DX-1500-J1S
1.625	1.997	0.187	1.87	DX-1625-J1S
1.75	2.122	0.187	1.995	DX-1750-J1S
2	2.497	0.249	2.327	DX-2000-J1S
2.25	2.747	0.249	2.577	DX-2250-J1S
2.5	2.997	0.249	2.827	DX-2500-J1S
2.75	3.247	0.249	3.077	DX-2750-J1S
3	3.497	0.249	3.327	DX-3000-J1S
3.125	3.622	0.249	3.452	DX-3125-J1S
3.25	3.747	0.249	3.577	DX-3250-J2X
3.375	3.872	0.249	3.702	DX-3375-J2X
3.5	3.997	0.249	3.827	DX-3500-J2X
3.75	4.247	0.249	4.077	DX-3750-J2X
4	4.497	0.249	4.327	DX-4000-J2X
4.25	4.747	0.249	4.577	DX-4250-J2X

¹⁾ Tolerance is determined by the rod seal

4.5 DX profile wiper seals, inch sizes d 4.5 – 9 in.

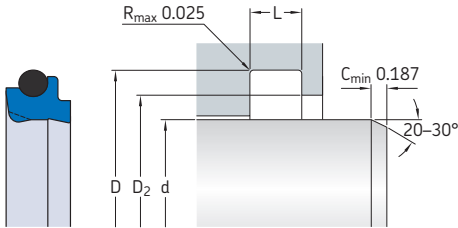

Dimensions				Designation
d ¹⁾	D +0.006	L +0.004	D ₂ +0.005	
in.				-
4.5	5.247	0.374	4.993	DX-4500-J2X
4.625	5.372	0.374	5.118	DX-4625-J2X
4.75	5.497	0.374	5.243	DX-4750-J2X
5	5.747	0.374	5.493	DX-5000-J2X
5.5	6.247	0.374	5.993	DX-5500-J2X
5.75	6.497	0.374	6.243	DX-5750-J2X
6	6.747	0.374	6.493	DX-6000-J2X
6.5	7.247	0.374	6.993	DX-6500-J2X
7	7.747	0.374	7.493	DX-7000-J2X
7.25	7.997	0.374	7.743	DX-7250-J2X
8	8.747	0.374	8.493	DX-8000-J2X
8.5	9.247	0.374	8.993	DX-8500-J2X
9	9.747	0.374	9.493	DX-9000-J2X

Other sizes are available on request

¹⁾ Tolerance is determined by the rod seal

HW profile data



Material code	U-1003 For additional information → page 26
Speed	Up to 0,75 m/s (2.4 ft/s)
Temperature range	-40 to +100 °C (-40 to +210 °F)
Counter-surface	→ page 22

Maximum values of application parameters (e.g. speed, temperature) should not be applied continuously nor simultaneously.

4.6 HW profile wiper seals, metric sizes d 14 – 67 mm

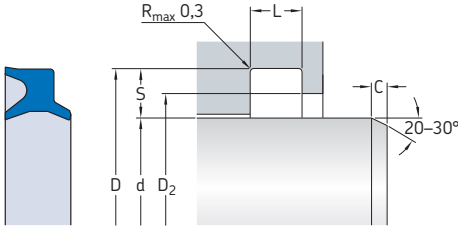

Dimensions						Designation
d ¹⁾	D H11	L +0,2	D ₂ H11	S	C min.	
mm						-
14	22	5	18	4	3,5	HW-14x22x5-J2G
16	24	5	20	4	3,5	HW-16x24x5-J2G
18	26	5	22	4	3,5	HW-18x26x5-J2G
20	28	5	24	4	3,5	HW-20x28x5-J2G
22	30	5	26	4	3,5	HW-22x30x5-J2G
25	33	5	29	4	3,5	HW-25x33x5-J2G
28	36	5	32	4	3,5	HW-28x36x5-J2G
30	38	6	34	4	3,5	HW-30x38x6-J2G
32	40	6	36	4	3,5	HW-32x40x6-J2G
35	43	6	39	4	3,5	HW-35x43x6-J2G
36	44	6	40	4	3,5	HW-36x44x6-J2G
40	48	6	44	4	3,5	HW-40x48x6-J2G
45	53	6	49	4	3,5	HW-45x53x6-J2G
50	58	6	54	4	3,5	HW-50x58x6-J2G
55	63	6	59	4	3,5	HW-55x63x6-J2G
56	64	6	60	4	3,5	HW-56x64x6-J2G
60	68	6	64	4	3,5	HW-60x68x6-J2G
63	71	6	67	4	3,5	HW-63x71x6-J2G
65	73	6	69	4	3,5	HW-65x73x6-J2G
67	75	6	71	4	3,5	HW-67x75x6-J2G

¹⁾ Tolerance is determined by the rod seal

4.6 HW profile wiper seals, metric sizes

d 70 – 140 mm

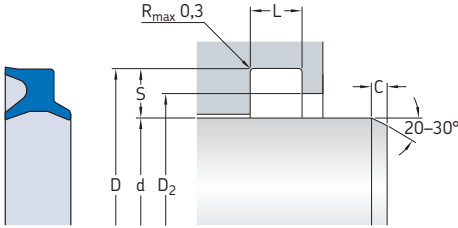

Dimensions						Designation
d ¹⁾	D H11	L +0,2	D ₂ H11	S	C min.	
mm						-
70	80	7	75	5	3,5	HW-70x80x7-J2G
75	85	7	80	5	3,5	HW-75x85x7-J2G
80	90	7	85	5	3,5	HW-80x90x7-J2G
85	95	7	90	5	3,5	HW-85x95x7-J2G
90	100	7	95	5	3,5	HW-90x100x7-J2G
95	105	7	100	5	3,5	HW-95x105x7-J2G
98	108	7	103	5	3,5	HW-98x108x7-J2G
100	110	7	105	5	3,5	HW-100x110x7-J2G
105	115	7	110	5	3,5	HW-105x115x7-J2G
112	122	7	117	5	3,5	HW-112x122x7-J2G
125	138	8	132	6,5	4,5	HW-125x138x8-J2G
140	153	8	147	6,5	4,5	HW-140x153x8-J2G

Other sizes are available on request

¹⁾ Tolerance is determined by the rod seal

4.6 HW profile wiper seals, inch sizes d 0.25 – 3.25 in.

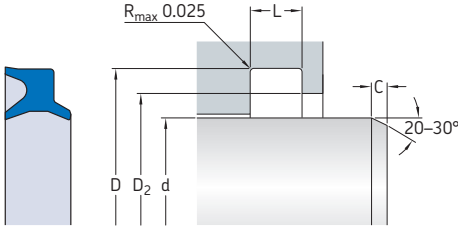

Dimensions					Designation
d ¹⁾	D	L	D ₂	C	
	+0.003	+0.015	+0.003	min.	
in.					-
0.25	0.552	0.203	0.37	0.187	HW-250-J2G
0.5	0.802	0.203	0.62	0.187	HW-500-J2G
0.625	0.927	0.203	0.745	0.187	HW-625-J2G
0.75	1.052	0.203	0.87	0.187	HW-750-J2G
0.937	1.302	0.218	1.072	0.187	HW-937-J2G
1	1.365	0.218	1.135	0.187	HW-1000-J2G
1.25	1.615	0.218	1.385	0.187	HW-1250-J2G
1.375	1.74	0.218	1.51	0.187	HW-1375-J2G
1.437	1.802	0.218	1.572	0.187	HW-1437-J2G
1.5	1.865	0.218	1.635	0.187	HW-1500-J2G
1.625	1.99	0.218	1.76	0.187	HW-1625-J2G
1.75	2.115	0.218	1.885	0.187	HW-1750-J2G
1.875	2.24	0.218	2.01	0.187	HW-1875-J2G
2	2.365	0.218	2.135	0.187	HW-2000-J2G
2.125	2.49	0.218	2.26	0.187	HW-2125-J2G
2.25	2.745	0.281	2.385	0.25	HW-2250-J2G
2.5	2.995	0.281	2.635	0.25	HW-2500-J2G
2.625	3.12	0.281	2.76	0.25	HW-2625-J2G
3	3.495	0.281	3.135	0.25	HW-3000-J2G
3.25	3.745	0.281	3.385	0.25	HW-3250-J2G

¹⁾ Tolerance is determined by the rod seal

4.6 HW profile wiper seals, inch sizes d 3.5 – 8 in.

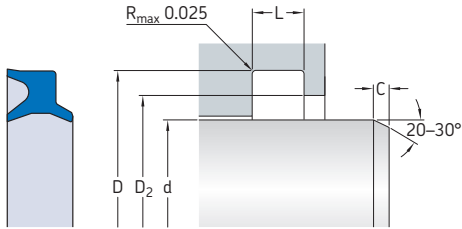

Dimensions					Designation
d ¹⁾	D +0.003	L +0.015	D ₂ +0.003	C min.	
in.					-
3.5	3.995	0.281	3.635	0.25	HW-3500-J2G
3.75	4.245	0.281	3.885	0.25	HW-3750-J2G
4	4.495	0.281	4.135	0.25	HW-4000-J2G
4.25	4.745	0.281	4.385	0.25	HW-4250-J2G
4.5	4.995	0.281	4.635	0.25	HW-4500-J2G
4.75	5.245	0.281	4.885	0.25	HW-4750-J2G
5	5.495	0.281	5.135	0.25	HW-5000-J2G
5.125	5.62	0.281	5.26	0.25	HW-5125-J2G
5.25	5.745	0.281	5.385	0.25	HW-5250-J2G
7	7.495	0.281	7.135	0.25	HW-7000-J2G
8	8.495	0.281	8.135	0.25	HW-8000-J2G

Other sizes are available on request

¹⁾ Tolerance is determined by the rod seal

Wiper seals

More wiper seals

PTFE wiper seals

SKF wiper seals made of PTFE (→ **fig. 12**) are intended for applications where there is a demand for low breakaway friction or good chemical resistance. SKF has material for PTFE wiper seals on stock and, therefore, can supply these seals in a wide variety of profiles and different sizes at short notice.

For additional information about PTFE wiper seals, contact SKF.

Rod seals used as wiper seals

STD rod seal profiles (→ *STD profiles*, **page 118**) can also be used as snap-in wiper seals (→ **fig. 13**).

For additional information about rod seals used as wiper seals, contact SKF.

Customized machined seal profiles

SKF can manufacture a wide variety of wiper seal profiles (→ **fig. 14**) with different materials and customized sizes with its industry-leading SKF SEAL JET production system. SKF can supply these customized machined wiper seals in close partnership with customers from the design phase to serial production.

For additional information about customized machined profiles, refer to publication *Customized machined seals – Product range* or contact SKF.

Fig. 12

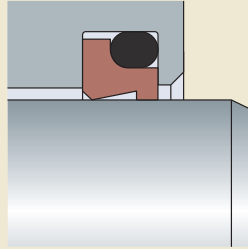

Fig. 13

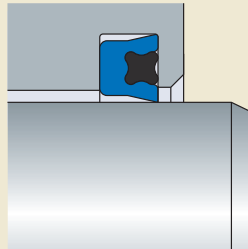

Fig. 14

SKF SEAL JET profile examples



A01-A



A01-B



A02-A



A02-B



A02-I



A03-A



A04-A



A04-B



A05-A



A05-B



A05-I



A06-A



A07-A



A08-A



A08-B



A09-A



A10-A



A11-A



A11-I



A12-A



A12-B



A13-A

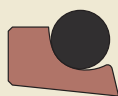

A25-F



A26-F



A27-F

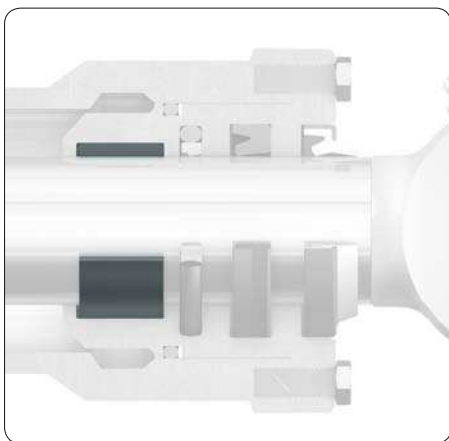
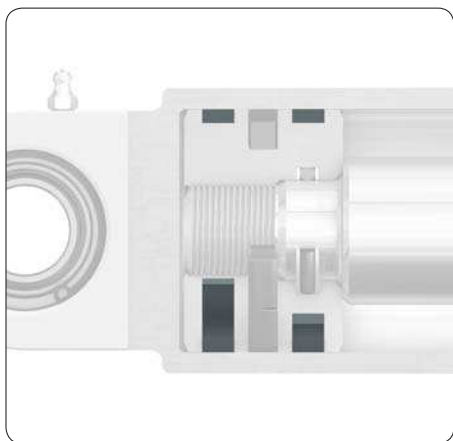
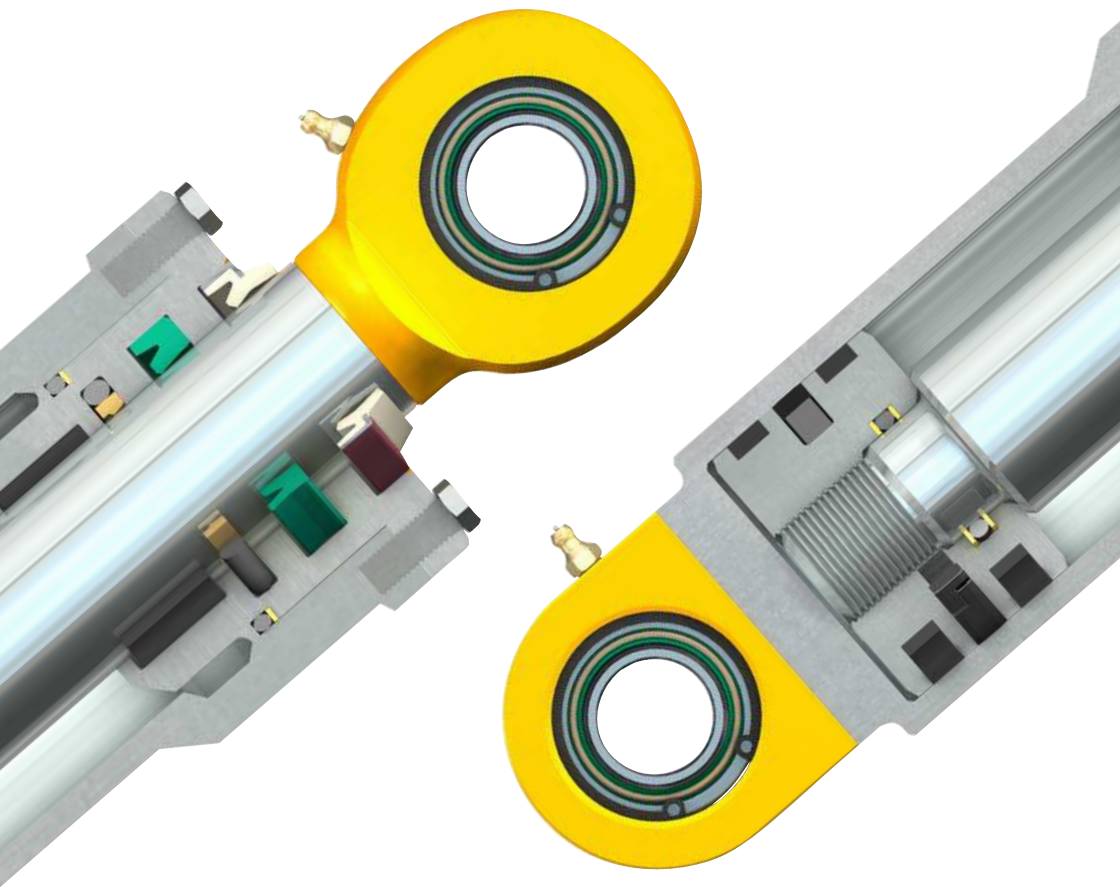

Guide rings and guide strips

Basics	250	Profile data	
Guide lubrication	250	5.1 WAT rod or piston guide rings, metric sizes	256
Materials	251	5.2 WAT rod or piston guide rings, inch sizes	262
Guide rings	253	5.3 RGR rod guide rings, metric sizes	276
WAT rod or piston guide rings	253	5.4 PGR piston guide rings, metric sizes	280
RGR rod guide rings	253		
PGR piston guide rings	253	Guide strips	284
Design and calculation model	254	More guides	288
Concentric alignment of cylinder components	254	Spark rings	288
Guide distance	254	Customized machined guide profiles	288
Load distribution model	254		
Calculation considerations	255		
Calculating the guide width	255		

Basics

In hydraulic cylinders the most commonly used guides are guide rings and guide strips. They accommodate radial loads of forces acting on the cylinder assembly and guide the rod in the cylinder head as well as the piston in the cylinder bore (→ **fig. 1**).

Guides are made of polymer materials and prevent metal-to-metal contact between moving parts in a working hydraulic cylinder. Compared to metal guides, polymer guides provide the following advantages in hydraulic cylinders:

- significantly longer service life
- work more smoothly against the cylinder bore and the sealing surfaces
- avoid wear of cylinder surfaces despite the presence of contamination particles

More information

Counter-surface finish properties	22
Materials	26
Hydraulic fluids	31
Storage	36

- high resistance to insufficient lubrication at low speeds
- larger contact area (→ **fig. 2, page 251** and **fig. 4, page 254**) due to higher degree of elastic deformation distributes the load and reduces stress to counter-surface
- certain self-lubricating properties

SKF supplies different precision machined guide rings with different polymer materials and sizes, which make them appropriate for a wide variety of operating conditions and applications.

Guides of PTFE are also available for applications where start-up friction must be minimized. PTFE guides have limited load carrying capability and should only be used in applications with light loads.

Guide lubrication

The guide must receive ample lubrication at all times. Rod guides are typically placed inward of both the rod and buffer seal and should be lubricated on assembly with the same medium as used in the system. SKF recommends to place guides not outside of the rod seal, means between the wiper and rod seal. However, in certain conditions, PTFE guides may be used outside the rod seal due to their certain self-lubricating properties.

Fig. 1

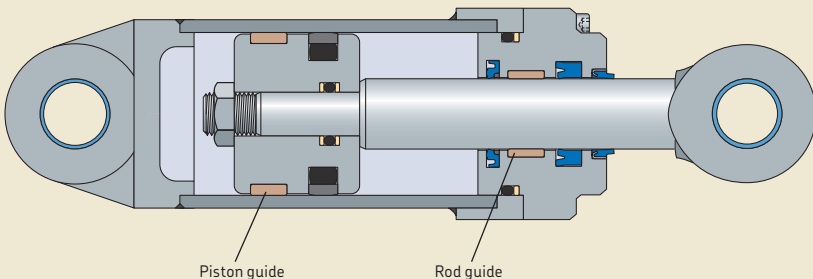
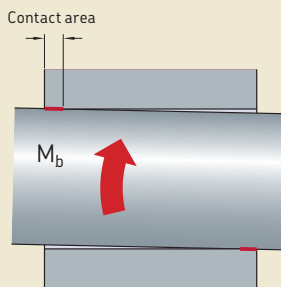
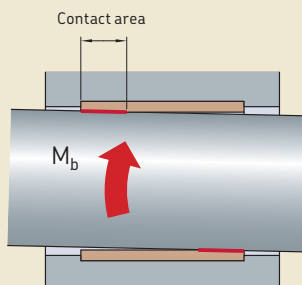

Fig. 2



Metal guide



Polymer guide

Materials

The demands on reliability are continuously increasing. At the same time, the service conditions are getting tougher to match the development towards higher effectiveness of the hydraulic systems. Therefore, it is very important to be familiar with the operating conditions and parameters, such as operating temperature and pressure, load, speed, and fluid when choosing the most appropriate guide material. The most common materials for guides listed in this catalogue are:

- glass fibre reinforced polyamide
- fabric reinforced phenolic resin
- PTFE

Polyamide

Glass fibre reinforced polyamide guides are suitable for medium and heavy duty applications and are characterized by the following properties:

- wide temperature range
- wear resistant
- reduce vibrations
- protect seals from particles
- protect components from diesel effect
- easy to install
- tight tolerances
- withstand heavy side loads
- withstand high cycling speed
- prone to moisture swell before installation

P-2551 is the standard polyamide material for guide rings. Technical specifications are provided in **table 1** (→ **page 252**).

For additional information, refer to *Materials* (→ **page 26**).

Fabric reinforced composites

Fabric reinforced composites consist of cotton fabric bound with thermoset phenolic resin. Its structure and the ability of the fabric fibres to absorb a certain amount of oil make these phenolic guides almost self-lubricating. However, cotton reinforced phenolic guide rings should not be used at high stroke speeds over 0,5 m/s (1.6 ft/s). They are suitable for medium and heavy duty applications and are characterized by the following properties:

Guide rings and guide strips

- wide temperature range
- wear resistant
- reduce vibrations
- protect seals from particles
- protect components from diesel effect
- low thermal expansion
- easy to install
- tight tolerances
- withstand heavy side loads

Phenolic resin with cotton fabric laminate (PF) is the standard fabric reinforced composite. Technical specifications are provided in **table 1**. SKF also supplies a variety of other thermoset resins and fabrics on request.

For additional information, refer to *Materials* (→ **page 26**).

PTFE

PTFE is typically used in guides where low friction and resistance to chemicals, heat or wear are essential. However, PTFE should only be used in applications with low surface pressure. To obtain optimal wear resistance, PTFE materials are available with different fillers, such as bronze or carbon powder. PTFE guides are characterized by the following properties:

- chemical resistance
- wide temperature range
- low friction
- anti-adhesive, low breakaway friction
- good wear resistance
- reduce vibrations
- protect seals from particles
- protect components from diesel effect
- tight tolerance machined guide rings available

292 is the standard PTFE material for guides and strips. Technical specifications are provided in **table 1**. SKF also can supply many other PTFE material compounds on request.

For additional information, refer to *Materials* (→ **page 26**).

Table 1

Guide ring material comparison					
Material code	Ultimate compressive strength	Maximum recommended linear speed ¹⁾	Maximum recommended operating temperature ¹⁾	Maximum recommended bearing load pressure ¹⁾ at 20 °C (70 °F)	Maximum recommended bearing load pressure ¹⁾ at 80 °C (175 °F)
–	N/mm ² (psi)	m/s (ft/s)	°C (°F)	N/mm ² (psi)	N/mm ² (psi)
P-2551	158 (22 915)	1 (3.3)	120 (250)	40 (5 800)	30 (4 350)
PF	240 (34 805)	0,5 (1.6)	120 (250)	50 (7 250)	30 (4 350)
292	²⁾ (depending on time and temperature)	5 (16.4) (depending on sealing system)	200 (390)	15 (2 175)	7,5 (1 085)

¹⁾ Maximum values are for intermittent exposure and should not be applied simultaneously.
²⁾ PTFE is subject to creep under compression and, therefore, compressive strength depends on time and temperature.

Guide rings

SKF guide rings are precision machined according to tight tolerance specifications on the radial section of the guide. Therefore, they optimize guide load distribution and limit radial misalignment of components for best seal performance. SKF supplies the following guide rings:

- WAT rod or piston guide rings
- RGR rod guide rings
- PGR piston guide rings

All of these precision guide rings are split with an angle cut as standard (→ **fig. 8, page 285**). Other types and designs or angles of cut are available on request.

WAT rod or piston guide rings

These standard guide rings can operate dynamically either on their outside or inside surfaces and, therefore, can be used in piston or rod applications. WAT guide rings are made of glass fibre reinforced polyamide (P-2551) as standard. On request, SKF can supply WAT guide rings in a variety of materials, including P-2552 (self lubricated rings with PTFE fillers).

RGR rod guide rings

RGR guide rings are developed for guiding rods by operating dynamically on their inside surface. They are made of phenolic resin with cotton fabric laminate (PF) as standard. On request, SKF can supply RGR guide rings in a variety of materials.

They are manufactured and packaged to promote an open split before installation and, therefore, are clamped with their outside surface in the cylinder head. This makes it easier to assemble the cylinder later.

PGR piston guide rings

PGR guide rings are developed for guiding pistons by operating dynamically on their outside surface. They are made of phenolic resin with cotton fabric laminate (PF) as standard. On request, SKF can supply PGR guide rings in a variety of materials.

They are manufactured and packaged to promote a narrow split or even closed ring before installation and, therefore, are clamped with their inside surface on the piston. This makes it easier to assemble the cylinder later.

Design and calculation model

Concentric alignment of cylinder components

Hydraulic cylinders and all their components are designed to minimize radial movements at load or pressure changes. It is also important that the piston and rod remain in a concentric position during the entire stroke to maintain seal effectiveness, especially at low temperatures, and to minimize the buckling loads on the piston rod. This in turn depends on the combined tolerances of the cylinder bore, the rod, the radial thickness of the guide rings or strips, and the housing diameters.

Guide distance

The bending moment on the cylinder components and the load on guides at any point in the cylinder stroke are a function of the radial loads and the distance between the rod and piston guides. Therefore, the distance between guides should be considered when designing the cylinder and calculating the guide loads.

Load distribution model

With metal guides, the close machining tolerances would cause narrow contact area and high surface pressure (\rightarrow fig. 3). That could cause damage or wear to the contact surfaces.

The higher degree of elastic deformation of polymer materials provides larger contact surfaces and a better utilization of the guide width (\rightarrow fig. 4). While the guide ring load is realistically not an even distribution, the guide ring load and width requirements are estimated with the projected area of the full dynamic surface (inside diameter for rod guides or outside diameter for piston guides) assuming the load is carried evenly across the surface (\rightarrow fig. 5).

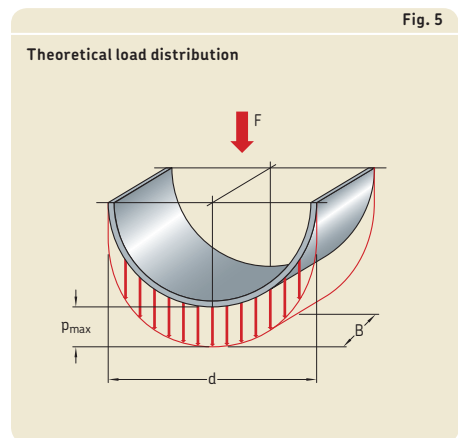
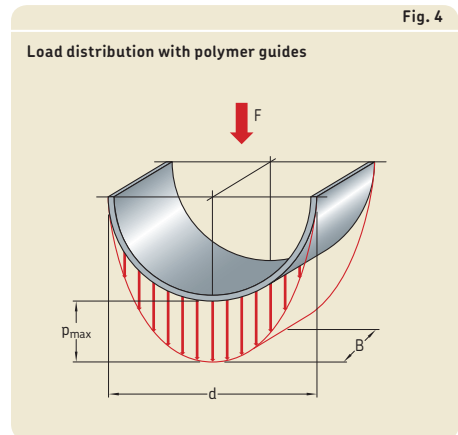
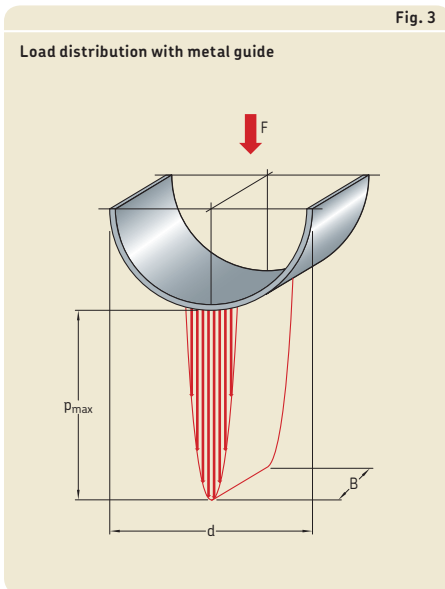

Calculation considerations

When calculating the requisite guide housing width L , the above assumption should be taken into consideration by using a safety factor f . SKF recommends using a safety factor f of at least 2 for operating temperatures up to 80 °C (175 °F). For operating temperatures above 80 °C (175 °F), the safety factor should be increased. However, at temperatures above 120 °C (250 °F), the selection of guide materials is significantly restricted.

The reduced effective load carrying width B of the guide (→ **fig. 5**) also need to be considered. It is approx. 2 mm (0.08 in.) smaller than the housing groove width due to the manufacturing and installation tolerances and the reduction by the chamfers and radii.

Furthermore, dynamic forces, accelerating forces, vibrations and angular forces should be considered when calculating the transverse forces from the rod ends of the cylinders.

For additional information, contact SKF.

Calculating the guide width

The requisite guide width can be calculated for:

- piston guide housing width using

$$L = \frac{F f}{p D} + 2$$

- rod guide housing width using

$$L = \frac{F f}{p d} + 2$$

where

L = requisite guide housing width [mm]

D = cylinder bore diameter [mm]

d = rod diameter [mm]

F = radial load [N]

f = safety factor (→ *Calculation considerations*)

p = maximum recommended bearing load pressure [N/mm²] (→ **table 1, page 252**)

Calculation example

What is the required guide housing width L for a PGR piston guide ring made of phenolic resin with cotton fabric laminate (PF), a cylinder bore diameter of $D = 100$ mm, considering a radial load of 20 000 N and an operating temperature of 80 °C (normal conditions)?

From **table 1** (→ **page 252**), the maximum recommended bearing load pressure $p = 30$ N/mm². The safety factor is chosen with 2. The requisite guide housing width L is

$$L = \frac{20\,000 \times 2}{30 \times 100} + 2 = 15,3 \text{ mm}$$

The requisite guide housing width is 15,3 mm. However, choose a 20 mm housing width, which is the nearest larger housing and guide width L , such as guide ring PGR 100x94x20-PF (→ **product table, page 281**).

5.1 WAT rod or piston guide rings, metric sizes

D 28 – 86 mm

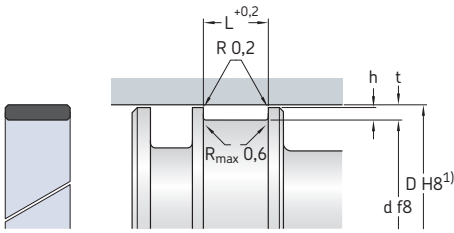

Piston application
(dynamic on the outside surface)

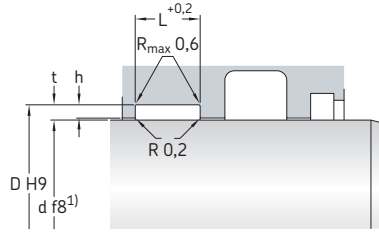

Rod application
(dynamic on the inside surface)

$h \geq t/2$

Dimensions				Designation
D	d	L	t	
mm				
28	25	5,6	1,5	WAT-25x28x5.6-E8D
28,1	25	4	1,55	WAT-25x28.1x4-E8D
30	25	5,6	2,5	WAT-25x30x5.6-E8D
	25	9,7	2,5	WAT-25x30x9.7-E8D
	26	8	2	WAT-26x30x8-E8D
	27	5,6	1,5	WAT-27x30x5.6-E8D
31	27	8	2	WAT-27x31x8-E8D
	28	5,6	1,5	WAT-28x31x5.6-E8D
31,1	28	4	1,55	WAT-28x31.1x4-E8D
32	27	5,6	2,5	WAT-27x32x5.6-E8D
	28	8	2	WAT-28x32x8-E8D
	28,9	4	1,55	WAT-28.9x32x4-E8D
	29	5,6	1,5	WAT-29x32x5.6-E8D
33	28	5,6	2,5	WAT-28x33x5.6-E8D
	29	10	2	WAT-29x33x10-E8D
	30	5,6	1,5	WAT-30x33x5.6-E8D
35	30	15,3	2,5	WAT-30x35x15.3-E8D
	31	8	2	WAT-31x35x8-E8D
	31	10	2	WAT-31x35x10-E8D
	32	5,6	1,5	WAT-32x35x5.6-E8D
36	33	5,6	1,5	WAT-33x36x5.6-E8D
37	32	5,6	2,5	WAT-32x37x5.6-E8D
	32	9,7	2,5	WAT-32x37x9.7-E8D
	32	15	2,5	WAT-32x37x15-E8D
38	34	10	2	WAT-34x38x10-E8D
	35	5,6	1,5	WAT-35x38x5.6-E8D
39	36	5,6	1,5	WAT-36x39x5.6-E8D

Dimensions				Designation
D	d	L	t	
mm				
40	35	5,6	2,5	WAT-35x40x5.6-E8D
	35	10	2,5	WAT-35x40x10-E8D
	35	15	2,5	WAT-35x40x15-E8D
36	8	2		WAT-36x40x8-E8D
	10	2		WAT-36x40x10-E8D
	4	1,55		WAT-36.9x40x4-E8D
	5,6	1,5		WAT-37x40x5.6-E8D
	37	5,6	1,5	WAT-37x40x5.6-E8D
41	36	5,6	2,5	WAT-36x41x5.6-E8D
	36	9,7	2,5	WAT-36x41x9.7-E8D
	37	15	2	WAT-37x41x15-E8D
	37	15,3	2	WAT-37x41x15.3-E8D
38	5,6	1,5	WAT-38x41x5.6-E8D	
42	37	5,6	2,5	WAT-37x42x5.6-E8D
43	38	15	2,5	WAT-38x43x15-E8D
	38	15,3	2,5	WAT-38x43x15.3-E8D
	40	5,6	1,5	WAT-40x43x5.6-E8D
45	40	5,6	2,5	WAT-40x45x5.6-E8D
	40	8	2,5	WAT-40x45x8-E8D
	40	9,7	2,5	WAT-40x45x9.7-E8D
	40	15	2,5	WAT-40x45x15-E8D
	40	20	2,5	WAT-40x45x20-E8D
47	42	5,6	2,5	WAT-42x47x5.6-E8D
	42	15	2,5	WAT-42x47x15-E8D
50	44	10	3	WAT-44x50x10-E8D
	45	5,6	2,5	WAT-45x50x5.6-E8D
	45	8	2,5	WAT-45x50x8-E8D
	45	9,7	2,5	WAT-45x50x9.7-E8D
	45	15	2,5	WAT-45x50x15-E8D
45	15,3	2,5	WAT-45x50x15.3-E8D	
46,9	4	1,55	WAT-46.9x50x4-E8D	

¹⁾ Adjustments according to tolerances provided for rod or piston seals are possible, however, the maximum e-gap also need to be considered (→ Gap extrusion, page 34)

Dimensions				Designation	Dimensions				Designation
D	d	L	t		D	d	L	t	
mm				-	mm				-
55	50	5,6	2,5	WAT-50x55x5,6-E8D	70	62	25	4	WAT-62x70x25-E8D
	50	5,8	2,5	WAT-50x55x5,8-E8D		64	13	3	WAT-64x70x13-E8D
	50	8	2,5	WAT-50x55x8-E8D		65	9,7	2,5	WAT-65x70x9,7-E8D
	50	9,7	2,5	WAT-50x55x9,7-E8D		65	10	2,5	WAT-65x70x10-E8D
	50	15	2,5	WAT-50x55x15-E8D		65	13	2,5	WAT-65x70x13-E8D
	50	15,3	2,5	WAT-50x55x15,3-E8D		65	15	2,5	WAT-65x70x15-E8D
56	51	5,6	2,5	WAT-51x56x5,6-E8D	65	20	2,5	WAT-65x70x20-E8D	
	51	8	2,5	WAT-51x56x8-E8D	65	20,3	2,5	WAT-65x70x20,3-E8D	
	51	15	2,5	WAT-51x56x15-E8D	71	66	10	2,5	WAT-66x71x10-E8D
	51	15,3	2,5	WAT-51x56x15,3-E8D		66	20	2,5	WAT-66x71x20-E8D
60	54	13	3	WAT-54x60x13-E8D	73	68	10	2,5	WAT-68x73x10-E8D
	55	5,6	2,5	WAT-55x60x5,6-E8D		68	13	2,5	WAT-68x73x13-E8D
	55	8	2,5	WAT-55x60x8-E8D	75	69	10	3	WAT-69x75x10-E8D
	55	9,7	2,5	WAT-55x60x9,7-E8D		69	13	3	WAT-69x75x13-E8D
	55	10	2,5	WAT-55x60x10-E8D	70	5,6	2,5	WAT-70x75x5,6-E8D	
	55	13	2,5	WAT-55x60x13-E8D	70	9,7	2,5	WAT-70x75x9,7-E8D	
55	15,3	2,5	WAT-55x60x15,3-E8D	70	10	2,5	WAT-70x75x10-E8D		
61	50	5,6	5,5	WAT-50x61x5,6-E8D	70	13	2,5	WAT-70x75x13-E8D	
	50	9,7	5,5	WAT-50x61x9,7-E8D	70	15	2,5	WAT-70x75x15-E8D	
	56	5,6	2,5	WAT-56x61x5,6-E8D	70	20	2,5	WAT-70x75x20-E8D	
	56	9,7	2,5	WAT-56x61x9,7-E8D	70	20,3	2,5	WAT-70x75x20,3-E8D	
	56	15	2,5	WAT-56x61x15-E8D	76	70	13	3	WAT-70x76x13-E8D
	63	58	5,6	2,5		WAT-58x63x5,6-E8D	70	15,3	3
58		8	2,5	WAT-58x63x8-E8D		70	19,5	3	WAT-70x76x19,5-E8D
58		9,7	2,5	WAT-58x63x9,7-E8D		71	20	2,5	WAT-71x76x20-E8D
58		15	2,5	WAT-58x63x15-E8D	80	74	20,3	3	WAT-74x80x20,3-E8D
65	59	13	3	WAT-59x65x13-E8D		74	25,5	3	WAT-74x80x25,5-E8D
	60	5,6	2,5	WAT-60x65x5,6-E8D	75	5,6	2,5	WAT-75x80x5,6-E8D	
	60	9,7	2,5	WAT-60x65x9,7-E8D	75	9,7	2,5	WAT-75x80x9,7-E8D	
	60	10	2,5	WAT-60x65x10-E8D	75	10	2,5	WAT-75x80x10-E8D	
	60	15	2,5	WAT-60x65x15-E8D	75	15	2,5	WAT-75x80x15-E8D	
	60	15,3	2,5	WAT-60x65x15,3-E8D	75	20	2,5	WAT-75x80x20-E8D	
	60	20	2,5	WAT-60x65x20-E8D	75	20,3	2,5	WAT-75x80x20,3-E8D	
	60	20,3	2,5	WAT-60x65x20,3-E8D	75	30,5	2,5	WAT-75x80x30,5-E8D	
	60	25	2,5	WAT-60x65x25-E8D	85	79	13	3	WAT-79x85x13-E8D
	66	60	10	3		WAT-60x66x10-E8D	79	15	3
60		13	3	WAT-60x66x13-E8D		79	25	3	WAT-79x85x25-E8D
61		20	2,5	WAT-61x66x20-E8D		80	9,7	2,5	WAT-80x85x9,7-E8D
61		20,3	2,5	WAT-61x66x20,3-E8D	80	13	2,5	WAT-80x85x13-E8D	
68	63	5,6	2,5	WAT-63x68x5,6-E8D	80	15	2,5	WAT-80x85x15-E8D	
	63	9,7	2,5	WAT-63x68x9,7-E8D	80	20	2,5	WAT-80x85x20-E8D	
	63	10	2,5	WAT-63x68x10-E8D	80	25	2,5	WAT-80x85x25-E8D	
	63	13	2,5	WAT-63x68x13-E8D	86	80	13	3	WAT-80x86x13-E8D
	63	15	2,5	WAT-63x68x15-E8D		80	19,5	3	WAT-80x86x19,5-E8D
	63	20	2,5	WAT-63x68x20-E8D					
69	64	10	2,5	WAT-64x69x10-E8D					
	64	20	2,5	WAT-64x69x20-E8D					
	64	20,3	2,5	WAT-64x69x20,3-E8D					

¹⁾ Adjustments according to tolerances provided for rod or piston seals are possible, however, the maximum e-gap also need to be considered (→ Gap extrusion, page 34)



5.1 WAT rod or piston guide rings, metric sizes

D 90 – 165 mm

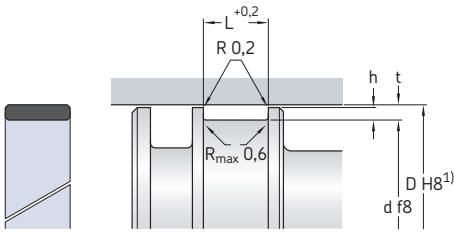

Piston application
(dynamic on the outside surface)

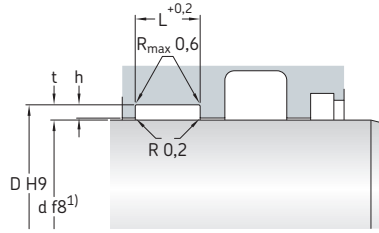

Rod application
(dynamic on the inside surface)

$h \geq t/2$

Dimensions				Designation
D	d	L	t	
mm				-
90	84	13	3	WAT-84x90x13-E8D
	84	15	3	WAT-84x90x15-E8D
	84	15,3	3	WAT-84x90x15.3-E8D
	84	25	3	WAT-84x90x25-E8D
	84	25,5	3	WAT-84x90x25.5-E8D
		85	9,7	2,5
	85	10	2,5	WAT-85x90x10-E8D
	85	15	2,5	WAT-85x90x15-E8D
	85	30	2,5	WAT-85x90x30-E8D
93	88	10	2,5	WAT-88x93x10-E8D
	88	13	2,5	WAT-88x93x13-E8D
95	89	13	3	WAT-89x95x13-E8D
	89	15	3	WAT-89x95x15-E8D
96	90	9,7	2,5	WAT-90x95x9.7-E8D
	90	10	2,5	WAT-90x95x10-E8D
	90	13	2,5	WAT-90x95x13-E8D
	90	15	2,5	WAT-90x95x15-E8D
	90	20	2,5	WAT-90x95x20-E8D
		90	10	3
	90	13	3	WAT-90x96x13-E8D
	90	19,5	3	WAT-90x96x19.5-E8D
100	94	15	3	WAT-94x100x15-E8D
	94	15,3	3	WAT-94x100x15.3-E8D
	94	25	3	WAT-94x100x25-E8D
	94	25,5	3	WAT-94x100x25.5-E8D
	94	30,5	3	WAT-94x100x30.5-E8D
		95	5,6	2,5
	95	9,7	2,5	WAT-95x100x9.7-E8D
	95	10	2,5	WAT-95x100x10-E8D
	95	13	2,5	WAT-95x100x13-E8D
	95	15	2,5	WAT-95x100x15-E8D
	95	15,3	2,5	WAT-95x100x15.3-E8D

Dimensions				Designation
D	d	L	t	
mm				-
101	95	13	3	WAT-95x101x13-E8D
	95	19,5	3	WAT-95x101x19.5-E8D
105	99	10	3	WAT-99x105x10-E8D
	99	25	3	WAT-99x105x25-E8D
	100	9,7	2,5	WAT-100x105x9.7-E8D
	100	15	2,5	WAT-100x105x15-E8D
	100	25	2,5	WAT-100x105x25-E8D
	100	30,5	2,5	WAT-100x105x30.5-E8D
107	101	15	3	WAT-101x107x15-E8D
110	102	15	4	WAT-102x110x15-E8D
	102	25	4	WAT-102x110x25-E8D
	104	13	3	WAT-104x110x13-E8D
	104	15	3	WAT-104x110x15-E8D
	104	25	3	WAT-104x110x25-E8D
	104	25,5	3	WAT-104x110x25.5-E8D
112	105	8	2,5	WAT-105x110x8-E8D
	105	9,7	2,5	WAT-105x110x9.7-E8D
	105	13	2,5	WAT-105x110x13-E8D
	105	15	2,5	WAT-105x110x15-E8D
	106	15	3	WAT-106x112x15-E8D
115	106	30	3	WAT-106x112x30-E8D
	107	10	2,5	WAT-107x112x10-E8D
	107	13	2,5	WAT-107x112x13-E8D
115	107	13	4	WAT-107x115x13-E8D
	109	19,5	3	WAT-109x115x19.5-E8D
	109	30	3	WAT-109x115x30-E8D
	110	9,7	2,5	WAT-110x115x9.7-E8D
	110	15	2,5	WAT-110x115x15-E8D
	110	20	2,5	WAT-110x115x20-E8D
115	110	25	2,5	WAT-110x115x25-E8D
	110	30	2,5	WAT-110x115x30-E8D

¹⁾ Adjustments according to tolerances provided for rod or piston seals are possible, however, the maximum e-gap also need to be considered (→ Gap extrusion, page 34)

Dimensions				Designation
D	d	L	t	
mm				-
116	110	9,7	3	WAT-110x116x9.7-E8D
	110	25,5	3	WAT-110x116x25.5-E8D
120	112	25	4	WAT-112x120x25-E8D
	114	13	3	WAT-114x120x13-E8D
	114	15	3	WAT-114x120x15-E8D
	114	15,3	3	WAT-114x120x15.3-E8D
	114	20	3	WAT-114x120x20-E8D
	114	30	3	WAT-114x120x30-E8D
	114	30,5	3	WAT-114x120x30.5-E8D
	115	9,7	2,5	WAT-115x120x9.7-E8D
	115	13	2,5	WAT-115x120x13-E8D
	115	15	2,5	WAT-115x120x15-E8D
	115	25	2,5	WAT-115x120x25-E8D
121	115	20,3	3	WAT-115x121x20.3-E8D
	115	30,5	3	WAT-115x121x30.5-E8D
125	117	25	4	WAT-117x125x25-E8D
	119	15	3	WAT-119x125x15-E8D
	119	19,5	3	WAT-119x125x19.5-E8D
	119	25,5	3	WAT-119x125x25.5-E8D
	119	30	3	WAT-119x125x30-E8D
	119	30,5	3	WAT-119x125x30.5-E8D
	120	5,6	2,5	WAT-120x125x5.6-E8D
	120	8	2,5	WAT-120x125x8-E8D
	120	9,7	2,5	WAT-120x125x9.7-E8D
	120	15	2,5	WAT-120x125x15-E8D
	120	20	2,5	WAT-120x125x20-E8D
120	25	2,5	WAT-120x125x25-E8D	
126	120	10	3	WAT-120x126x10-E8D
	120	15,3	3	WAT-120x126x15.3-E8D
	120	20,3	3	WAT-120x126x20.3-E8D
130	123	15	3,5	WAT-123x130x15-E8D
	123	30	3,5	WAT-123x130x30-E8D
	124	10	3	WAT-124x130x10-E8D
	124	13	3	WAT-124x130x13-E8D
	124	30,5	3	WAT-124x130x30.5-E8D
125	125	8	2,5	WAT-125x130x8-E8D
	125	9,7	2,5	WAT-125x130x9.7-E8D
	125	15	2,5	WAT-125x130x15-E8D
	125	15,3	2,5	WAT-125x130x15.3-E8D
	125	25,5	2,5	WAT-125x130x25.5-E8D
135	129	19,5	3	WAT-129x135x19.5-E8D
	130	9,7	2,5	WAT-130x135x9.7-E8D
	130	15	2,5	WAT-130x135x15-E8D
	130	20	2,5	WAT-130x135x20-E8D
	130	30	2,5	WAT-130x135x30-E8D
136	130	9,7	3	WAT-130x136x9.7-E8D
	130	15,3	3	WAT-130x136x15.3-E8D
	130	25,5	3	WAT-130x136x25.5-E8D

Dimensions				Designation
D	d	L	t	
mm				-
140	132	20	4	WAT-132x140x20-E8D
	132	25	4	WAT-132x140x25-E8D
	133	20	3,5	WAT-133x140x20-E8D
134	134	13	3	WAT-134x140x13-E8D
	134	15,3	3	WAT-134x140x15.3-E8D
	134	20,3	3	WAT-134x140x20.3-E8D
	134	25,5	3	WAT-134x140x25.5-E8D
135	135	9,7	2,5	WAT-135x140x9.7-E8D
	135	13	2,5	WAT-135x140x13-E8D
	135	15	2,5	WAT-135x140x15-E8D
	135	15,3	2,5	WAT-135x140x15.3-E8D
	135	20	2,5	WAT-135x140x20-E8D
145	139	13	3	WAT-139x145x13-E8D
	139	19,5	3	WAT-139x145x19.5-E8D
	139	30,5	3	WAT-139x145x30.5-E8D
140	140	9,7	2,5	WAT-140x145x9.7-E8D
	140	15	2,5	WAT-140x145x15-E8D
	140	20	2,5	WAT-140x145x20-E8D
	140	25	2,5	WAT-140x145x25-E8D
	140	30	2,5	WAT-140x145x30-E8D
	140	30,5	2,5	WAT-140x145x30.5-E8D
146	140	13	3	WAT-140x146x13-E8D
	140	15,3	3	WAT-140x146x15.3-E8D
150	142	20	4	WAT-142x150x20-E8D
	142	25	4	WAT-142x150x25-E8D
	143	20	3,5	WAT-143x150x20-E8D
	144	13	3	WAT-144x150x13-E8D
	144	25,5	3	WAT-144x150x25.5-E8D
145	145	9,7	2,5	WAT-145x150x9.7-E8D
	145	13	2,5	WAT-145x150x13-E8D
	145	15	2,5	WAT-145x150x15-E8D
	145	20	2,5	WAT-145x150x20-E8D
	145	25	2,5	WAT-145x150x25-E8D
155	150	15	2,5	WAT-150x155x15-E8D
	150	20	2,5	WAT-150x155x20-E8D
	150	30,5	2,5	WAT-150x155x30.5-E8D
157	150	40	3,5	WAT-150x157x40-E8D
160	152	15,3	4	WAT-152x160x15.3-E8D
	152	25	4	WAT-152x160x25-E8D
	153	20	3,5	WAT-153x160x20-E8D
	153	40	3,5	WAT-153x160x40-E8D
	154	19,5	3	WAT-154x160x19.5-E8D
	154	25,5	3	WAT-154x160x25.5-E8D
155	155	9,7	2,5	WAT-155x160x9.7-E8D
	155	15	2,5	WAT-155x160x15-E8D
	155	15,3	2,5	WAT-155x160x15.3-E8D
	155	20	2,5	WAT-155x160x20-E8D
	155	25	2,5	WAT-155x160x25-E8D
	155	25,5	2,5	WAT-155x160x25.5-E8D
165	157	45	4	WAT-157x165x45-E8D
	159	19,5	3	WAT-159x165x19.5-E8D
	160	9,7	2,5	WAT-160x165x9.7-E8D
	160	15	2,5	WAT-160x165x15-E8D
	160	30,5	2,5	WAT-160x165x30.5-E8D

5.1

5.1 WAT rod or piston guide rings, metric sizes

D 170 – 260 mm

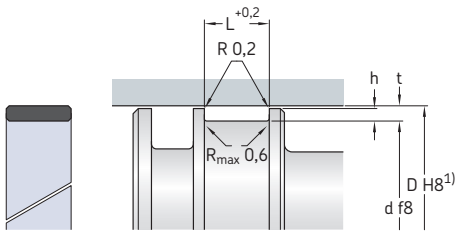

Piston application
(dynamic on the outside surface)

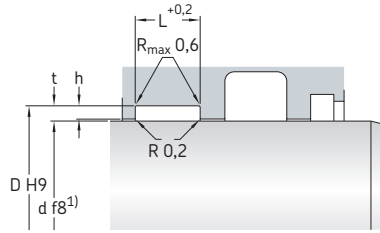

Rod application
(dynamic on the inside surface)

$h \geq t/2$

Dimensions				Designation	Dimensions				Designation	
D	d	L	t		D	d	L	t		
mm				-	mm				-	
170	162	15	4	WAT-162x170x15-E8D	190	182	25	4	WAT-182x190x25-E8D	
	162	25	4	WAT-162x170x25-E8D		182	45	4	WAT-182x190x45-E8D	
	162	45	4	WAT-162x170x45-E8D		184	15	3	WAT-184x190x15-E8D	
	164	9,7	3	WAT-164x170x9.7-E8D		185	15,3	2,5	WAT-185x190x15.3-E8D	
	164	25,5	3	WAT-164x170x25.5-E8D		185	25,5	2,5	WAT-185x190x25.5-E8D	
	165	9,7	2,5	WAT-165x170x9.7-E8D		195	190	15	2,5	WAT-190x195x15-E8D
	165	15	2,5	WAT-165x170x15-E8D			190	25	2,5	WAT-190x195x25-E8D
	165	15,3	2,5	WAT-165x170x15.3-E8D		200	192	25	4	WAT-192x200x25-E8D
	165	20	2,5	WAT-165x170x20-E8D			192	45	4	WAT-192x200x45-E8D
	165	20,3	2,5	WAT-165x170x20.3-E8D			194	15,3	3	WAT-194x200x15.3-E8D
175	170	15	2,5	WAT-170x175x15-E8D	194		20,3	3	WAT-194x200x20.3-E8D	
175	170	25	2,5	WAT-170x175x25-E8D	195	9,7	2,5	WAT-195x200x9.7-E8D		
	170	30,5	2,5	WAT-170x175x30.5-E8D	195	15	2,5	WAT-195x200x15-E8D		
	180	172	15	4	WAT-172x180x15-E8D	195	15,3	2,5	WAT-195x200x15.3-E8D	
		172	20	4	WAT-172x180x20-E8D	195	20	2,5	WAT-195x200x20-E8D	
		172	25	4	WAT-172x180x25-E8D	195	25	2,5	WAT-195x200x25-E8D	
172		45	4	WAT-172x180x45-E8D	195	25,5	2,5	WAT-195x200x25.5-E8D		
174	19,5	3	WAT-174x180x19.5-E8D	204	196	25	4	WAT-196x204x25-E8D		
175	9,7	2,5	WAT-175x180x9.7-E8D		205	197	50	4	WAT-197x205x50-E8D	
175	15	2,5	WAT-175x180x15-E8D	200		15	2,5	WAT-200x205x15-E8D		
175	15,3	2,5	WAT-175x180x15.3-E8D	200		25	2,5	WAT-200x205x25-E8D		
175	20,3	2,5	WAT-175x180x20.3-E8D	208	200	25	4	WAT-200x208x25-E8D		
185	177	45	4		WAT-177x185x45-E8D	202	25	4	WAT-202x210x25-E8D	
	179	9,7	3		WAT-179x185x9.7-E8D	202	50	4	WAT-202x210x50-E8D	
	180	9,7	2,5	WAT-180x185x9.7-E8D	205	15	2,5	WAT-205x210x15-E8D		
	180	15	2,5	WAT-180x185x15-E8D	215	209	25,5	3	WAT-209x215x25.5-E8D	
	180	25,5	2,5	WAT-180x185x25.5-E8D		210	15	2,5	WAT-210x215x15-E8D	
180	25,5	2,5	WAT-180x185x25.5-E8D	210		20,3	2,5	WAT-210x215x20.3-E8D		
186	180	15,3	3	WAT-180x186x15.3-E8D						
188	180	25	4	WAT-180x188x25-E8D						

¹⁾ Adjustments according to tolerances provided for rod or piston seals are possible, however, the maximum e-gap also need to be considered (→ Gap extrusion, page 34)

Dimensions				Designation
D	d	L	t	
mm				-
218	210	25	4	WAT-210x218x25-E8D
220	212	50	4	WAT-212x220x50-E8D
	215	9,7	2,5	WAT-215x220x9.7-E8D
	215	15	2,5	WAT-215x220x15-E8D
	215	15,3	2,5	WAT-215x220x15.3-E8D
224	216	25	4	WAT-216x224x25-E8D
	216	50	4	WAT-216x224x50-E8D
225	217	25	4	WAT-217x225x25-E8D
	217	50	4	WAT-217x225x50-E8D
	219	15,3	3	WAT-219x225x15.3-E8D
	220	15	2,5	WAT-220x225x15-E8D
	220	25	2,5	WAT-220x225x25-E8D
230	222	20	4	WAT-222x230x20-E8D
	222	30	4	WAT-222x230x30-E8D
	222	55	4	WAT-222x230x55-E8D
	225	20,3	2,5	WAT-225x230x20.3-E8D
235	229	25,5	3	WAT-229x235x25.5-E8D
240	232	30	4	WAT-232x240x30-E8D
	232	55	4	WAT-232x240x55-E8D
	235	20,3	2,5	WAT-235x240x20.3-E8D
	235	25,5	2,5	WAT-235x240x25.5-E8D
250	242	20,3	4	WAT-242x250x20.3-E8D
	242	30	4	WAT-242x250x30-E8D
	242	55	4	WAT-242x250x55-E8D
	244	15,3	3	WAT-244x250x15.3-E8D
	245	9,7	2,5	WAT-245x250x9.7-E8D
	245	15	2,5	WAT-245x250x15-E8D
255	250	15	2,5	WAT-250x255x15-E8D
	250	25	2,5	WAT-250x255x25-E8D
260	252	20,3	4	WAT-252x260x20.3-E8D
	252	30,5	4	WAT-252x260x30.5-E8D

5.2 WAT rod or piston guide rings, inch sizes

D 1 – 2.25 in.

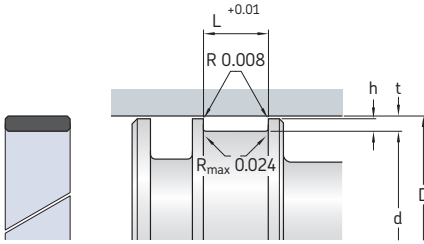

Diameter tolerances		
Cylinder bore	Tolerances ¹⁾	
D	D	d
in.	in.	
1 to 4.875	+0.002	-0.002
5 to 7.75	+0.004	-0.003
8 to 10.5	+0.006	-0.004

Piston application
(dynamic on the outside surface)

$h \geq t/2$

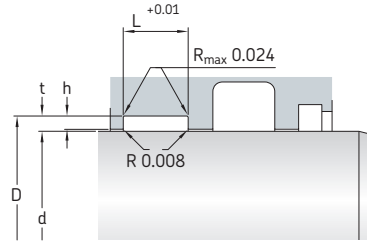

Diameter tolerances		
Housing groove	Tolerances ¹⁾	
D	D	d
in.	in.	
1 to 5.625	+0.002	-0.002
5.75 to 10.5	+0.003	-0.004

Rod application
(dynamic on the inside surface)

Dimensions				Designation	
D	d	L	t		
in.	-				
1	0.813	0.25	0.093	WAT93-1000-250-E8D	
	0.813	0.312	0.093	WAT93-1000-312-E8D	
	0.813	0.375	0.093	WAT93-1000-375-E8D	
	0.813	0.5	0.093	WAT93-1000-500-E8D	
	0.813	0.625	0.093	WAT93-1000-625-E8D	
	0.875	0.25	0.062	WAT62-1000-250-E8D	
	0.875	0.312	0.062	WAT62-1000-312-E8D	
	0.875	0.375	0.062	WAT62-1000-375-E8D	
	0.875	0.5	0.062	WAT62-1000-500-E8D	
	0.875	0.625	0.062	WAT62-1000-625-E8D	
1.125	0.938	0.25	0.093	WAT93-1125-250-E8D	
	0.938	0.312	0.093	WAT93-1125-312-E8D	
	0.938	0.375	0.093	WAT93-1125-375-E8D	
	0.938	0.5	0.093	WAT93-1125-500-E8D	
	0.938	0.625	0.093	WAT93-1125-625-E8D	
	1	0.187	0.062	WAT62-1125-187-E8D	
	1	0.25	0.062	WAT62-1125-250-E8D	
	1	0.312	0.062	WAT62-1125-312-E8D	
	1	0.375	0.062	WAT62-1125-375-E8D	
	1	0.5	0.062	WAT62-1125-500-E8D	
1	0.625	0.062	WAT62-1125-625-E8D		
1.25	1	0.187	0.125	WAT125-1250-187-E8D	
	1	0.25	0.125	WAT125-1250-250-E8D	
	1	0.312	0.125	WAT125-1250-312-E8D	
	1	0.375	0.125	WAT125-1250-375-E8D	
	1	0.5	0.125	WAT125-1250-500-E8D	
	1	0.625	0.125	WAT125-1250-625-E8D	
	1	0.75	0.125	WAT125-1250-750-E8D	

Dimensions				Designation	
D	d	L	t		
in.	-				
1.25	1.063	0.25	0.093	WAT93-1250-250-E8D	
	1.063	0.312	0.093	WAT93-1250-312-E8D	
	1.063	0.375	0.093	WAT93-1250-375-E8D	
	1.063	0.5	0.093	WAT93-1250-500-E8D	
	1.063	0.625	0.093	WAT93-1250-625-E8D	
	1.063	0.75	0.093	WAT93-1250-750-E8D	
	1.125	0.187	0.062	WAT62-1250-187-E8D	
	1.125	0.25	0.062	WAT62-1250-250-E8D	
	1.125	0.312	0.062	WAT62-1250-312-E8D	
	1.125	0.375	0.062	WAT62-1250-375-E8D	
1.125	0.5	0.062	WAT62-1250-500-E8D		
1.125	0.625	0.062	WAT62-1250-625-E8D		
1.125	0.75	0.062	WAT62-1250-750-E8D		
1.5	1.25	0.187	0.125	WAT125-1500-187-E8D	
	1.25	0.25	0.125	WAT125-1500-250-E8D	
	1.25	0.312	0.125	WAT125-1500-312-E8D	
	1.25	0.375	0.125	WAT125-1500-375-E8D	
	1.25	0.5	0.125	WAT125-1500-500-E8D	
	1.25	0.625	0.125	WAT125-1500-625-E8D	
	1.25	0.75	0.125	WAT125-1500-750-E8D	
	1.25	0.875	0.125	WAT125-1500-875-E8D	
	1.25	1	0.125	WAT125-1500-1000-E8D	
	1.313	0.25	0.093	WAT93-1500-250-E8D	
1.313	0.312	0.093	WAT93-1500-312-E8D		
1.313	0.375	0.093	WAT93-1500-375-E8D		
1.313	0.5	0.093	WAT93-1500-500-E8D		

¹⁾ Adjustments according to tolerances provided for rod or piston seals are possible, however, the maximum e-gap also need to be considered (→ Gap extrusion, page 34)

Dimensions				Designation
D	d	L	t	

in.				-
-----	--	--	--	---

1.5 cont.	1.313	0.625	0.093	WAT93-1500-625-E8D
	1.313	0.75	0.093	WAT93-1500-750-E8D
	1.313	0.875	0.093	WAT93-1500-875-E8D
	1.313	1	0.093	WAT93-1500-1000-E8D

1.375	0.187	0.062	WAT62-1500-187-E8D
1.375	0.25	0.062	WAT62-1500-250-E8D
1.375	0.312	0.062	WAT62-1500-312-E8D
1.375	0.375	0.062	WAT62-1500-375-E8D
1.375	0.5	0.062	WAT62-1500-500-E8D

1.375	0.625	0.062	WAT62-1500-625-E8D
1.375	0.75	0.062	WAT62-1500-750-E8D
1.375	0.875	0.062	WAT62-1500-875-E8D
1.375	1	0.062	WAT62-1500-1000-E8D

1.75	1.5	0.25	0.125	WAT125-1750-250-E8D
	1.5	0.312	0.125	WAT125-1750-312-E8D
	1.5	0.375	0.125	WAT125-1750-375-E8D
	1.5	0.5	0.125	WAT125-1750-500-E8D

1.5	0.625	0.125	WAT125-1750-625-E8D
1.5	0.75	0.125	WAT125-1750-750-E8D
1.5	0.875	0.125	WAT125-1750-875-E8D
1.5	1	0.125	WAT125-1750-1000-E8D

1.563	0.25	0.093	WAT93-1750-250-E8D
1.563	0.312	0.093	WAT93-1750-312-E8D
1.563	0.375	0.093	WAT93-1750-375-E8D
1.563	0.5	0.093	WAT93-1750-500-E8D

1.563	0.625	0.093	WAT93-1750-625-E8D
1.563	0.75	0.093	WAT93-1750-750-E8D
1.563	0.875	0.093	WAT93-1750-875-E8D
1.563	1	0.093	WAT93-1750-1000-E8D

1.625	0.25	0.062	WAT62-1750-250-E8D
1.625	0.312	0.062	WAT62-1750-312-E8D
1.625	0.375	0.062	WAT62-1750-375-E8D
1.625	0.5	0.062	WAT62-1750-500-E8D

1.625	0.625	0.062	WAT62-1750-625-E8D
1.625	0.75	0.062	WAT62-1750-750-E8D
1.625	0.875	0.062	WAT62-1750-875-E8D
1.625	1	0.062	WAT62-1750-1000-E8D

2	1.625	0.25	0.187	WAT187-2000-250-E8D
	1.625	0.312	0.187	WAT187-2000-312-E8D
	1.625	0.375	0.187	WAT187-2000-375-E8D
	1.625	0.5	0.187	WAT187-2000-500-E8D
	1.625	0.625	0.187	WAT187-2000-625-E8D

1.625	0.75	0.187	WAT187-2000-750-E8D
1.625	0.875	0.187	WAT187-2000-875-E8D
1.625	1	0.187	WAT187-2000-1000-E8D
1.625	1.25	0.187	WAT187-2000-1250-E8D
1.625	1.5	0.187	WAT187-2000-1500-E8D

1.75	0.25	0.125	WAT125-2000-250-E8D
1.75	0.312	0.125	WAT125-2000-312-E8D
1.75	0.375	0.125	WAT125-2000-375-E8D
1.75	0.5	0.125	WAT125-2000-500-E8D
1.75	0.625	0.125	WAT125-2000-625-E8D

Dimensions				Designation
D	d	L	t	

in.				-
-----	--	--	--	---

2 cont.	1.75	0.75	0.125	WAT125-2000-750-E8D
	1.75	0.875	0.125	WAT125-2000-875-E8D
	1.75	1	0.125	WAT125-2000-1000-E8D
	1.75	1.25	0.125	WAT125-2000-1250-E8D
	1.75	1.5	0.125	WAT125-2000-1500-E8D

1.813	0.25	0.093	WAT93-2000-250-E8D
1.813	0.312	0.093	WAT93-2000-312-E8D
1.813	0.375	0.093	WAT93-2000-375-E8D
1.813	0.5	0.093	WAT93-2000-500-E8D
1.813	0.625	0.093	WAT93-2000-625-E8D

1.813	0.75	0.093	WAT93-2000-750-E8D
1.813	0.875	0.093	WAT93-2000-875-E8D
1.813	1	0.093	WAT93-2000-1000-E8D
1.813	1.25	0.093	WAT93-2000-1250-E8D
1.813	1.5	0.093	WAT93-2000-1500-E8D

1.875	0.25	0.062	WAT62-2000-250-E8D
1.875	0.312	0.062	WAT62-2000-312-E8D
1.875	0.375	0.062	WAT62-2000-375-E8D
1.875	0.5	0.062	WAT62-2000-500-E8D
1.875	0.625	0.062	WAT62-2000-625-E8D

1.875	0.75	0.062	WAT62-2000-750-E8D
1.875	0.875	0.062	WAT62-2000-875-E8D
1.875	1	0.062	WAT62-2000-1000-E8D
1.875	1.25	0.062	WAT62-2000-1250-E8D
1.875	1.5	0.062	WAT62-2000-1500-E8D

2.25	1.875	0.25	0.187	WAT187-2250-250-E8D
	1.875	0.312	0.187	WAT187-2250-312-E8D
	1.875	0.375	0.187	WAT187-2250-375-E8D
	1.875	0.5	0.187	WAT187-2250-500-E8D
	1.875	0.625	0.187	WAT187-2250-625-E8D

1.875	0.75	0.187	WAT187-2250-750-E8D
1.875	0.875	0.187	WAT187-2250-875-E8D
1.875	1	0.187	WAT187-2250-1000-E8D
1.875	1.25	0.187	WAT187-2250-1250-E8D
1.875	1.5	0.187	WAT187-2250-1500-E8D

2	0.25	0.125	WAT125-2250-250-E8D
2	0.312	0.125	WAT125-2250-312-E8D
2	0.375	0.125	WAT125-2250-375-E8D
2	0.5	0.125	WAT125-2250-500-E8D
2	0.625	0.125	WAT125-2250-625-E8D

2	0.75	0.125	WAT125-2250-750-E8D
2	0.875	0.125	WAT125-2250-875-E8D
2	1	0.125	WAT125-2250-1000-E8D
2	1.25	0.125	WAT125-2250-1250-E8D
2	1.5	0.125	WAT125-2250-1500-E8D

2.063	0.25	0.093	WAT93-2250-250-E8D
2.063	0.312	0.093	WAT93-2250-312-E8D
2.063	0.375	0.093	WAT93-2250-375-E8D
2.063	0.5	0.093	WAT93-2250-500-E8D
2.063	0.625	0.093	WAT93-2250-625-E8D

2.063	0.75	0.093	WAT93-2250-750-E8D
2.063	0.875	0.093	WAT93-2250-875-E8D
2.063	1	0.093	WAT93-2250-1000-E8D
2.063	1.25	0.093	WAT93-2250-1250-E8D
2.063	1.5	0.093	WAT93-2250-1500-E8D



5.2 WAT rod or piston guide rings, inch sizes

D 2.25 – 3 in.

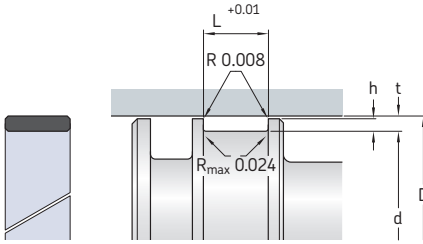

Diameter tolerances		
Cylinder bore	Tolerances ¹⁾	
D	D	d
in.	in.	
1 to 4.875	+0.002	-0.002
5 to 7.75	+0.004	-0.003
8 to 10.5	+0.006	-0.004

Piston application
(dynamic on the outside surface)

$h \geq t/2$

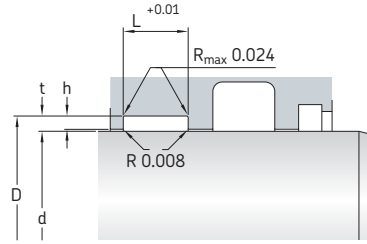

Diameter tolerances		
Housing groove	Tolerances ¹⁾	
D	D	d
in.	in.	
1 to 5.625	+0.002	-0.002
5.75 to 10.5	+0.003	-0.004

Rod application
(dynamic on the inside surface)

Dimensions		Designation	
D	d	L	t
in.			
2.25	0.25	0.062	WAT62-2250-250-E8D
2.25	0.312	0.062	WAT62-2250-312-E8D
2.25	0.375	0.062	WAT62-2250-375-E8D
2.25	0.5	0.062	WAT62-2250-500-E8D
2.25	0.625	0.062	WAT62-2250-625-E8D
2.25	0.75	0.062	WAT62-2250-750-E8D
2.25	0.875	0.062	WAT62-2250-875-E8D
2.25	1	0.062	WAT62-2250-1000-E8D
2.25	1.25	0.062	WAT62-2250-1250-E8D
2.25	1.5	0.062	WAT62-2250-1500-E8D
2.5	0.25	0.187	WAT187-2500-250-E8D
2.5	0.312	0.187	WAT187-2500-312-E8D
2.5	0.375	0.187	WAT187-2500-375-E8D
2.5	0.5	0.187	WAT187-2500-500-E8D
2.5	0.625	0.187	WAT187-2500-625-E8D
2.5	0.75	0.187	WAT187-2500-750-E8D
2.5	0.875	0.187	WAT187-2500-875-E8D
2.5	1	0.187	WAT187-2500-1000-E8D
2.5	1.25	0.187	WAT187-2500-1250-E8D
2.5	1.5	0.187	WAT187-2500-1500-E8D
2.5	1.75	0.187	WAT187-2500-1750-E8D
2.25	0.25	0.125	WAT125-2500-250-E8D
2.25	0.312	0.125	WAT125-2500-312-E8D
2.25	0.375	0.125	WAT125-2500-375-E8D
2.25	0.5	0.125	WAT125-2500-500-E8D
2.25	0.625	0.125	WAT125-2500-625-E8D
2.25	0.75	0.125	WAT125-2500-750-E8D

Dimensions		Designation	
D	d	L	t
in.			
2.5	0.875	0.125	WAT125-2500-875-E8D
2.25	1	0.125	WAT125-2500-1000-E8D
2.25	1.25	0.125	WAT125-2500-1250-E8D
2.25	1.5	0.125	WAT125-2500-1500-E8D
2.25	1.75	0.125	WAT125-2500-1750-E8D
2.313	0.25	0.093	WAT93-2500-250-E8D
2.313	0.312	0.093	WAT93-2500-312-E8D
2.313	0.375	0.093	WAT93-2500-375-E8D
2.313	0.5	0.093	WAT93-2500-500-E8D
2.313	0.625	0.093	WAT93-2500-625-E8D
2.313	0.75	0.093	WAT93-2500-750-E8D
2.313	0.875	0.093	WAT93-2500-875-E8D
2.313	1	0.093	WAT93-2500-1000-E8D
2.313	1.25	0.093	WAT93-2500-1250-E8D
2.313	1.5	0.093	WAT93-2500-1500-E8D
2.313	1.75	0.093	WAT93-2500-1750-E8D
2.375	0.25	0.062	WAT62-2500-250-E8D
2.375	0.312	0.062	WAT62-2500-312-E8D
2.375	0.375	0.062	WAT62-2500-375-E8D
2.375	0.5	0.062	WAT62-2500-500-E8D
2.375	0.625	0.062	WAT62-2500-625-E8D
2.375	0.75	0.062	WAT62-2500-750-E8D
2.375	0.875	0.062	WAT62-2500-875-E8D
2.375	1	0.062	WAT62-2500-1000-E8D
2.375	1.25	0.062	WAT62-2500-1250-E8D
2.375	1.5	0.062	WAT62-2500-1500-E8D
2.375	1.75	0.062	WAT62-2500-1750-E8D

¹⁾ Adjustments according to tolerances provided for rod or piston seals are possible, however, the maximum e-gap also need to be considered (→ Gap extrusion, page 34)

Dimensions				Designation
D	d	L	t	
in.				-
2.625	2.25	0.25	0.187	WAT187-2625-250-E8D
	2.25	0.312	0.187	WAT187-2625-312-E8D
	2.25	0.375	0.187	WAT187-2625-375-E8D
	2.25	0.5	0.187	WAT187-2625-500-E8D
	2.25	0.625	0.187	WAT187-2625-625-E8D
	2.25	0.75	0.187	WAT187-2625-750-E8D
	2.25	0.875	0.187	WAT187-2625-875-E8D
	2.25	1	0.187	WAT187-2625-1000-E8D
	2.25	1.25	0.187	WAT187-2625-1250-E8D
	2.25	1.5	0.187	WAT187-2625-1500-E8D
	2.25	1.75	0.187	WAT187-2625-1750-E8D
	2.375	0.25	0.125	WAT125-2625-250-E8D
2.375	0.312	0.125	WAT125-2625-312-E8D	
2.375	0.375	0.125	WAT125-2625-375-E8D	
2.375	0.5	0.125	WAT125-2625-500-E8D	
2.375	0.625	0.125	WAT125-2625-625-E8D	
2.375	0.75	0.125	WAT125-2625-750-E8D	
2.375	0.875	0.125	WAT125-2625-875-E8D	
2.375	1	0.125	WAT125-2625-1000-E8D	
2.375	1.25	0.125	WAT125-2625-1250-E8D	
2.375	1.5	0.125	WAT125-2625-1500-E8D	
2.375	1.75	0.125	WAT125-2625-1750-E8D	
2.438	0.25	0.093	WAT93-2625-250-E8D	
2.438	0.312	0.093	WAT93-2625-312-E8D	
2.438	0.375	0.093	WAT93-2625-375-E8D	
2.438	0.5	0.093	WAT93-2625-500-E8D	
2.438	0.625	0.093	WAT93-2625-625-E8D	
2.438	0.75	0.093	WAT93-2625-750-E8D	
2.438	0.875	0.093	WAT93-2625-875-E8D	
2.438	1	0.093	WAT93-2625-1000-E8D	
2.438	1.25	0.093	WAT93-2625-1250-E8D	
2.438	1.5	0.093	WAT93-2625-1500-E8D	
2.438	1.75	0.093	WAT93-2625-1750-E8D	
2.5	0.25	0.062	WAT62-2625-250-E8D	
2.5	0.312	0.062	WAT62-2625-312-E8D	
2.5	0.375	0.062	WAT62-2625-375-E8D	
2.5	0.5	0.062	WAT62-2625-500-E8D	
2.5	0.625	0.062	WAT62-2625-625-E8D	
2.5	0.75	0.062	WAT62-2625-750-E8D	
2.5	0.875	0.062	WAT62-2625-875-E8D	
2.5	1	0.062	WAT62-2625-1000-E8D	
2.5	1.25	0.062	WAT62-2625-1250-E8D	
2.5	1.5	0.062	WAT62-2625-1500-E8D	
2.5	1.75	0.062	WAT62-2625-1750-E8D	
2.75	2.375	0.25	0.187	WAT187-2750-250-E8D
	2.375	0.312	0.187	WAT187-2750-312-E8D
	2.375	0.375	0.187	WAT187-2750-375-E8D
	2.375	0.5	0.187	WAT187-2750-500-E8D
	2.375	0.625	0.187	WAT187-2750-625-E8D
	2.375	0.75	0.187	WAT187-2750-750-E8D
	2.375	0.875	0.187	WAT187-2750-875-E8D
	2.375	1	0.187	WAT187-2750-1000-E8D
	2.375	1.25	0.187	WAT187-2750-1250-E8D
	2.375	1.5	0.187	WAT187-2750-1500-E8D
	2.375	1.75	0.187	WAT187-2750-1750-E8D
	2.375	2	0.187	WAT187-2750-2000-E8D
2.5	0.25	0.125	WAT125-2750-250-E8D	
2.5	0.312	0.125	WAT125-2750-312-E8D	

Dimensions				Designation
D	d	L	t	
in.				-
2.75 cont.	2.5	0.375	0.125	WAT125-2750-375-E8D
	2.5	0.5	0.125	WAT125-2750-500-E8D
	2.5	0.625	0.125	WAT125-2750-625-E8D
	2.5	0.75	0.125	WAT125-2750-750-E8D
	2.5	0.875	0.125	WAT125-2750-875-E8D
	2.5	1	0.125	WAT125-2750-1000-E8D
	2.5	1.25	0.125	WAT125-2750-1250-E8D
	2.5	1.5	0.125	WAT125-2750-1500-E8D
	2.5	1.75	0.125	WAT125-2750-1750-E8D
	2.5	2	0.125	WAT125-2750-2000-E8D
	2.563	0.25	0.093	WAT93-2750-250-E8D
	2.563	0.312	0.093	WAT93-2750-312-E8D
2.563	0.375	0.093	WAT93-2750-375-E8D	
2.563	0.5	0.093	WAT93-2750-500-E8D	
2.563	0.625	0.093	WAT93-2750-625-E8D	
2.563	0.75	0.093	WAT93-2750-750-E8D	
2.563	0.875	0.093	WAT93-2750-875-E8D	
2.563	1	0.093	WAT93-2750-1000-E8D	
2.563	1.25	0.093	WAT93-2750-1250-E8D	
2.563	1.5	0.093	WAT93-2750-1500-E8D	
2.563	1.75	0.093	WAT93-2750-1750-E8D	
2.563	2	0.093	WAT93-2750-2000-E8D	
2.625	0.25	0.062	WAT62-2750-250-E8D	
2.625	0.312	0.062	WAT62-2750-312-E8D	
2.625	0.375	0.062	WAT62-2750-375-E8D	
2.625	0.5	0.062	WAT62-2750-500-E8D	
2.625	0.625	0.062	WAT62-2750-625-E8D	
2.625	0.75	0.062	WAT62-2750-750-E8D	
2.625	0.875	0.062	WAT62-2750-875-E8D	
2.625	1	0.062	WAT62-2750-1000-E8D	
2.625	1.25	0.062	WAT62-2750-1250-E8D	
2.625	1.5	0.062	WAT62-2750-1500-E8D	
2.625	1.75	0.062	WAT62-2750-1750-E8D	
2.625	2	0.062	WAT62-2750-2000-E8D	
3	2.625	0.25	0.187	WAT187-3000-250-E8D
	2.625	0.312	0.187	WAT187-3000-312-E8D
	2.625	0.375	0.187	WAT187-3000-375-E8D
	2.625	0.5	0.187	WAT187-3000-500-E8D
	2.625	0.625	0.187	WAT187-3000-625-E8D
	2.625	0.75	0.187	WAT187-3000-750-E8D
	2.625	0.875	0.187	WAT187-3000-875-E8D
	2.625	1	0.187	WAT187-3000-1000-E8D
	2.625	1.25	0.187	WAT187-3000-1250-E8D
	2.625	1.5	0.187	WAT187-3000-1500-E8D
	2.625	1.75	0.187	WAT187-3000-1750-E8D
	2.625	2	0.187	WAT187-3000-2000-E8D
2.75	0.25	0.125	WAT125-3000-250-E8D	
2.75	0.312	0.125	WAT125-3000-312-E8D	
2.75	0.375	0.125	WAT125-3000-375-E8D	
2.75	0.5	0.125	WAT125-3000-500-E8D	
2.75	0.625	0.125	WAT125-3000-625-E8D	
2.75	0.75	0.125	WAT125-3000-750-E8D	
2.75	0.875	0.125	WAT125-3000-875-E8D	
2.75	1	0.125	WAT125-3000-1000-E8D	
2.75	1.25	0.125	WAT125-3000-1250-E8D	
2.75	1.5	0.125	WAT125-3000-1500-E8D	
2.75	1.75	0.125	WAT125-3000-1750-E8D	
2.75	2	0.125	WAT125-3000-2000-E8D	

5.2 WAT rod or piston guide rings, inch sizes

D 3 – 3.875 in.

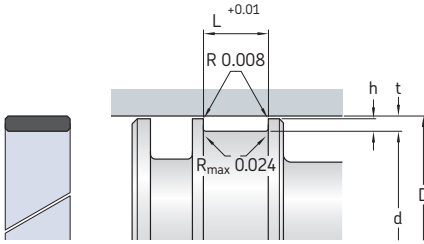

$h \geq t/2$

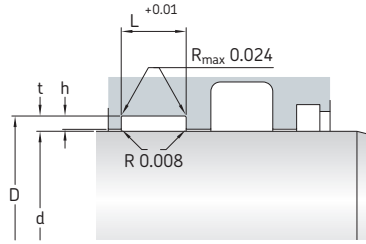

Diameter tolerances			
Cylinder bore D	Tolerances ¹⁾		d
	D	d	
in.	in.		
1 to 4.875	+0.002	-0.002	
5 to 7.75	+0.004	-0.003	
8 to 10.5	+0.006	-0.004	

Piston application
(dynamic on the outside surface)

Diameter tolerances			
Housing groove D	Tolerances ¹⁾		d
	D	d	
in.	in.		
1 to 5.625	+0.002	-0.002	
5.75 to 10.5	+0.003	-0.004	

Rod application
(dynamic on the inside surface)

Dimensions	Designation			
	D	d	L	t
in.	-			
3 cont.	2.813	0.25	0.093	WAT93-3000-250-E8D
	2.813	0.312	0.093	WAT93-3000-312-E8D
	2.813	0.375	0.093	WAT93-3000-375-E8D
	2.813	0.5	0.093	WAT93-3000-500-E8D
	2.813	0.625	0.093	WAT93-3000-625-E8D
	2.813	0.75	0.093	WAT93-3000-750-E8D
	2.813	0.875	0.093	WAT93-3000-875-E8D
	2.813	1	0.093	WAT93-3000-1000-E8D
	2.813	1.25	0.093	WAT93-3000-1250-E8D
	2.813	1.5	0.093	WAT93-3000-1500-E8D
	2.813	1.75	0.093	WAT93-3000-1750-E8D
	2.813	2	0.093	WAT93-3000-2000-E8D
	2.875	0.25	0.062	WAT62-3000-250-E8D
	2.875	0.312	0.062	WAT62-3000-312-E8D
	2.875	0.375	0.062	WAT62-3000-375-E8D
	2.875	0.5	0.062	WAT62-3000-500-E8D
	2.875	0.625	0.062	WAT62-3000-625-E8D
	2.875	0.75	0.062	WAT62-3000-750-E8D
	2.875	0.875	0.062	WAT62-3000-875-E8D
	2.875	1	0.062	WAT62-3000-1000-E8D
2.875	1.25	0.062	WAT62-3000-1250-E8D	
2.875	1.5	0.062	WAT62-3000-1500-E8D	
2.875	1.75	0.062	WAT62-3000-1750-E8D	
2.875	2	0.062	WAT62-3000-2000-E8D	
3.25	2.875	0.25	0.187	WAT187-3250-250-E8D
	2.875	0.312	0.187	WAT187-3250-312-E8D
	2.875	0.375	0.187	WAT187-3250-375-E8D

Dimensions	Designation			
	D	d	L	t
in.	-			
3.25 cont.	2.875	0.5	0.187	WAT187-3250-500-E8D
	2.875	0.625	0.187	WAT187-3250-625-E8D
	2.875	0.75	0.187	WAT187-3250-750-E8D
	2.875	0.875	0.187	WAT187-3250-875-E8D
	2.875	1	0.187	WAT187-3250-1000-E8D
	2.875	1.25	0.187	WAT187-3250-1250-E8D
	2.875	1.5	0.187	WAT187-3250-1500-E8D
	2.875	1.75	0.187	WAT187-3250-1750-E8D
	2.875	2	0.187	WAT187-3250-2000-E8D
	3	0.25	0.125	WAT125-3250-250-E8D
3	0.312	0.125	WAT125-3250-312-E8D	
3	0.375	0.125	WAT125-3250-375-E8D	
3	0.5	0.125	WAT125-3250-500-E8D	
3	0.625	0.125	WAT125-3250-625-E8D	
3	0.75	0.125	WAT125-3250-750-E8D	
3	0.875	0.125	WAT125-3250-875-E8D	
3	1	0.125	WAT125-3250-1000-E8D	
3	1.25	0.125	WAT125-3250-1250-E8D	
3	1.5	0.125	WAT125-3250-1500-E8D	
3	1.75	0.125	WAT125-3250-1750-E8D	
3	2	0.125	WAT125-3250-2000-E8D	
3.063	0.25	0.093	WAT93-3250-250-E8D	
3.063	0.312	0.093	WAT93-3250-312-E8D	
3.063	0.375	0.093	WAT93-3250-375-E8D	
3.063	0.5	0.093	WAT93-3250-500-E8D	
3.063	0.625	0.093	WAT93-3250-625-E8D	
3.063	0.75	0.093	WAT93-3250-750-E8D	

¹⁾ Adjustments according to tolerances provided for rod or piston seals are possible, however, the maximum e-gap also need to be considered (→ Gap extrusion, page 34)

Dimensions				Designation	
D	d	L	t		
in.				-	
3.25 cont.	3.063	0.875	0.093	WAT93-3250-875-E8D	
	3.063	1	0.093	WAT93-3250-1000-E8D	
	3.063	1.25	0.093	WAT93-3250-1250-E8D	
	3.063	1.5	0.093	WAT93-3250-1500-E8D	
	3.063	1.75	0.093	WAT93-3250-1750-E8D	
	3.063	2	0.093	WAT93-3250-2000-E8D	
	3.125	0.25	0.062	WAT62-3250-250-E8D	
	3.125	0.312	0.062	WAT62-3250-312-E8D	
	3.125	0.375	0.062	WAT62-3250-375-E8D	
	3.125	0.5	0.062	WAT62-3250-500-E8D	
	3.125	0.625	0.062	WAT62-3250-625-E8D	
	3.125	0.75	0.062	WAT62-3250-750-E8D	
	3.125	0.875	0.062	WAT62-3250-875-E8D	
	3.125	1	0.062	WAT62-3250-1000-E8D	
	3.125	1.25	0.062	WAT62-3250-1250-E8D	
	3.125	1.5	0.062	WAT62-3250-1500-E8D	
	3.125	1.75	0.062	WAT62-3250-1750-E8D	
	3.125	2	0.062	WAT62-3250-2000-E8D	
	3.5	3.125	0.25	0.187	WAT187-3500-250-E8D
		3.125	0.312	0.187	WAT187-3500-312-E8D
3.125		0.375	0.187	WAT187-3500-375-E8D	
3.125		0.5	0.187	WAT187-3500-500-E8D	
3.125		0.625	0.187	WAT187-3500-625-E8D	
3.125		0.75	0.187	WAT187-3500-750-E8D	
3.125		0.875	0.187	WAT187-3500-875-E8D	
3.125		1	0.187	WAT187-3500-1000-E8D	
3.125		1.25	0.187	WAT187-3500-1250-E8D	
3.125		1.5	0.187	WAT187-3500-1500-E8D	
3.125		1.75	0.187	WAT187-3500-1750-E8D	
3.125		2	0.187	WAT187-3500-2000-E8D	
3.25		0.25	0.125	WAT125-3500-250-E8D	
3.25		0.312	0.125	WAT125-3500-312-E8D	
3.25		0.375	0.125	WAT125-3500-375-E8D	
3.25		0.5	0.125	WAT125-3500-500-E8D	
3.25		0.625	0.125	WAT125-3500-625-E8D	
3.25		0.75	0.125	WAT125-3500-750-E8D	
3.25		0.875	0.125	WAT125-3500-875-E8D	
3.25		1	0.125	WAT125-3500-1000-E8D	
3.25	1.25	0.125	WAT125-3500-1250-E8D		
3.25	1.5	0.125	WAT125-3500-1500-E8D		
3.25	1.75	0.125	WAT125-3500-1750-E8D		
3.25	2	0.125	WAT125-3500-2000-E8D		
3.313	0.25	0.093	WAT93-3500-250-E8D		
3.313	0.312	0.093	WAT93-3500-312-E8D		
3.313	0.375	0.093	WAT93-3500-375-E8D		
3.313	0.5	0.093	WAT93-3500-500-E8D		
3.313	0.625	0.093	WAT93-3500-625-E8D		
3.313	0.75	0.093	WAT93-3500-750-E8D		
3.313	0.875	0.093	WAT93-3500-875-E8D		
3.313	1	0.093	WAT93-3500-1000-E8D		
3.313	1.25	0.093	WAT93-3500-1250-E8D		
3.313	1.5	0.093	WAT93-3500-1500-E8D		
3.313	1.75	0.093	WAT93-3500-1750-E8D		
3.313	2	0.093	WAT93-3500-2000-E8D		
3.375	0.25	0.062	WAT62-3500-250-E8D		
3.375	0.312	0.062	WAT62-3500-312-E8D		
3.375	0.375	0.062	WAT62-3500-375-E8D		

Dimensions				Designation
D	d	L	t	
in.				-
3.5 cont.	3.375	0.5	0.062	WAT62-3500-500-E8D
	3.375	0.625	0.062	WAT62-3500-625-E8D
	3.375	0.75	0.062	WAT62-3500-750-E8D
3.375	0.875	0.062	WAT62-3500-875-E8D	
3.375	1	0.062	WAT62-3500-1000-E8D	
3.375	1.25	0.062	WAT62-3500-1250-E8D	
3.375	1.5	0.062	WAT62-3500-1500-E8D	
3.375	1.75	0.062	WAT62-3500-1750-E8D	
3.375	2	0.062	WAT62-3500-2000-E8D	
3.75	3.375	0.312	0.187	WAT187-3750-312-E8D
	3.375	0.375	0.187	WAT187-3750-375-E8D
	3.375	0.5	0.187	WAT187-3750-500-E8D
	3.375	0.625	0.187	WAT187-3750-625-E8D
	3.375	0.75	0.187	WAT187-3750-750-E8D
	3.375	0.875	0.187	WAT187-3750-875-E8D
	3.375	1	0.187	WAT187-3750-1000-E8D
	3.375	1.25	0.187	WAT187-3750-1250-E8D
	3.375	1.5	0.187	WAT187-3750-1500-E8D
	3.375	1.75	0.187	WAT187-3750-1750-E8D
3.375	2	0.187	WAT187-3750-2000-E8D	
3.5	0.312	0.125	WAT125-3750-312-E8D	
3.5	0.375	0.125	WAT125-3750-375-E8D	
3.5	0.5	0.125	WAT125-3750-500-E8D	
3.5	0.625	0.125	WAT125-3750-625-E8D	
3.5	0.75	0.125	WAT125-3750-750-E8D	
3.5	0.875	0.125	WAT125-3750-875-E8D	
3.5	1	0.125	WAT125-3750-1000-E8D	
3.5	1.25	0.125	WAT125-3750-1250-E8D	
3.5	1.5	0.125	WAT125-3750-1500-E8D	
3.5	1.75	0.125	WAT125-3750-1750-E8D	
3.5	2	0.125	WAT125-3750-2000-E8D	
3.563	0.312	0.093	WAT93-3750-312-E8D	
3.563	0.375	0.093	WAT93-3750-375-E8D	
3.563	0.5	0.093	WAT93-3750-500-E8D	
3.563	0.625	0.093	WAT93-3750-625-E8D	
3.563	0.75	0.093	WAT93-3750-750-E8D	
3.563	0.875	0.093	WAT93-3750-875-E8D	
3.563	1	0.093	WAT93-3750-1000-E8D	
3.563	1.25	0.093	WAT93-3750-1250-E8D	
3.563	1.5	0.093	WAT93-3750-1500-E8D	
3.563	1.75	0.093	WAT93-3750-1750-E8D	
3.563	2	0.093	WAT93-3750-2000-E8D	
3.625	0.312	0.062	WAT62-3750-312-E8D	
3.625	0.375	0.062	WAT62-3750-375-E8D	
3.625	0.5	0.062	WAT62-3750-500-E8D	
3.625	0.625	0.062	WAT62-3750-625-E8D	
3.625	0.75	0.062	WAT62-3750-750-E8D	
3.625	0.875	0.062	WAT62-3750-875-E8D	
3.625	1	0.062	WAT62-3750-1000-E8D	
3.625	1.25	0.062	WAT62-3750-1250-E8D	
3.625	1.5	0.062	WAT62-3750-1500-E8D	
3.625	1.75	0.062	WAT62-3750-1750-E8D	
3.625	2	0.062	WAT62-3750-2000-E8D	
3.875	3.5	0.312	0.187	WAT187-3875-312-E8D
	3.5	0.375	0.187	WAT187-3875-375-E8D
	3.5	0.5	0.187	WAT187-3875-500-E8D

5.2

5.2 WAT rod or piston guide rings, inch sizes

D 3.875 – 4.75 in.

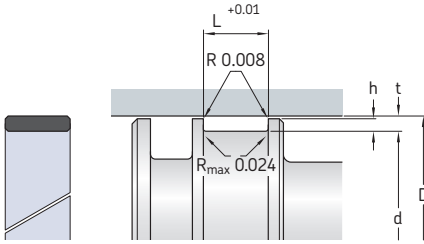

Diameter tolerances

Cylinder bore D	Tolerances ¹⁾	
	D	d
in.	in.	
1 to 4.875	+0.002	-0.002
5 to 7.75	+0.004	-0.003
8 to 10.5	+0.006	-0.004

Piston application
(dynamic on the outside surface)

$h \geq t/2$

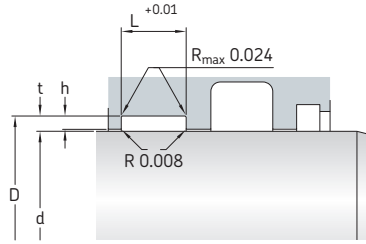

Diameter tolerances

Housing groove D	Tolerances ¹⁾	
	D	d
in.	in.	
1 to 5.625	+0.002	-0.002
5.75 to 10.5	+0.003	-0.004

Rod application
(dynamic on the inside surface)

Dimensions				Designation
D	d	L	t	
in.	-			
3.875	3.5	0.625	0.187	WAT187-3875-625-E8D
cont.	3.5	0.75	0.187	WAT187-3875-750-E8D
	3.5	0.875	0.187	WAT187-3875-875-E8D
	3.5	1	0.187	WAT187-3875-1000-E8D
	3.5	1.25	0.187	WAT187-3875-1250-E8D
	3.5	1.5	0.187	WAT187-3875-1500-E8D
	3.5	1.75	0.187	WAT187-3875-1750-E8D
	3.5	2	0.187	WAT187-3875-2000-E8D
	3.625	0.312	0.125	WAT125-3875-312-E8D
	3.625	0.375	0.125	WAT125-3875-375-E8D
	3.625	0.5	0.125	WAT125-3875-500-E8D
	3.625	0.625	0.125	WAT125-3875-625-E8D
	3.625	0.75	0.125	WAT125-3875-750-E8D
	3.625	0.875	0.125	WAT125-3875-875-E8D
	3.625	1	0.125	WAT125-3875-1000-E8D
	3.625	1.25	0.125	WAT125-3875-1250-E8D
	3.625	1.5	0.125	WAT125-3875-1500-E8D
	3.625	1.75	0.125	WAT125-3875-1750-E8D
	3.625	2	0.125	WAT125-3875-2000-E8D
	3.688	0.312	0.093	WAT93-3875-312-E8D
	3.688	0.375	0.093	WAT93-3875-375-E8D
	3.688	0.5	0.093	WAT93-3875-500-E8D
	3.688	0.625	0.093	WAT93-3875-625-E8D
	3.688	0.75	0.093	WAT93-3875-750-E8D
	3.688	0.875	0.093	WAT93-3875-875-E8D
	3.688	1	0.093	WAT93-3875-1000-E8D

Dimensions				Designation
D	d	L	t	
in.	-			
3.875	3.688	1.25	0.093	WAT93-3875-1250-E8D
cont.	3.688	1.5	0.093	WAT93-3875-1500-E8D
	3.688	1.75	0.093	WAT93-3875-1750-E8D
	3.688	2	0.093	WAT93-3875-2000-E8D
	3.75	0.312	0.062	WAT62-3875-312-E8D
	3.75	0.375	0.062	WAT62-3875-375-E8D
	3.75	0.5	0.062	WAT62-3875-500-E8D
	3.75	0.625	0.062	WAT62-3875-625-E8D
	3.75	0.75	0.062	WAT62-3875-750-E8D
	3.75	0.875	0.062	WAT62-3875-875-E8D
	3.75	1	0.062	WAT62-3875-1000-E8D
	3.75	1.25	0.062	WAT62-3875-1250-E8D
	3.75	1.5	0.062	WAT62-3875-1500-E8D
	3.75	1.75	0.062	WAT62-3875-1750-E8D
	3.75	2	0.062	WAT62-3875-2000-E8D
4	3.625	0.312	0.187	WAT187-4000-312-E8D
	3.625	0.375	0.187	WAT187-4000-375-E8D
	3.625	0.5	0.187	WAT187-4000-500-E8D
	3.625	0.625	0.187	WAT187-4000-625-E8D
	3.625	0.75	0.187	WAT187-4000-750-E8D
	3.625	0.875	0.187	WAT187-4000-875-E8D
	3.625	1	0.187	WAT187-4000-1000-E8D
	3.625	1.25	0.187	WAT187-4000-1250-E8D
	3.625	1.5	0.187	WAT187-4000-1500-E8D
	3.625	1.75	0.187	WAT187-4000-1750-E8D
	3.625	2	0.187	WAT187-4000-2000-E8D

¹⁾ Adjustments according to tolerances provided for rod or piston seals are possible, however, the maximum e-gap also need to be considered (→ *Gap extrusion*, page 34)

Dimensions				Designation
D	d	L	t	
in.				–
4	3.75	0.312	0.125	WAT125-4000-312-E8D
	3.75	0.375	0.125	WAT125-4000-375-E8D
cont.	3.75	0.5	0.125	WAT125-4000-500-E8D
	3.75	0.625	0.125	WAT125-4000-625-E8D
	3.75	0.75	0.125	WAT125-4000-750-E8D
	3.75	0.875	0.125	WAT125-4000-875-E8D
	3.75	1	0.125	WAT125-4000-1000-E8D
	3.75	1.25	0.125	WAT125-4000-1250-E8D
	3.75	1.5	0.125	WAT125-4000-1500-E8D
	3.75	1.75	0.125	WAT125-4000-1750-E8D
	3.75	2	0.125	WAT125-4000-2000-E8D
	3.813	0.312	0.093	WAT93-4000-312-E8D
	3.813	0.375	0.093	WAT93-4000-375-E8D
	3.813	0.5	0.093	WAT93-4000-500-E8D
	3.813	0.625	0.093	WAT93-4000-625-E8D
	3.813	0.75	0.093	WAT93-4000-750-E8D
	3.813	0.875	0.093	WAT93-4000-875-E8D
	3.813	1	0.093	WAT93-4000-1000-E8D
	3.813	1.25	0.093	WAT93-4000-1250-E8D
	3.813	1.5	0.093	WAT93-4000-1500-E8D
	3.813	1.75	0.093	WAT93-4000-1750-E8D
	3.813	2	0.093	WAT93-4000-2000-E8D
4.25	3.875	0.375	0.187	WAT187-4250-375-E8D
	3.875	0.5	0.187	WAT187-4250-500-E8D
	3.875	0.625	0.187	WAT187-4250-625-E8D
	3.875	0.75	0.187	WAT187-4250-750-E8D
	3.875	0.875	0.187	WAT187-4250-875-E8D
	3.875	1	0.187	WAT187-4250-1000-E8D
	3.875	1.25	0.187	WAT187-4250-1250-E8D
	3.875	1.5	0.187	WAT187-4250-1500-E8D
	3.875	1.75	0.187	WAT187-4250-1750-E8D
	3.875	2	0.187	WAT187-4250-2000-E8D
	4	0.375	0.125	WAT125-4250-375-E8D
	4	0.5	0.125	WAT125-4250-500-E8D
	4	0.625	0.125	WAT125-4250-625-E8D
	4	0.75	0.125	WAT125-4250-750-E8D
	4	0.875	0.125	WAT125-4250-875-E8D
	4	1	0.125	WAT125-4250-1000-E8D
	4	1.25	0.125	WAT125-4250-1250-E8D
	4	1.5	0.125	WAT125-4250-1500-E8D
	4	1.75	0.125	WAT125-4250-1750-E8D
	4	2	0.125	WAT125-4250-2000-E8D
	4.063	0.375	0.093	WAT93-4250-375-E8D
	4.063	0.5	0.093	WAT93-4250-500-E8D
	4.063	0.625	0.093	WAT93-4250-625-E8D
	4.063	0.75	0.093	WAT93-4250-750-E8D
	4.063	0.875	0.093	WAT93-4250-875-E8D
	4.063	1	0.093	WAT93-4250-1000-E8D
	4.063	1.25	0.093	WAT93-4250-1250-E8D
	4.063	1.5	0.093	WAT93-4250-1500-E8D
	4.063	1.75	0.093	WAT93-4250-1750-E8D
	4.063	2	0.093	WAT93-4250-2000-E8D
4.5	4.125	0.375	0.187	WAT187-4500-375-E8D
	4.125	0.5	0.187	WAT187-4500-500-E8D
	4.125	0.625	0.187	WAT187-4500-625-E8D
	4.125	0.75	0.187	WAT187-4500-750-E8D
	4.125	0.875	0.187	WAT187-4500-875-E8D

Dimensions				Designation
D	d	L	t	
in.				–
4.5	4.125	1	0.187	WAT187-4500-1000-E8D
	4.125	1.25	0.187	WAT187-4500-1250-E8D
cont.	4.125	1.5	0.187	WAT187-4500-1500-E8D
	4.125	1.75	0.187	WAT187-4500-1750-E8D
	4.125	2	0.187	WAT187-4500-2000-E8D
	4.25	0.375	0.125	WAT125-4500-375-E8D
	4.25	0.5	0.125	WAT125-4500-500-E8D
	4.25	0.625	0.125	WAT125-4500-625-E8D
	4.25	0.75	0.125	WAT125-4500-750-E8D
	4.25	0.875	0.125	WAT125-4500-875-E8D
	4.25	1	0.125	WAT125-4500-1000-E8D
	4.25	1.25	0.125	WAT125-4500-1250-E8D
	4.25	1.5	0.125	WAT125-4500-1500-E8D
	4.25	1.75	0.125	WAT125-4500-1750-E8D
	4.25	2	0.125	WAT125-4500-2000-E8D
	4.313	0.375	0.093	WAT93-4500-375-E8D
	4.313	0.5	0.093	WAT93-4500-500-E8D
	4.313	0.625	0.093	WAT93-4500-625-E8D
	4.313	0.75	0.093	WAT93-4500-750-E8D
	4.313	0.875	0.093	WAT93-4500-875-E8D
	4.313	1	0.093	WAT93-4500-1000-E8D
	4.313	1.25	0.093	WAT93-4500-1250-E8D
	4.313	1.5	0.093	WAT93-4500-1500-E8D
	4.313	1.75	0.093	WAT93-4500-1750-E8D
	4.313	2	0.093	WAT93-4500-2000-E8D
4.75	4.375	0.375	0.187	WAT187-4750-375-E8D
	4.375	0.5	0.187	WAT187-4750-500-E8D
	4.375	0.625	0.187	WAT187-4750-625-E8D
	4.375	0.75	0.187	WAT187-4750-750-E8D
	4.375	0.875	0.187	WAT187-4750-875-E8D
	4.375	1	0.187	WAT187-4750-1000-E8D
	4.375	1.25	0.187	WAT187-4750-1250-E8D
	4.375	1.5	0.187	WAT187-4750-1500-E8D
	4.375	1.75	0.187	WAT187-4750-1750-E8D
	4.375	2	0.187	WAT187-4750-2000-E8D
	4.5	0.375	0.125	WAT125-4750-375-E8D
	4.5	0.5	0.125	WAT125-4750-500-E8D
	4.5	0.625	0.125	WAT125-4750-625-E8D
	4.5	0.75	0.125	WAT125-4750-750-E8D
	4.5	0.875	0.125	WAT125-4750-875-E8D
	4.5	1	0.125	WAT125-4750-1000-E8D
	4.5	1.25	0.125	WAT125-4750-1250-E8D
	4.5	1.5	0.125	WAT125-4750-1500-E8D
	4.5	1.75	0.125	WAT125-4750-1750-E8D
	4.5	2	0.125	WAT125-4750-2000-E8D
	4.563	0.375	0.093	WAT93-4750-375-E8D
	4.563	0.5	0.093	WAT93-4750-500-E8D
	4.563	0.625	0.093	WAT93-4750-625-E8D
	4.563	0.75	0.093	WAT93-4750-750-E8D
	4.563	0.875	0.093	WAT93-4750-875-E8D
	4.563	1	0.093	WAT93-4750-1000-E8D
	4.563	1.25	0.093	WAT93-4750-1250-E8D
	4.563	1.5	0.093	WAT93-4750-1500-E8D
	4.563	1.75	0.093	WAT93-4750-1750-E8D
	4.563	2	0.093	WAT93-4750-2000-E8D

5.2 WAT rod or piston guide rings, inch sizes

D 4.875 – 5.75 in.

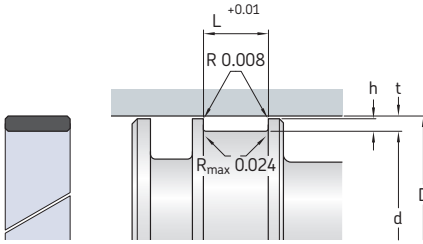

Diameter tolerances			
Cylinder bore D	Tolerances ¹⁾		d
	D		
in.	in.		
1 to 4.875	+0.002	-0.002	
5 to 7.75	+0.004	-0.003	
8 to 10.5	+0.006	-0.004	

Piston application
(dynamic on the outside surface)

$h \geq t/2$

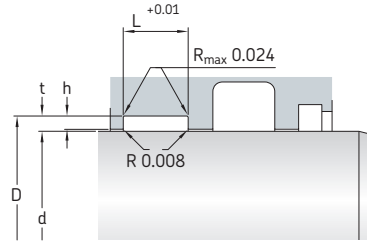

Diameter tolerances			
Housing groove D	Tolerances ¹⁾		d
	D		
in.	in.		
1 to 5.625	+0.002	-0.002	
5.75 to 10.5	+0.003	-0.004	

Rod application
(dynamic on the inside surface)

Dimensions				Designation	
D	d	L	t		
in.				-	
4.875	4.5	0.375	0.187	WAT187-4875-375-E8D	
	4.5	0.5	0.187	WAT187-4875-500-E8D	
	4.5	0.625	0.187	WAT187-4875-625-E8D	
	4.5	0.75	0.187	WAT187-4875-750-E8D	
	4.5	0.875	0.187	WAT187-4875-875-E8D	
	4.5	1	0.187	WAT187-4875-1000-E8D	
	4.5	1.25	0.187	WAT187-4875-1250-E8D	
	4.5	1.5	0.187	WAT187-4875-1500-E8D	
	4.5	1.75	0.187	WAT187-4875-1750-E8D	
	4.5	2	0.187	WAT187-4875-2000-E8D	
	4.625	0.375	0.125	WAT125-4875-375-E8D	
	4.625	0.5	0.125	WAT125-4875-500-E8D	
4.625	0.625	0.125	WAT125-4875-625-E8D		
4.625	0.75	0.125	WAT125-4875-750-E8D		
4.625	0.875	0.125	WAT125-4875-875-E8D		
4.625	1	0.125	WAT125-4875-1000-E8D		
4.625	1.25	0.125	WAT125-4875-1250-E8D		
4.625	1.5	0.125	WAT125-4875-1500-E8D		
4.625	1.75	0.125	WAT125-4875-1750-E8D		
4.625	2	0.125	WAT125-4875-2000-E8D		
4.688	0.375	0.093	WAT93-4875-375-E8D		
4.688	0.5	0.093	WAT93-4875-500-E8D		
4.688	0.625	0.093	WAT93-4875-625-E8D		
4.688	0.75	0.093	WAT93-4875-750-E8D		
4.688	0.875	0.093	WAT93-4875-875-E8D		
4.688	1	0.093	WAT93-4875-1000-E8D		
4.688	1.25	0.093	WAT93-4875-1250-E8D		

Dimensions				Designation	
D	d	L	t		
in.				-	
4.875	4.688	1.5	0.093	WAT93-4875-1500-E8D	
	4.688	1.75	0.093	WAT93-4875-1750-E8D	
	4.688	2	0.093	WAT93-4875-2000-E8D	
5	4.625	0.375	0.187	WAT187-5000-375-E8D	
	4.625	0.5	0.187	WAT187-5000-500-E8D	
	4.625	0.625	0.187	WAT187-5000-625-E8D	
	4.625	0.75	0.187	WAT187-5000-750-E8D	
	4.625	0.875	0.187	WAT187-5000-875-E8D	
	4.625	1	0.187	WAT187-5000-1000-E8D	
	4.625	1.25	0.187	WAT187-5000-1250-E8D	
	4.625	1.5	0.187	WAT187-5000-1500-E8D	
	4.625	1.75	0.187	WAT187-5000-1750-E8D	
	4.625	2	0.187	WAT187-5000-2000-E8D	
	4.75	0.375	0.125	WAT125-5000-375-E8D	
	4.75	0.5	0.125	WAT125-5000-500-E8D	
4.75	0.625	0.125	WAT125-5000-625-E8D		
4.75	0.75	0.125	WAT125-5000-750-E8D		
4.75	0.875	0.125	WAT125-5000-875-E8D		
4.75	1	0.125	WAT125-5000-1000-E8D		
4.75	1.25	0.125	WAT125-5000-1250-E8D		
4.75	1.5	0.125	WAT125-5000-1500-E8D		
4.75	1.75	0.125	WAT125-5000-1750-E8D		
4.75	2	0.125	WAT125-5000-2000-E8D		
4.813	0.375	0.093	WAT93-5000-375-E8D		
4.813	0.5	0.093	WAT93-5000-500-E8D		
4.813	0.625	0.093	WAT93-5000-625-E8D		
4.813	0.75	0.093	WAT93-5000-750-E8D		

¹⁾ Adjustments according to tolerances provided for rod or piston seals are possible, however, the maximum e-gap also need to be considered (→ Gap extrusion, page 34)

Dimensions				Designation
D	d	L	t	
in.				-
5	4.813	0.875	0.093	WAT93-5000-875-E8D
cont.	4.813	1	0.093	WAT93-5000-1000-E8D
	4.813	1.25	0.093	WAT93-5000-1250-E8D
	4.813	1.5	0.093	WAT93-5000-1500-E8D
	4.813	1.75	0.093	WAT93-5000-1750-E8D
	4.813	2	0.093	WAT93-5000-2000-E8D
5.25	4.875	0.375	0.187	WAT187-5250-375-E8D
	4.875	0.5	0.187	WAT187-5250-500-E8D
	4.875	0.625	0.187	WAT187-5250-625-E8D
	4.875	0.75	0.187	WAT187-5250-750-E8D
	4.875	0.875	0.187	WAT187-5250-875-E8D
	4.875	1	0.187	WAT187-5250-1000-E8D
	4.875	1.25	0.187	WAT187-5250-1250-E8D
	4.875	1.5	0.187	WAT187-5250-1500-E8D
	4.875	1.75	0.187	WAT187-5250-1750-E8D
	4.875	2	0.187	WAT187-5250-2000-E8D
	4.875	2.25	0.187	WAT187-5250-2250-E8D
	4.875	2.5	0.187	WAT187-5250-2500-E8D
5	0.375	0.125		WAT125-5250-375-E8D
5	0.5	0.125		WAT125-5250-500-E8D
5	0.625	0.125		WAT125-5250-625-E8D
5	0.75	0.125		WAT125-5250-750-E8D
5	0.875	0.125		WAT125-5250-875-E8D
5	1	0.125		WAT125-5250-1000-E8D
5	1.25	0.125		WAT125-5250-1250-E8D
5	1.5	0.125		WAT125-5250-1500-E8D
5	1.75	0.125		WAT125-5250-1750-E8D
5	2	0.125		WAT125-5250-2000-E8D
5	2.25	0.125		WAT125-5250-2250-E8D
5	2.5	0.125		WAT125-5250-2500-E8D
5.063	0.375	0.093		WAT93-5250-375-E8D
5.063	0.5	0.093		WAT93-5250-500-E8D
5.063	0.625	0.093		WAT93-5250-625-E8D
5.063	0.75	0.093		WAT93-5250-750-E8D
5.063	0.875	0.093		WAT93-5250-875-E8D
5.063	1	0.093		WAT93-5250-1000-E8D
5.063	1.25	0.093		WAT93-5250-1250-E8D
5.063	1.5	0.093		WAT93-5250-1500-E8D
5.063	1.75	0.093		WAT93-5250-1750-E8D
5.063	2	0.093		WAT93-5250-2000-E8D
5.063	2.25	0.093		WAT93-5250-2250-E8D
5.063	2.5	0.093		WAT93-5250-2500-E8D
5.5	5.125	0.375	0.187	WAT187-5500-375-E8D
	5.125	0.5	0.187	WAT187-5500-500-E8D
	5.125	0.625	0.187	WAT187-5500-625-E8D
	5.125	0.75	0.187	WAT187-5500-750-E8D
	5.125	0.875	0.187	WAT187-5500-875-E8D
	5.125	1	0.187	WAT187-5500-1000-E8D
	5.125	1.25	0.187	WAT187-5500-1250-E8D
	5.125	1.5	0.187	WAT187-5500-1500-E8D
	5.125	1.75	0.187	WAT187-5500-1750-E8D
	5.125	2	0.187	WAT187-5500-2000-E8D
	5.25	0.375	0.125	WAT125-5500-375-E8D
	5.25	0.5	0.125	WAT125-5500-500-E8D
	5.25	0.625	0.125	WAT125-5500-625-E8D
	5.25	0.75	0.125	WAT125-5500-750-E8D
	5.25	0.875	0.125	WAT125-5500-875-E8D

Dimensions				Designation
D	d	L	t	
in.				-
5.5	5.25	1	0.125	WAT125-5500-1000-E8D
cont.	5.25	1.25	0.125	WAT125-5500-1250-E8D
	5.25	1.5	0.125	WAT125-5500-1500-E8D
	5.25	1.75	0.125	WAT125-5500-1750-E8D
	5.25	2	0.125	WAT125-5500-2000-E8D
	5.313	0.375	0.093	WAT93-5500-375-E8D
	5.313	0.5	0.093	WAT93-5500-500-E8D
	5.313	0.625	0.093	WAT93-5500-625-E8D
	5.313	0.75	0.093	WAT93-5500-750-E8D
	5.313	0.875	0.093	WAT93-5500-875-E8D
	5.313	1	0.093	WAT93-5500-1000-E8D
	5.313	1.25	0.093	WAT93-5500-1250-E8D
	5.313	1.5	0.093	WAT93-5500-1500-E8D
	5.313	1.75	0.093	WAT93-5500-1750-E8D
	5.313	2	0.093	WAT93-5500-2000-E8D
5.625	5.25	0.375	0.187	WAT187-5625-375-E8D
	5.25	0.5	0.187	WAT187-5625-500-E8D
	5.25	0.625	0.187	WAT187-5625-625-E8D
	5.25	0.75	0.187	WAT187-5625-750-E8D
	5.25	0.875	0.187	WAT187-5625-875-E8D
	5.25	1	0.187	WAT187-5625-1000-E8D
	5.25	1.25	0.187	WAT187-5625-1250-E8D
	5.25	1.5	0.187	WAT187-5625-1500-E8D
	5.25	1.75	0.187	WAT187-5625-1750-E8D
	5.25	2	0.187	WAT187-5625-2000-E8D
	5.375	0.375	0.125	WAT125-5625-375-E8D
	5.375	0.5	0.125	WAT125-5625-500-E8D
	5.375	0.625	0.125	WAT125-5625-625-E8D
	5.375	0.75	0.125	WAT125-5625-750-E8D
	5.375	0.875	0.125	WAT125-5625-875-E8D
	5.375	1	0.125	WAT125-5625-1000-E8D
	5.375	1.25	0.125	WAT125-5625-1250-E8D
	5.375	1.5	0.125	WAT125-5625-1500-E8D
	5.375	1.75	0.125	WAT125-5625-1750-E8D
	5.375	2	0.125	WAT125-5625-2000-E8D
	5.438	0.375	0.093	WAT93-5625-375-E8D
	5.438	0.5	0.093	WAT93-5625-500-E8D
	5.438	0.625	0.093	WAT93-5625-625-E8D
	5.438	0.75	0.093	WAT93-5625-750-E8D
	5.438	0.875	0.093	WAT93-5625-875-E8D
	5.438	1	0.093	WAT93-5625-1000-E8D
	5.438	1.25	0.093	WAT93-5625-1250-E8D
	5.438	1.5	0.093	WAT93-5625-1500-E8D
	5.438	1.75	0.093	WAT93-5625-1750-E8D
	5.438	2	0.093	WAT93-5625-2000-E8D
5.75	5.375	0.375	0.187	WAT187-5750-375-E8D
	5.375	0.5	0.187	WAT187-5750-500-E8D
	5.375	0.625	0.187	WAT187-5750-625-E8D
	5.375	0.75	0.187	WAT187-5750-750-E8D
	5.375	0.875	0.187	WAT187-5750-875-E8D
	5.375	1	0.187	WAT187-5750-1000-E8D
	5.375	1.25	0.187	WAT187-5750-1250-E8D
	5.375	1.5	0.187	WAT187-5750-1500-E8D
	5.375	1.75	0.187	WAT187-5750-1750-E8D
	5.375	2	0.187	WAT187-5750-2000-E8D

5.2

5.2 WAT rod or piston guide rings, inch sizes

D 5.75 – 7.75 in.

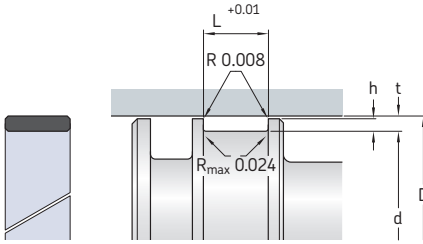

Diameter tolerances			
Cylinder bore		Tolerances ¹⁾	
D		D	d
in.		in.	
1 to 4.875		+0.002	-0.002
5 to 7.75		+0.004	-0.003
8 to 10.5		+0.006	-0.004

Piston application
(dynamic on the outside surface)

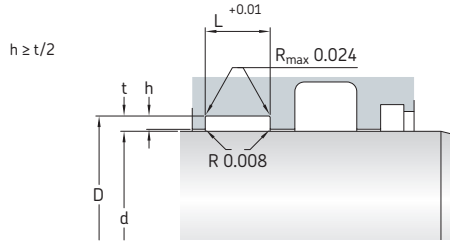

Diameter tolerances			
Housing groove		Tolerances ¹⁾	
D		D	d
in.		in.	
1 to 5.625		+0.002	-0.002
5.75 to 10.5		+0.003	-0.004

Rod application
(dynamic on the inside surface)

Dimensions					Designation
D	d	L	t		
in.					-
5.75 cont.	5.5	0.375	0.125		WAT125-5750-375-E8D
	5.5	0.5	0.125		WAT125-5750-500-E8D
	5.5	0.625	0.125		WAT125-5750-625-E8D
	5.5	0.75	0.125		WAT125-5750-750-E8D
	5.5	0.875	0.125		WAT125-5750-875-E8D
	5.5	1	0.125		WAT125-5750-1000-E8D
	5.5	1.25	0.125		WAT125-5750-1250-E8D
	5.5	1.5	0.125		WAT125-5750-1500-E8D
	5.5	1.75	0.125		WAT125-5750-1750-E8D
	5.5	2	0.125		WAT125-5750-2000-E8D
	5.563	0.375	0.093		WAT93-5750-375-E8D
	5.563	0.5	0.093		WAT93-5750-500-E8D
5.563	0.625	0.093		WAT93-5750-625-E8D	
5.563	0.75	0.093		WAT93-5750-750-E8D	
5.563	0.875	0.093		WAT93-5750-875-E8D	
5.563	1	0.093		WAT93-5750-1000-E8D	
5.563	1.25	0.093		WAT93-5750-1250-E8D	
5.563	1.5	0.093		WAT93-5750-1500-E8D	
5.563	1.75	0.093		WAT93-5750-1750-E8D	
5.563	2	0.093		WAT93-5750-2000-E8D	
6	5.625	0.375	0.187		WAT187-6000-375-E8D
	5.625	0.5	0.187		WAT187-6000-500-E8D
	5.625	0.625	0.187		WAT187-6000-625-E8D
	5.625	0.75	0.187		WAT187-6000-750-E8D
	5.625	0.875	0.187		WAT187-6000-875-E8D
	5.625	1	0.187		WAT187-6000-1000-E8D
	5.625	1.25	0.187		WAT187-6000-1250-E8D

Dimensions					Designation	
D	d	L	t			
in.					-	
6 cont.	5.625	1.5	0.187		WAT187-6000-1500-E8D	
	5.625	1.75	0.187		WAT187-6000-1750-E8D	
	5.625	2	0.187		WAT187-6000-2000-E8D	
6	5.75	0.375	0.125		WAT125-6000-375-E8D	
	5.75	0.5	0.125		WAT125-6000-500-E8D	
	5.75	0.625	0.125		WAT125-6000-625-E8D	
	5.75	0.75	0.125		WAT125-6000-750-E8D	
	5.75	0.875	0.125		WAT125-6000-875-E8D	
	5.75	1	0.125		WAT125-6000-1000-E8D	
	5.75	1.25	0.125		WAT125-6000-1250-E8D	
	5.75	1.5	0.125		WAT125-6000-1500-E8D	
	5.75	1.75	0.125		WAT125-6000-1750-E8D	
	5.75	2	0.125		WAT125-6000-2000-E8D	
	6.25	5.875	0.5	0.187		WAT187-6250-500-E8D
		5.875	0.625	0.187		WAT187-6250-625-E8D
5.875		0.75	0.187		WAT187-6250-750-E8D	
5.875		0.875	0.187		WAT187-6250-875-E8D	
5.875		1	0.187		WAT187-6250-1000-E8D	
5.875		1.25	0.187		WAT187-6250-1250-E8D	
5.875		1.5	0.187		WAT187-6250-1500-E8D	
5.875		1.75	0.187		WAT187-6250-1750-E8D	
5.875		2	0.187		WAT187-6250-2000-E8D	
6		0.5	0.125		WAT125-6250-500-E8D	
6		0.625	0.125		WAT125-6250-625-E8D	
6		0.75	0.125		WAT125-6250-750-E8D	
6	0.875	0.125		WAT125-6250-875-E8D		

¹⁾ Adjustments according to tolerances provided for rod or piston seals are possible, however, the maximum e-gap also need to be considered (→ Gap extrusion, page 34)

Dimensions				Designation
D	d	L	t	
in.				-
6.25 cont.	6	1	0.125	WAT125-6250-1000-E8D
	6	1.25	0.125	WAT125-6250-1250-E8D
	6	1.5	0.125	WAT125-6250-1500-E8D
	6	1.75	0.125	WAT125-6250-1750-E8D
	6	2	0.125	WAT125-6250-2000-E8D
6.5	6.125	0.5	0.187	WAT187-6500-500-E8D
	6.125	0.625	0.187	WAT187-6500-625-E8D
	6.125	0.75	0.187	WAT187-6500-750-E8D
	6.125	0.875	0.187	WAT187-6500-875-E8D
	6.125	1	0.187	WAT187-6500-1000-E8D
	6.125	1.25	0.187	WAT187-6500-1250-E8D
	6.125	1.5	0.187	WAT187-6500-1500-E8D
	6.125	1.75	0.187	WAT187-6500-1750-E8D
	6.125	2	0.187	WAT187-6500-2000-E8D
	6.25	0.5	0.125	WAT125-6500-500-E8D
	6.25	0.625	0.125	WAT125-6500-625-E8D
	6.25	0.75	0.125	WAT125-6500-750-E8D
	6.25	0.875	0.125	WAT125-6500-875-E8D
	6.25	1	0.125	WAT125-6500-1000-E8D
	6.25	1.25	0.125	WAT125-6500-1250-E8D
6.25	1.5	0.125	WAT125-6500-1500-E8D	
6.25	1.75	0.125	WAT125-6500-1750-E8D	
6.25	2	0.125	WAT125-6500-2000-E8D	
6.75	6.375	0.5	0.187	WAT187-6750-500-E8D
	6.375	0.625	0.187	WAT187-6750-625-E8D
	6.375	0.75	0.187	WAT187-6750-750-E8D
	6.375	0.875	0.187	WAT187-6750-875-E8D
	6.375	1	0.187	WAT187-6750-1000-E8D
	6.375	1.25	0.187	WAT187-6750-1250-E8D
	6.375	1.5	0.187	WAT187-6750-1500-E8D
	6.375	1.75	0.187	WAT187-6750-1750-E8D
	6.375	2	0.187	WAT187-6750-2000-E8D
	6.5	0.5	0.125	WAT125-6750-500-E8D
	6.5	0.625	0.125	WAT125-6750-625-E8D
	6.5	0.75	0.125	WAT125-6750-750-E8D
	6.5	0.875	0.125	WAT125-6750-875-E8D
	6.5	1	0.125	WAT125-6750-1000-E8D
	6.5	1.25	0.125	WAT125-6750-1250-E8D
6.5	1.5	0.125	WAT125-6750-1500-E8D	
6.5	1.75	0.125	WAT125-6750-1750-E8D	
6.5	2	0.125	WAT125-6750-2000-E8D	
7	6.625	0.5	0.187	WAT187-7000-500-E8D
	6.625	0.625	0.187	WAT187-7000-625-E8D
	6.625	0.75	0.187	WAT187-7000-750-E8D
	6.625	0.875	0.187	WAT187-7000-875-E8D
	6.625	1	0.187	WAT187-7000-1000-E8D
	6.625	1.25	0.187	WAT187-7000-1250-E8D
	6.625	1.5	0.187	WAT187-7000-1500-E8D
	6.625	1.75	0.187	WAT187-7000-1750-E8D
	6.625	2	0.187	WAT187-7000-2000-E8D
	6.75	0.5	0.125	WAT125-7000-500-E8D
	6.75	0.625	0.125	WAT125-7000-625-E8D
	6.75	0.75	0.125	WAT125-7000-750-E8D
	6.75	0.875	0.125	WAT125-7000-875-E8D
	6.75	1	0.125	WAT125-7000-1000-E8D
	6.75	1.25	0.125	WAT125-7000-1250-E8D

Dimensions				Designation
D	d	L	t	
in.				-
7 cont.	6.75	1.5	0.125	WAT125-7000-1500-E8D
	6.75	1.75	0.125	WAT125-7000-1750-E8D
	6.75	2	0.125	WAT125-7000-2000-E8D
7.25	6.875	0.5	0.187	WAT187-7250-500-E8D
	6.875	0.625	0.187	WAT187-7250-625-E8D
	6.875	0.75	0.187	WAT187-7250-750-E8D
	6.875	0.875	0.187	WAT187-7250-875-E8D
	6.875	1	0.187	WAT187-7250-1000-E8D
6.875	1.25	0.187	WAT187-7250-1250-E8D	
6.875	1.5	0.187	WAT187-7250-1500-E8D	
6.875	1.75	0.187	WAT187-7250-1750-E8D	
6.875	2	0.187	WAT187-7250-2000-E8D	
7	0.5	0.125	WAT125-7250-500-E8D	
7	0.625	0.125	WAT125-7250-625-E8D	
7	0.75	0.125	WAT125-7250-750-E8D	
7	0.875	0.125	WAT125-7250-875-E8D	
7	1	0.125	WAT125-7250-1000-E8D	
7	1.25	0.125	WAT125-7250-1250-E8D	
7	1.5	0.125	WAT125-7250-1500-E8D	
7	1.75	0.125	WAT125-7250-1750-E8D	
7	2	0.125	WAT125-7250-2000-E8D	
7.5	7.125	0.5	0.187	WAT187-7500-500-E8D
	7.125	0.625	0.187	WAT187-7500-625-E8D
	7.125	0.75	0.187	WAT187-7500-750-E8D
	7.125	0.875	0.187	WAT187-7500-875-E8D
	7.125	1	0.187	WAT187-7500-1000-E8D
7.125	1.25	0.187	WAT187-7500-1250-E8D	
7.125	1.5	0.187	WAT187-7500-1500-E8D	
7.125	1.75	0.187	WAT187-7500-1750-E8D	
7.125	2	0.187	WAT187-7500-2000-E8D	
7.25	0.5	0.125	WAT125-7500-500-E8D	
7.25	0.625	0.125	WAT125-7500-625-E8D	
7.25	0.75	0.125	WAT125-7500-750-E8D	
7.25	0.875	0.125	WAT125-7500-875-E8D	
7.25	1	0.125	WAT125-7500-1000-E8D	
7.25	1.25	0.125	WAT125-7500-1250-E8D	
7.25	1.5	0.125	WAT125-7500-1500-E8D	
7.25	1.75	0.125	WAT125-7500-1750-E8D	
7.25	2	0.125	WAT125-7500-2000-E8D	
7.75	7.375	0.625	0.187	WAT187-7750-625-E8D
	7.375	0.75	0.187	WAT187-7750-750-E8D
	7.375	0.875	0.187	WAT187-7750-875-E8D
	7.375	1	0.187	WAT187-7750-1000-E8D
	7.375	1.25	0.187	WAT187-7750-1250-E8D
7.375	1.5	0.187	WAT187-7750-1500-E8D	
7.375	1.75	0.187	WAT187-7750-1750-E8D	
7.375	2	0.187	WAT187-7750-2000-E8D	
7.5	0.625	0.125	WAT125-7750-625-E8D	
7.5	0.75	0.125	WAT125-7750-750-E8D	
7.5	0.875	0.125	WAT125-7750-875-E8D	
7.5	1	0.125	WAT125-7750-1000-E8D	
7.5	1.25	0.125	WAT125-7750-1250-E8D	
7.5	1.5	0.125	WAT125-7750-1500-E8D	
7.5	1.75	0.125	WAT125-7750-1750-E8D	
7.5	2	0.125	WAT125-7750-2000-E8D	

5.2

5.2 WAT rod or piston guide rings, inch sizes

D 8 – 10.5 in.

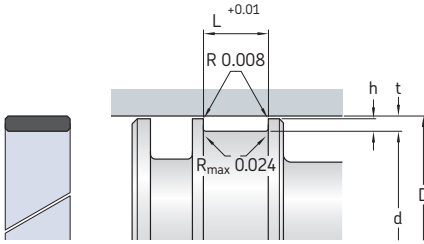

Diameter tolerances		
Cylinder bore	Tolerances ¹⁾	
D	D	d
in.	in.	
1 to 4.875	+0.002	-0.002
5 to 7.75	+0.004	-0.003
8 to 10.5	+0.006	-0.004

Piston application
(dynamic on the outside surface)

$h \geq t/2$

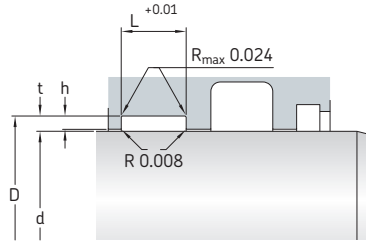

Diameter tolerances		
Housing groove	Tolerances ¹⁾	
D	D	d
in.	in.	
1 to 5.625	+0.002	-0.002
5.75 to 10.5	+0.003	-0.004

Rod application
(dynamic on the inside surface)

Dimensions				Designation
D	d	L	t	
in.				-
8	7.625	0.625	0.187	WAT187-8000-625-E8D
	7.625	0.75	0.187	WAT187-8000-750-E8D
	7.625	0.875	0.187	WAT187-8000-875-E8D
	7.625	1	0.187	WAT187-8000-1000-E8D
	7.625	1.25	0.187	WAT187-8000-1250-E8D
	7.625	1.5	0.187	WAT187-8000-1500-E8D
	7.625	1.75	0.187	WAT187-8000-1750-E8D
	7.625	2	0.187	WAT187-8000-2000-E8D
	7.75	0.625	0.125	WAT125-8000-625-E8D
	7.75	0.75	0.125	WAT125-8000-750-E8D
	7.75	0.875	0.125	WAT125-8000-875-E8D
	7.75	1	0.125	WAT125-8000-1000-E8D
8.25	7.875	0.625	0.187	WAT187-8250-625-E8D
	7.875	0.75	0.187	WAT187-8250-750-E8D
	7.875	0.875	0.187	WAT187-8250-875-E8D
	7.875	1	0.187	WAT187-8250-1000-E8D
	7.875	1.25	0.187	WAT187-8250-1250-E8D
	7.875	1.5	0.187	WAT187-8250-1500-E8D
	7.875	1.75	0.187	WAT187-8250-1750-E8D
	7.875	2	0.187	WAT187-8250-2000-E8D

Dimensions				Designation	
D	d	L	t		
in.				-	
8.25	8	0.625	0.125	WAT125-8250-625-E8D	
	8	0.75	0.125	WAT125-8250-750-E8D	
	8	0.875	0.125	WAT125-8250-875-E8D	
	8	1	0.125	WAT125-8250-1000-E8D	
	8	1.25	0.125	WAT125-8250-1250-E8D	
	8	1.5	0.125	WAT125-8250-1500-E8D	
	8	1.75	0.125	WAT125-8250-1750-E8D	
	8	2	0.125	WAT125-8250-2000-E8D	
	8.5	8.125	0.625	0.187	WAT187-8500-625-E8D
		8.125	0.75	0.187	WAT187-8500-750-E8D
		8.125	0.875	0.187	WAT187-8500-875-E8D
		8.125	1	0.187	WAT187-8500-1000-E8D
8.125		1.25	0.187	WAT187-8500-1250-E8D	
8.125		1.5	0.187	WAT187-8500-1500-E8D	
8.125		1.75	0.187	WAT187-8500-1750-E8D	
8.125		2	0.187	WAT187-8500-2000-E8D	
8.25		8.25	0.625	0.125	WAT125-8500-625-E8D
		8.25	0.75	0.125	WAT125-8500-750-E8D
		8.25	0.875	0.125	WAT125-8500-875-E8D
		8.25	1	0.125	WAT125-8500-1000-E8D
	8.25	1.25	0.125	WAT125-8500-1250-E8D	
	8.25	1.5	0.125	WAT125-8500-1500-E8D	
	8.25	1.75	0.125	WAT125-8500-1750-E8D	
	8.25	2	0.125	WAT125-8500-2000-E8D	

¹⁾ Adjustments according to tolerances provided for rod or piston seals are possible, however, the maximum e-gap also need to be considered (→ Gap extrusion, page 34)

Dimensions				Designation
D	d	L	t	
in.				-
8.75	8.375	0.625	0.187	WAT187-8750-625-E8D
	8.375	0.75	0.187	WAT187-8750-750-E8D
	8.375	0.875	0.187	WAT187-8750-875-E8D
	8.375	1	0.187	WAT187-8750-1000-E8D
	8.375	1.25	0.187	WAT187-8750-1250-E8D
	8.375	1.5	0.187	WAT187-8750-1500-E8D
	8.375	1.75	0.187	WAT187-8750-1750-E8D
	8.375	2	0.187	WAT187-8750-2000-E8D
	8.5	0.625	0.125	WAT125-8750-625-E8D
	8.5	0.75	0.125	WAT125-8750-750-E8D
	8.5	0.875	0.125	WAT125-8750-875-E8D
	8.5	1	0.125	WAT125-8750-1000-E8D
8.5	1.25	0.125	WAT125-8750-1250-E8D	
8.5	1.5	0.125	WAT125-8750-1500-E8D	
8.5	1.75	0.125	WAT125-8750-1750-E8D	
8.5	2	0.125	WAT125-8750-2000-E8D	
9	8.625	0.625	0.187	WAT187-9000-625-E8D
	8.625	0.75	0.187	WAT187-9000-750-E8D
	8.625	0.875	0.187	WAT187-9000-875-E8D
	8.625	1	0.187	WAT187-9000-1000-E8D
	8.625	1.25	0.187	WAT187-9000-1250-E8D
	8.625	1.5	0.187	WAT187-9000-1500-E8D
	8.625	1.75	0.187	WAT187-9000-1750-E8D
	8.625	2	0.187	WAT187-9000-2000-E8D
	8.75	0.625	0.125	WAT125-9000-625-E8D
	8.75	0.75	0.125	WAT125-9000-750-E8D
	8.75	0.875	0.125	WAT125-9000-875-E8D
	8.75	1	0.125	WAT125-9000-1000-E8D
8.75	1.25	0.125	WAT125-9000-1250-E8D	
8.75	1.5	0.125	WAT125-9000-1500-E8D	
8.75	1.75	0.125	WAT125-9000-1750-E8D	
8.75	2	0.125	WAT125-9000-2000-E8D	
9.25	8.875	0.75	0.187	WAT187-9250-750-E8D
	8.875	0.875	0.187	WAT187-9250-875-E8D
	8.875	1	0.187	WAT187-9250-1000-E8D
	8.875	1.25	0.187	WAT187-9250-1250-E8D
	8.875	1.5	0.187	WAT187-9250-1500-E8D
	8.875	1.75	0.187	WAT187-9250-1750-E8D
	8.875	2	0.187	WAT187-9250-2000-E8D
	9	0.75	0.125	WAT125-9250-750-E8D
	9	0.875	0.125	WAT125-9250-875-E8D
	9	1	0.125	WAT125-9250-1000-E8D
	9	1.25	0.125	WAT125-9250-1250-E8D
	9	1.5	0.125	WAT125-9250-1500-E8D
9	1.75	0.125	WAT125-9250-1750-E8D	
9	2	0.125	WAT125-9250-2000-E8D	
9.5	9.125	0.75	0.187	WAT187-9500-750-E8D
	9.125	0.875	0.187	WAT187-9500-875-E8D
	9.125	1	0.187	WAT187-9500-1000-E8D
	9.125	1.25	0.187	WAT187-9500-1250-E8D
	9.125	1.5	0.187	WAT187-9500-1500-E8D
	9.125	1.75	0.187	WAT187-9500-1750-E8D
	9.125	2	0.187	WAT187-9500-2000-E8D

Dimensions				Designation
D	d	L	t	
in.				-
9.5	9.25	0.75	0.125	WAT125-9500-750-E8D
	9.25	0.875	0.125	WAT125-9500-875-E8D
	9.25	1	0.125	WAT125-9500-1000-E8D
	9.25	1.25	0.125	WAT125-9500-1250-E8D
	9.25	1.5	0.125	WAT125-9500-1500-E8D
	9.25	1.75	0.125	WAT125-9500-1750-E8D
	9.25	2	0.125	WAT125-9500-2000-E8D
	9.75	0.75	0.187	WAT187-9750-750-E8D
	9.375	0.875	0.187	WAT187-9750-875-E8D
	9.375	1	0.187	WAT187-9750-1000-E8D
	9.375	1.25	0.187	WAT187-9750-1250-E8D
	9.375	1.5	0.187	WAT187-9750-1500-E8D
9.375	1.75	0.187	WAT187-9750-1750-E8D	
9.375	2	0.187	WAT187-9750-2000-E8D	
9.5	0.75	0.125	WAT125-9750-750-E8D	
9.5	0.875	0.125	WAT125-9750-875-E8D	
9.5	1	0.125	WAT125-9750-1000-E8D	
9.5	1.25	0.125	WAT125-9750-1250-E8D	
9.5	1.5	0.125	WAT125-9750-1500-E8D	
9.5	1.75	0.125	WAT125-9750-1750-E8D	
9.5	2	0.125	WAT125-9750-2000-E8D	
10	9.625	0.75	0.187	WAT187-10000-750-E8D
	9.625	0.875	0.187	WAT187-10000-875-E8D
	9.625	1	0.187	WAT187-10000-1000-E8D
	9.625	1.25	0.187	WAT187-10000-1250-E8D
	9.625	1.5	0.187	WAT187-10000-1500-E8D
	9.625	1.75	0.187	WAT187-10000-1750-E8D
	9.625	2	0.187	WAT187-10000-2000-E8D
	9.625	2.25	0.187	WAT187-10000-2250-E8D
	9.75	0.75	0.125	WAT125-10000-750-E8D
	9.75	0.875	0.125	WAT125-10000-875-E8D
	9.75	1	0.125	WAT125-10000-1000-E8D
	9.75	1.25	0.125	WAT125-10000-1250-E8D
9.75	1.5	0.125	WAT125-10000-1500-E8D	
9.75	1.75	0.125	WAT125-10000-1750-E8D	
9.75	2	0.125	WAT125-10000-2000-E8D	
9.75	2.25	0.125	WAT125-10000-2250-E8D	
10.5	10.125	0.75	0.187	WAT187-10500-750-E8D
	10.125	0.875	0.187	WAT187-10500-875-E8D
	10.125	1	0.187	WAT187-10500-1000-E8D
	10.125	1.25	0.187	WAT187-10500-1250-E8D
	10.125	1.5	0.187	WAT187-10500-1500-E8D
	10.125	1.75	0.187	WAT187-10500-1750-E8D
	10.13	2	0.187	WAT187-10500-2000-E8D
	10.25	0.75	0.125	WAT125-10500-750-E8D
	10.25	0.875	0.125	WAT125-10500-875-E8D
	10.25	1	0.125	WAT125-10500-1000-E8D
	10.25	1.25	0.125	WAT125-10500-1250-E8D
	10.25	1.5	0.125	WAT125-10500-1500-E8D
10.25	1.75	0.125	WAT125-10500-1750-E8D	
10.25	2	0.125	WAT125-10500-2000-E8D	

5.2

5.3 RGR rod guide rings, metric sizes

d 12 – 140 mm

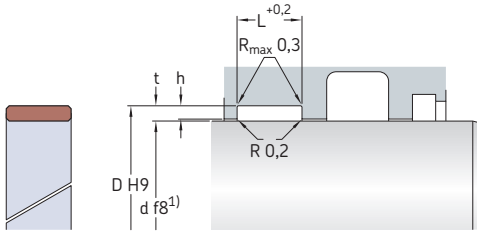

$$h \geq t/2$$

Dimensions				Designation	Dimensions				Designation
d	D	L	t		d	D	L	t	
mm				-	mm				-
12	15	6,3	1,5	RGR 12x15x6.3-PF	30	33,1	4	1,55	RGR 30x33.1x4-PF
	15,1	4	1,55	RGR 12x15.1x4-PF		34	10	2	RGR 30x34x10-PF
14	17,1	4	1,55	RGR 14x17.1x4-PF		35	5,6	2,5	RGR 30x35x5.6-PF
15	18,1	4	1,55	RGR 15x18.1x4-PF	32	35	5,6	1,5	RGR 32x35x5.6-PF
16	19	6	1,5	RGR 16x19x6-PF		35,1	4,2	1,55	RGR 32x35.1x4.2-PF
	19,1	4	1,55	RGR 16x19.1x4-PF		36	10	2	RGR 32x36x10-PF
	20	10	2	RGR 16x20x10-PF		36	15	2	RGR 32x36x15-PF
18	21,1	4	1,55	RGR 18x21.1x4-PF	36	20	2	RGR 32x36x20-PF	
	20	23	10	1,5	RGR 20x23x10-PF	37	5,6	2,5	RGR 32x37x5.6-PF
		23,1	4	1,55	RGR 20x23.1x4-PF	37	9,7	2,5	RGR 32x37x9.7-PF
24		5,6	2	RGR 20x24x5.6-PF	38	10	3	RGR 32x38x10-PF	
22	25	10	1,5	RGR 22x25x10-PF	35	38	10	1,5	RGR 35x38x10-PF
	25,1	4	1,55	RGR 22x25.1x4.0-PF		39	20	2	RGR 35x39x20-PF
	25,1	4	1,55	RGR 22x25.1x4-PF		40	5,6	2,5	RGR 35x40x5.6-PF
25	28	6	1,5	RGR 25x28x6-PF		40	9,7	2,5	RGR 35x40x9.7-PF
	28	10	1,5	RGR 25x28x10-PF	41	10	3	RGR 35x41x10-PF	
	28	20	1,5	RGR 25x28x20-PF	36	40	10	2	RGR 36x40x10-PF
	28,1	4	1,55	RGR 25x28.1x4-PF		40	30	2	RGR 36x40x30-PF
	28,1	4,2	1,55	RGR 25x28.1x4.2-PF	41	5,6	2,5	RGR 36x41x5.6-PF	
	29	5,6	2	RGR 25x29x5.6-PF	41	9,7	2,5	RGR 36x41x9.7-PF	
29	29	10	2	RGR 25x29x10-PF	42	10	3	RGR 36x42x10-PF	
	29	20	2	RGR 25x29x20-PF	40	43	5,6	1,5	RGR 40x43x5.6-PF
	30	5,6	2,5	RGR 25x30x5.6-PF		44	10	2	RGR 40x44x10-PF
	31	10	3	RGR 25x31x10-PF		44	20	2	RGR 40x44x20-PF
	28	31,1	4	1,55		RGR 28x31.1x4-PF	44	25	2
32		10	2	RGR 28x32x10-PF		45	5,6	2,5	RGR 40x45x5.6-PF
32	33	5,6	2,5	RGR 28x33x5.6-PF	45	9,7	2,5	RGR 40x45x9.7-PF	
	34	10	3	RGR 28x34x10-PF	46	10	3	RGR 40x46x10-PF	
	33	15	3		RGR 40x46x15-PF	46	20	3	RGR 40x46x20-PF
		25	3		RGR 40x46x25-PF				

¹⁾ Adjustments according to tolerances provided for rod seal are possible, however, the maximum e-gap also need to be considered (→ Gap extrusion, page 34)

Dimensions				Designation
d	D	L	t	
mm				-
45	49	15	2	RGR 45x49x15-PF
	50	5,6	2,5	RGR 45x50x5.6-PF
	50	9,7	2,5	RGR 45x50x9.7-PF
	51	13	3	RGR 45x51x13-PF
	51	20	3	RGR 45x51x20-PF
	51	40	3	RGR 45x51x40-PF
50	55	5,6	2,5	RGR 50x55x5.6-PF
	55	9,7	2,5	RGR 50x55x9.7-PF
	55	15	2,5	RGR 50x55x15-PF
	56	13	3	RGR 50x56x13-PF
	56	20	3	RGR 50x56x20-PF
	56	30	3	RGR 50x56x30-PF
55	60	5,6	2,5	RGR 55x60x5.6-PF
	60	9,7	2,5	RGR 55x60x9.7-PF
56	61	5,6	2,5	RGR 56x61x5.6-PF
	61	9,7	2,5	RGR 56x61x9.7-PF
	62	13	3	RGR 56x62x13-PF
	62	16	3	RGR 56x62x16-PF
	62	30	3	RGR 56x62x30-PF
	62	40	3	RGR 56x62x40-PF
60	65	5,6	2,5	RGR 60x65x5.6-PF
	65	9,7	2,5	RGR 60x65x9.7-PF
	65	15	2,5	RGR 60x65x15-PF
	66	13	3	RGR 60x66x13-PF
	66	20	3	RGR 60x66x20-PF
	66	30	3	RGR 60x66x30-PF
63	68	5,6	2,5	RGR 63x68x5.6-PF
	68	9,7	2,5	RGR 63x68x9.7-PF
	68	15	2,5	RGR 63x68x15-PF
	69	13	3	RGR 63x69x13-PF
	69	20	3	RGR 63x69x20-PF
	69	30	3	RGR 63x69x30-PF
65	70	9,7	2,5	RGR 65x70x9.7-PF
	71	13	3	RGR 65x71x13-PF
	71	20	3	RGR 65x71x20-PF
	71	40	3	RGR 65x71x40-PF
70	75	9,7	2,5	RGR 70x75x9.7-PF
	76	13	3	RGR 70x76x13-PF
	76	20	3	RGR 70x76x20-PF
	76	30	3	RGR 70x76x30-PF
	76	40	3	RGR 70x76x40-PF
	76	50	3	RGR 70x76x50-PF
75	80	9,7	2,5	RGR 75x80x9.7-PF
	81	13	3	RGR 75x81x13-PF
	81	20	3	RGR 75x81x20-PF
	81	30	3	RGR 75x81x30-PF
	81	60	3	RGR 75x81x60-PF
80	85	9,7	2,5	RGR 80x85x9.7-PF
	85	15	2,5	RGR 80x85x15-PF
	86	13	3	RGR 80x86x13-PF
	86	20	3	RGR 80x86x20-PF
		86	25	3
	86	30	3	RGR 80x86x30-PF
	86	40	3	RGR 80x86x40-PF
	86	50	3	RGR 80x86x50-PF

Dimensions				Designation
d	D	L	t	
mm				-
85	90	9,7	2,5	RGR 85x90x9.7-PF
	90	15	2,5	RGR 85x90x15-PF
	91	13	3	RGR 85x91x13-PF
	91	20	3	RGR 85x91x20-PF
	91	25	3	RGR 85x91x25-PF
90	95	9,7	2,5	RGR 90x95x9.7-PF
	95	15	2,5	RGR 90x95x15-PF
	96	13	3	RGR 90x96x13-PF
	96	20	3	RGR 90x96x20-PF
	96	30	3	RGR 90x96x30-PF
	96	40	3	RGR 90x96x40-PF
95	100	9,7	2,5	RGR 95x100x9.7-PF
	100	15	2,5	RGR 95x100x15-PF
100	105	9,7	2,5	RGR 100x105x9.7-PF
	105	15	2,5	RGR 100x105x15-PF
	106	13	3	RGR 100x106x13-PF
	106	20	3	RGR 100x106x20-PF
	106	25	3	RGR 100x106x25-PF
	106	30	3	RGR 100x106x30-PF
	106	40	3	RGR 100x106x40-PF
	106	50	3	RGR 100x106x50-PF
105	111	20	3	RGR 105x111x20-PF
110	115	9,7	2,5	RGR 110x115x9.7-PF
	115	15	2,5	RGR 110x115x15-PF
	116	13	3	RGR 110x116x13-PF
	116	20	3	RGR 110x116x20-PF
	116	30	3	RGR 110x116x30-PF
115	121	20	3	RGR 115x121x20-PF
120	125	9,7	2,5	RGR 120x125x9.7-PF
	125	15	2,5	RGR 120x125x15-PF
	126	40	3	RGR 120x126x40-PF
	126	50	3	RGR 120x126x50-PF
125	130	9,7	2,5	RGR 125x130x9.7-PF
	130	15	2,5	RGR 125x130x15-PF
	131	13	3	RGR 125x131x13-PF
	131	30	3	RGR 125x131x30-PF
	131	40	3	RGR 125x131x40-PF
	131	50	3	RGR 125x131x50-PF
	133	20	4	RGR 125x133x20-PF
	133	30	4	RGR 125x133x30-PF
	133	45	4	RGR 125x133x45-PF
	133	60	4	RGR 125x133x60-PF
127	133	13	3	RGR 127x133x13-PF
130	135	9,7	2,5	RGR 130x135x9.7-PF
	135	15	2,5	RGR 130x135x15-PF
135	141	90	3	RGR 135x141x90-PF
140	145	9,7	2,5	RGR 140x145x9.7-PF
	145	15	2,5	RGR 140x145x15-PF
	146	13	3	RGR 140x146x13-PF
	146	20	3	RGR 140x146x20-PF
	146	25	3	RGR 140x146x25-PF
	146	40	3	RGR 140x146x40-PF
	148	20	4	RGR 140x148x20-PF



5.3 RGR rod guide rings, metric sizes

d 150 – 365 mm

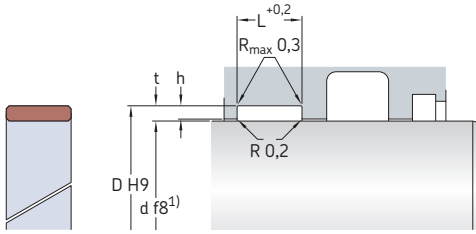

$$h \geq t/2$$

Dimensions				Designation	
d	D	L	t		
mm					
150	155	9,7	2,5	RGR 150x155x9.7-PF	
	155	15	2,5	RGR 150x155x15-PF	
	156	19,5	3	RGR 150x156x19.5-PF	
	156	30	3	RGR 150x156x30-PF	
	158	20	4	RGR 150x158x20-PF	
160	165	9,7	2,5	RGR 160x165x9.7-PF	
	165	15	2,5	RGR 160x165x15-PF	
	166	30	3	RGR 160x166x30-PF	
	168	30	4	RGR 160x168x30-PF	
	168	40	4	RGR 160x168x40-PF	
180	185	9,7	2,5	RGR 180x185x9.7-PF	
	185	15	2,5	RGR 180x185x15-PF	
	186	19,5	3	RGR 180x186x19.5-PF	
195	203	25	4	RGR 195x203x25-PF	
200	205	15	2,5	RGR 200x205x15-PF	
	205	25	2,5	RGR 200x205x25-PF	
210	218	25	4	RGR 210x218x25-PF	
220	225	15	2,5	RGR 220x225x15-PF	
	225	25	2,5	RGR 220x225x25-PF	
	228	25	4	RGR 220x228x25-PF	
235	243	30	4	RGR 235x243x30-PF	
250	255	15	2,5	RGR 250x255x15-PF	
	255	25	2,5	RGR 250x255x25-PF	
255	263	25	4	RGR 255x263x25-PF	
264	272	24	4	RGR 264x272x24-PF	
305	313	25	4	RGR 305x313x25-PF	
365	373	35	4	RGR 365x373x35-PF	

¹⁾ Adjustments according to tolerances provided for rod seal are possible, however, the maximum e-gap also needs to be considered (→ Gap extrusion, page 34)

5.4 PGR piston guide rings, metric sizes

D 16 – 220 mm

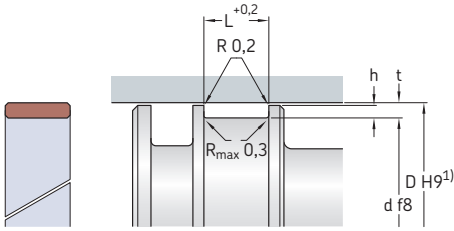

$$h \geq t/2$$

Dimensions				Designation
D	d	L	t	
mm				
16	11	5,6	2,5	PGR 16x11x5.6-PF
	12,9	4	1,55	PGR 16x12.9x4-PF
18	13	5,6	2,5	PGR 18x13x5.6-PF
	14,9	4	1,55	PGR 18x14.9x4-PF
20	15	5,6	2,5	PGR 20x15x5.6-PF
	16,9	4	1,55	PGR 20x16.9x4-PF
25	20	5,6	2,5	PGR 25x20x5.6-PF
	21,9	4	1,55	PGR 25x21.9x4-PF
30	24	10	3	PGR 30x24x10-PF
	25	5,6	2,5	PGR 30x25x5.6-PF
	26,9	4	1,55	PGR 30x26.9x4-PF
32	27	5,6	2,5	PGR 32x27x5.6-PF
	28,9	4	1,55	PGR 32x28.9x4-PF
35	30	5,6	2,5	PGR 35x30x5.6-PF
	31,9	4	1,55	PGR 35x31.9x4-PF
40	34	10	3	PGR 40x34x10-PF
	35	5,6	2,5	PGR 40x35x5.6-PF
	35	9,7	2,5	PGR 40x35x9.7-PF
	36	10	2	PGR 40x36x10-PF
	36,9	4	1,55	PGR 40x36.9x4-PF
45	39	10	3	PGR 45x39x10-PF
	40	5,6	2,5	PGR 45x40x5.6-PF
	41	12	2	PGR 45x41x12-PF
	41,9	4	1,55	PGR 45x41.9x4-PF

Dimensions				Designation
D	d	L	t	
mm				
50	44	10	3	PGR 50x44x10-PF
	45	5,6	2,5	PGR 50x45x5.6-PF
	45	6,3	2,5	PGR 50x45x6.3-PF
	45	9,7	2,5	PGR 50x45x9.7-PF
	46	12	2	PGR 50x46x12-PF
55	46,9	4	1,55	PGR 50x46.9x4-PF
	50	4	2,5	PGR 55x50x4-PF
	50	5,6	2,5	PGR 55x50x5.6-PF
60	50	9,7	2,5	PGR 55x50x9.7-PF
	50	25	2,5	PGR 55x50x25-PF
	54	10	3	PGR 60x54x10-PF
63	54	13	3	PGR 60x54x13-PF
	54	20	3	PGR 60x54x20-PF
	54	30	3	PGR 60x54x30-PF
	55	5,6	2,5	PGR 60x55x5.6-PF
	55	6,3	2,5	PGR 60x55x6.3-PF
65	55	9,7	2,5	PGR 60x55x9.7-PF
	57	13	3	PGR 63x57x13-PF
	57	20	3	PGR 63x57x20-PF
	58	5,6	2,5	PGR 63x58x5.6-PF
	58	6,3	2,5	PGR 63x58x6.3-PF
	58	9,7	2,5	PGR 63x58x9.7-PF
	58	10	2,5	PGR 63x58x10-PF
	59	13	3	PGR 65x59x13-PF
59	20	3	PGR 65x59x20-PF	
60	60	5,6	2,5	PGR 65x60x5.6-PF
	60	9,7	2,5	PGR 65x60x9.7-PF

¹⁾ Adjustments according to tolerance provided for piston seal are possible, however, the maximum e-gap also need to be considered (→ Gap extrusion, page 34)

Dimensions				Designation
D	d	L	t	
mm				-
70	64	13	3	PGR 70x64x13-PF
	64	20	3	PGR 70x64x20-PF
	65	5,6	2,5	PGR 70x65x5,6-PF
	65	9,7	2,5	PGR 70x65x9,7-PF
	65	20	2,5	PGR 70x65x20-PF
75	70	5,6	2,5	PGR 75x70x5,6-PF
	70	9,7	2,5	PGR 75x70x9,7-PF
80	72	12	4	PGR 80x72x12-PF
	74	13	3	PGR 80x74x13-PF
	74	20	3	PGR 80x74x20-PF
	74	25	3	PGR 80x74x25-PF
	75	5,6	2,5	PGR 80x75x5,6-PF
85	75	9,7	2,5	PGR 80x75x9,7-PF
	75	15	2,5	PGR 80x75x15-PF
	79	30	3	PGR 85x79x30-PF
80	80	5,6	2,5	PGR 85x80x5,6-PF
	80	9,7	2,5	PGR 85x80x9,7-PF
	84	13	3	PGR 90x84x13-PF
90	84	20	3	PGR 90x84x20-PF
	85	5,6	2,5	PGR 90x85x5,6-PF
	85	9,7	2,5	PGR 90x85x9,7-PF
	89	13	3	PGR 95x89x13-PF
95	90	9,7	2,5	PGR 95x90x9,7-PF
	94	13	3	PGR 100x94x13-PF
100	94	20	3	PGR 100x94x20-PF
	94	25	3	PGR 100x94x25-PF
	94	30	3	PGR 100x94x30-PF
	95	9,7	2,5	PGR 100x95x9,7-PF
	104	13	3	PGR 110x104x13-PF
110	104	20	3	PGR 110x104x20-PF
	104	30	3	PGR 110x104x30-PF
	105	9,7	2,5	PGR 110x105x9,7-PF
	105	15	2,5	PGR 110x105x15-PF
	109	13	3	PGR 115x109x13-PF
115	110	9,7	2,5	PGR 115x110x9,7-PF
	114	13	3	PGR 120x114x13-PF
120	114	20	3	PGR 120x114x20-PF
	114	30	3	PGR 120x114x30-PF
	114	40	3	PGR 120x114x40-PF
	115	9,7	2,5	PGR 120x115x9,7-PF
	119	13	3	PGR 125x119x13-PF
125	119	15	3	PGR 125x119x15-PF
	119	20	3	PGR 125x119x20-PF
	119	25	3	PGR 125x119x25-PF
	119	30	3	PGR 125x119x30-PF
	120	9,7	2,5	PGR 125x120x9,7-PF
130	124	13	3	PGR 130x124x13-PF
	124	30	3	PGR 130x124x30-PF
	125	9,7	2,5	PGR 130x125x9,7-PF
135	129	13	3	PGR 135x129x13-PF

Dimensions				Designation
D	d	L	t	
mm				-
140	134	13	3	PGR 140x134x13-PF
	134	20	3	PGR 140x134x20-PF
	134	25	3	PGR 140x134x25-PF
	134	30	3	PGR 140x134x30-PF
	135	9,7	2,5	PGR 140x135x9,7-PF
	135	15	2,5	PGR 140x135x15-PF
	145	139	30	3
150	144	13	3	PGR 150x144x13-PF
	144	20	3	PGR 150x144x20-PF
	144	30	3	PGR 150x144x30-PF
	144	40	3	PGR 150x144x40-PF
	145	9,7	2,5	PGR 150x145x9,7-PF
	145	15	2,5	PGR 150x145x15-PF
155	149	13	3	PGR 155x149x13-PF
160	154	13	3	PGR 160x154x13-PF
	154	15	3	PGR 160x154x15-PF
	154	19,5	3	PGR 160x154x19,5-PF
	154	30	3	PGR 160x154x30-PF
	154	35	3	PGR 160x154x35-PF
	154	50	3	PGR 160x154x50-PF
	155	9,7	2,5	PGR 160x155x9,7-PF
155	15	2,5	PGR 160x155x15-PF	
170	160	20	5	PGR 170x160x20-PF
	164	19,5	3	PGR 170x164x19,5-PF
	164	20	3	PGR 170x164x20-PF
	164	30	3	PGR 170x164x30-PF
	165	9,7	2,5	PGR 170x165x9,7-PF
	165	15	2,5	PGR 170x165x15-PF
180	172	40	4	PGR 180x172x40-PF
	174	13	3	PGR 180x174x13-PF
	174	19,5	3	PGR 180x174x19,5-PF
	174	30	3	PGR 180x174x30-PF
	175	9,7	2,5	PGR 180x175x9,7-PF
	175	15	2,5	PGR 180x175x15-PF
	184	25	3	PGR 190x184x25-PF
190	184	30	3	PGR 190x184x30-PF
	185	9,7	2,5	PGR 190x185x9,7-PF
	185	15	2,5	PGR 190x185x15-PF
	192	25	4	PGR 200x192x25-PF
200	194	20	3	PGR 200x194x20-PF
	194	30	3	PGR 200x194x30-PF
	194	50	3	PGR 200x194x50-PF
	195	9,7	2,5	PGR 200x195x9,7-PF
210	195	15	2,5	PGR 200x195x15-PF
	195	20	2,5	PGR 200x195x20-PF
	205	9,7	2,5	PGR 210x205x9,7-PF
220	205	15	2,5	PGR 210x205x15-PF
	212	20	4	PGR 220x212x20-PF
210	212	30	4	PGR 220x212x30-PF
	214	19,5	3	PGR 220x214x19,5-PF
	214	30	3	PGR 220x214x30-PF
	215	9,7	2,5	PGR 220x215x9,7-PF
	215	15	2,5	PGR 220x215x15-PF

5.4

5.4 PGR piston guide rings, metric sizes

D 230 – 400 mm

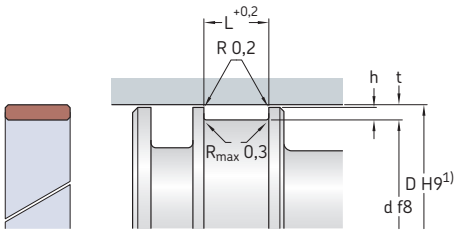

$$h \geq t/2$$

Dimensions				Designation
D	d	L	t	
mm				-
230	225	15	2,5	PGR 230x225x15-PF
240	232	25	4	PGR 240x232x25-PF
	232	40	4	PGR 240x232x40-PF
	235	9,7	2,5	PGR 240x235x9.7-PF
	235	15	2,5	PGR 240x235x15-PF
250	242	20	4	PGR 250x242x20-PF
	242	25	4	PGR 250x242x25-PF
	242	40	4	PGR 250x242x40-PF
	244	19,5	3	PGR 250x244x19.5-PF
	244	50	3	PGR 250x244x50-PF
	245	9,7	2,5	PGR 250x245x9.7-PF
245	15	2,5	PGR 250x245x15-PF	
260	255	9,7	2,5	PGR 260x255x9.7-PF
	255	15	2,5	PGR 260x255x15-PF
270	262	25	4	PGR 270x262x25-PF
	262	30	4	PGR 270x262x30-PF
280	272	25	4	PGR 280x272x25-PF
	275	15	2,5	PGR 280x275x15-PF
	275	25	2,5	PGR 280x275x25-PF
300	292	20	4	PGR 300x292x20-PF
	292	25	4	PGR 300x292x25-PF
	292	40	4	PGR 300x292x40-PF
	295	15	2,5	PGR 300x295x15-PF
	295	25	2,5	PGR 300x295x25-PF
400	392	30	4	PGR 400x392x30-PF

¹⁾ Adjustments according to tolerance provided for piston seal are possible, however, the maximum e-gap also need to be considered (→ Gap extrusion, page 34)

Guide strips

SKF guide strips are made of PTFE as standard and should only be used in light duty applications or when fluid, temperature, friction, or speed do not allow any other material. They are typically used with PTFE sealing systems (→ **fig. 6**). At system operating pressures over 200 bar (2 900 *psi*), contact SKF.

PTFE guide strips are available with different designs (→ **fig. 7**) and can be cut with different configurations (→ **fig. 8**).

Guide strips cut to length

Based on the hardware dimensions, SKF can supply guide strips with specified lengths. They are designated according to a system that states the type and design, dynamic diameter, housing groove diameter, housing groove width, type of cut and material (→ **table 2, page 286**).

For additional information and order assistance, contact SKF.

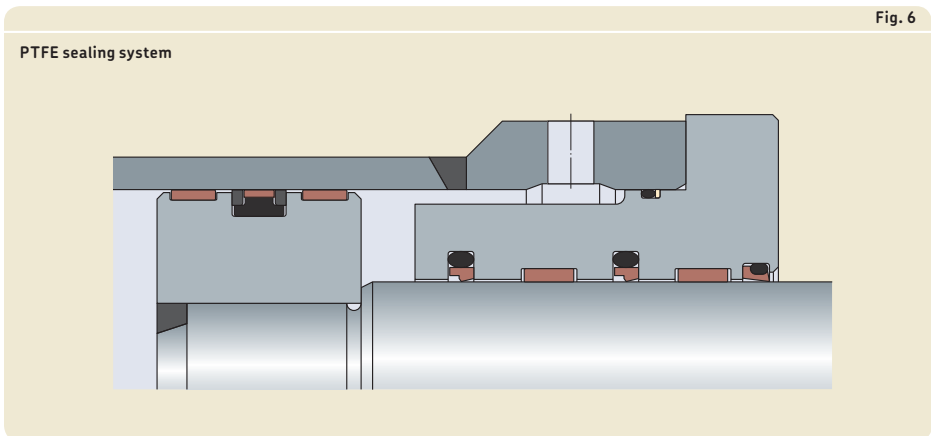

Fig. 7

Guide strip types and designs



Type SB with a basic design



Type SB/C with four chamfered edges

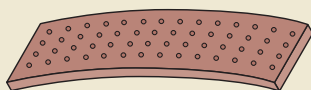

Type SBC with a coined surface



Type SBE etched on both surfaces

Fig. 8

Guide strips cut configurations

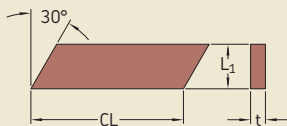
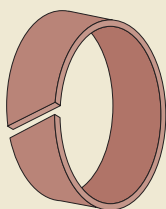

A cut forming an angle of 30° is the basic design for applications with reciprocating movements.

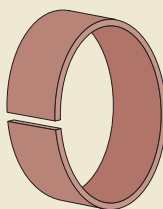

A straight cut is used in applications with rotating movements, designation suffix O.

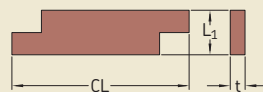
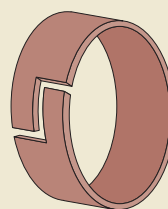

A stepped cut is used in special applications and when the guide strip also has a sealing function, designation suffix S.

Designation system for guide strips with individual length

SB 200×195×12×45-292

Type and design

Dynamic diameter [mm]

Housing groove diameter [mm]

Housing groove width [mm]

Type of cut

no value = 30° angle cut (→ **fig. 8**)

value = angle cut (other than 30°)

0 = straight cut (→ **fig. 8**)

S = stepped cut (→ **fig. 8**)

Material code (→ **table 6, page 29**)

Guide strips uncut

SKF can also supply uncut guide strips. They are designated by the type and design (→ **fig. 7, page 285**), guide strip thickness t and housing groove width in millimetres, material code, and length in metres, such as SB 2x8,1-292 / 25 m.

For additional information and order assistance, contact SKF.

Calculating the guide strip length

The individual guide strip length CL can be calculated using the formulas provided in **table 3**.

Table 3

Guide strip length CL

Material code

Guide strip for piston applications

Guide strip for rod applications

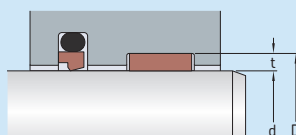
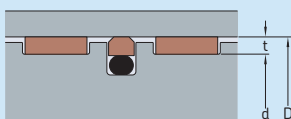

PTFE 292

$$CL = 3,11 (D - t) - 0,8$$

$$CL = 3,11 (d + t) - 0,8$$

CL = guide strip length [mm]

D = cylinder bore diameter or guide ring groove diameter in the head [mm]

d = guide ring groove diameter in the piston or rod diameter [mm]

t = guide strip thickness [mm]

More guides

Spark rings

Spark rings (also known as contamination rings, → **fig. 9**) are not technically guide rings, as they are not intended to accommodate radial loads. They rather protect the guides and piston seals from damage due to contamination particles or combustion of gases in the fluid media (diesel effect). SKF supplies spark rings in a variety of PTFE materials.

Customized machined guide profiles

SKF can manufacture a wide variety of guide profiles (→ **fig. 10**) with different materials and customized sizes with its industry-leading SKF SEAL JET production system. SKF can supply customized machined guide rings in close partnership with customers from the design phase to serial production.

For additional information about customized machined profiles, contact SKF.

Fig. 9

Guide rings combined with spark rings

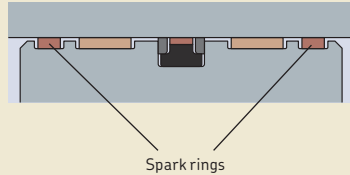
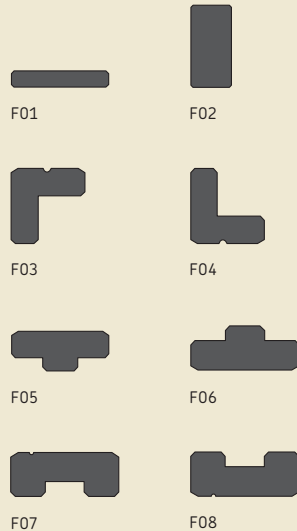
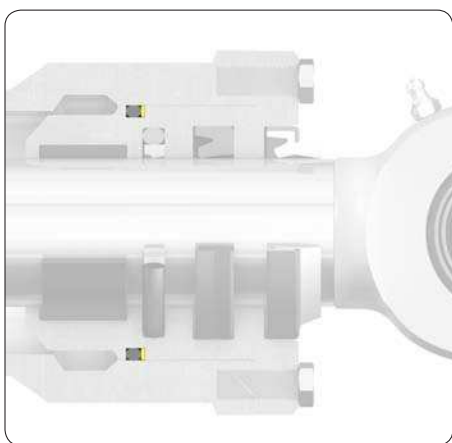
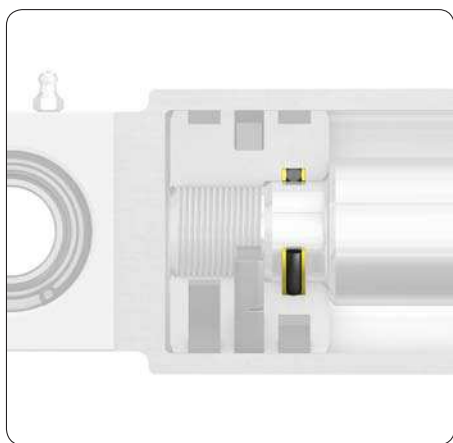
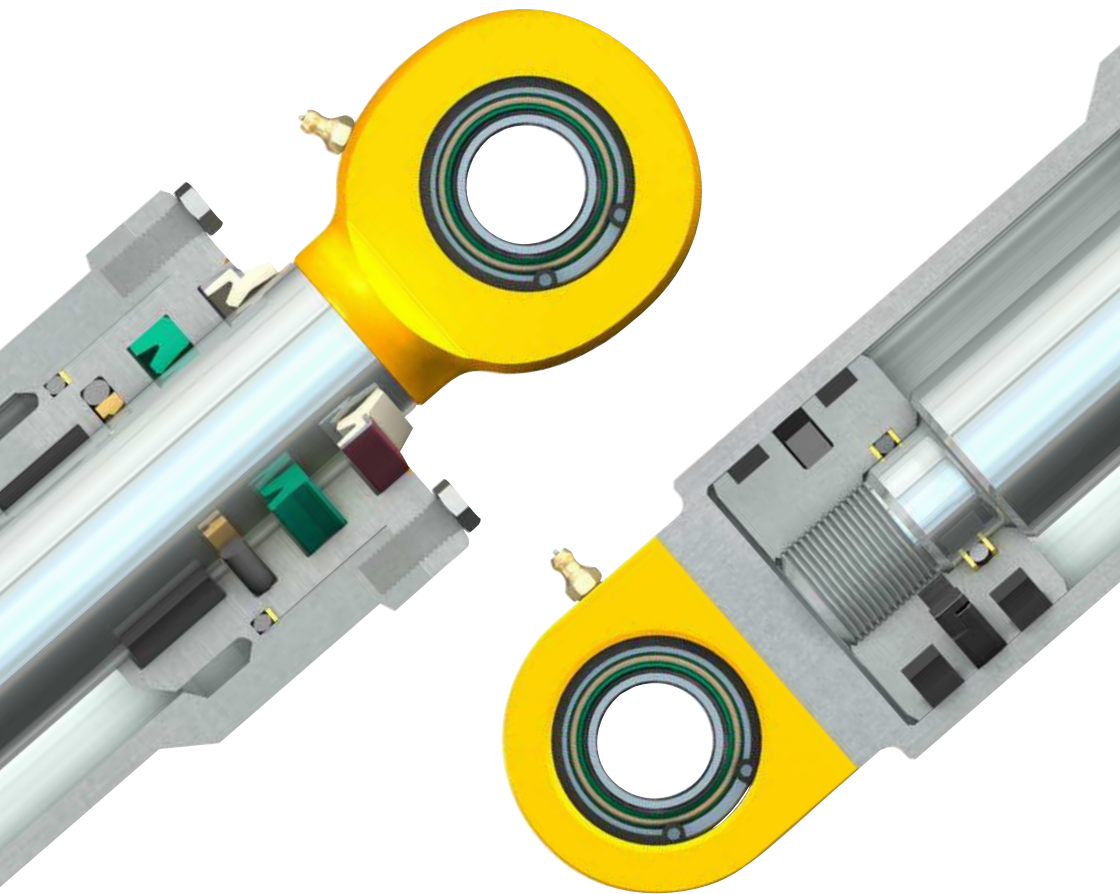

Fig. 10

Examples of SKF SEAL JET guide profiles





O-rings and back-up rings

Basics	292	Profile data	
Designations	292	6.1 OR O-rings in static radial sealing, metric sizes	300
Materials	292	6.2 OR O-rings in static radial sealing, inch sizes	316
Standards and sizes	294	6.3 STR Back-up rings in static radial sealing, metric sizes	324
Dimension standards	294	6.4 STR Back-up rings in static radial sealing, inch sizes by dash-number, metric dimensions	328
Inside diameter/cross section proportion	294	6.5 STR Back-up rings in static radial sealing, inch sizes by dash-number	338
Tolerance standard	294		
Surface standard	295	Other O-ring sealing and ring materials	344
Housing design and dimensions	297	Dynamic radial sealing	344
Housing dimensions for static radial sealing	297	Static axial sealing	344
Lead-in chamfers	297	PTFE encapsulated O-rings	345
Extrusion gaps and back-up rings	298	Back-up rings made of thermoplastic polyester elastomer	345
		Back-up rings made of PTFE	345

Basics

O-rings are one of the most common sealing solutions. SKF supplies O-rings in a wide range of sizes and different materials, which make them appropriate for a wide variety of operating conditions and applications. They are easy to install and they enable a simple and cost-effective seal housing design.

O-rings maintain sealing contact force by radial or axial deformation in the seal housing between two machine components. The most important criteria that influence the maximum operating pressure at which O-rings in static radial sealing can be used are the following:

- extrusion gap (→ **fig. 2, page 298**)
- material (→ *Materials, page 26*)
- sealed fluid
- temperature

Under specific conditions, there is a risk for gap extrusion (→ *Extrusion gaps and back-up rings, page 298*). Back-up rings prevent O-rings from gap extrusion in static radial sealing.

O-rings are used in a wide variety of applications sealing various media. This catalogue focuses on sealing systems for hydraulic cylinders. Therefore, this chapter and provided recommendations apply to static sealing of common mineral-based hydraulic fluids (→ *Hydraulic fluids, page 31*).

More information

Counter-surface finish properties . . .	22
Materials	26
Hydraulic fluids	31
Gap extrusion	34
Storage	36
Installation and assembly	38

Designations

The designations of SKF O-rings (→ **table 1**) in both metric and inch sizes contain their dimensions in metric units.

The designations of SKF back-up rings (→ **table 2**) in metric sizes contain their dimensions in metric units, whereas those in inch sizes contain their dash-number.

The product tables for both are provided in inch and metric sizes. If applicable, the unique dash-numbers for O-ring sizes in accordance with standards AS586 and ISO 3601 are also listed there.

Materials

The O-rings listed in this catalogue are made of nitrile rubber (NBR) with 70 shA hardness as standard. This is the most common O-ring material and hardness used in hydraulic cylinder applications. On request, SKF can supply alternative hardnesses such as 80 shA or 90 shA. However, SKF generally recommends choosing O-rings with 70 shA and combining them with one or two back-up rings (→ *Extrusion gaps and back-up rings, page 298*). At operating temperatures above 100 °C (210 °F), fluorocarbon rubber (FKM) or hydrogenated nitrile rubber (HNBR) can be an appropriate materials, depending on the fluid.

SKF back-up rings listed in this catalogue are made of polyurethane (TPU). On request, SKF can supply alternative materials and various hardness grades. Common back-up ring materials are listed in the designation system (→ **table 2**).

For additional information about O-ring and back-up ring materials, refer to *Materials* (→ **page 26**).

Table 1

Designation system for SKF O-rings

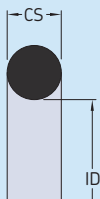

OR 99.1×5.7-N70

- O-ring _____
- Inside diameter ID [mm] _____
- Cross section diameter CS [mm] _____
- Material code (→ table 5, page 29) _____

Table 2

Designation system for SKF back-up rings

Metric sizes

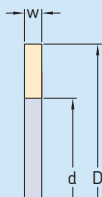

STR 90×100×1.7-Y95A

- Back-up ring _____
- Inside diameter d [mm] _____
- Outside diameter D [mm] _____
- Width w [mm] _____
- Material code^{*)} _____

Inch sizes with a dash-number



STR 19-342-395A

- Back-up ring dash-number series _____
- Dash-number _____
- Material code^{*)} _____

^{*)} Material codes

- Y95A** Polyurethane 95 shA (yellow)
- 395A** Polyurethane 98 shA (black)
- 100** Unfilled PTFE (white)

Standards and sizes

Dimension standards

SKF can supply O-rings in a wide range of sizes in accordance with various O-ring standards.

Table 3 provides the most common national and international O-ring standards and their relevant sizes.

Inside diameter/cross section proportion

O-rings used in more demanding applications, such as those with higher operating pressures or larger misalignments, may require larger cross sections. SKF recommends inside

diameter ID and cross section proportions as provided in **diagram 1**.

Tolerance standard

SKF supplies all O-rings with dimensional tolerances in accordance with ISO 3601-1 Class B (→ **table 4**). They are suitable for any elastomer material provided that appropriate tooling is used, whereas the tooling most commonly used is based upon the shrinkage of nitrile rubber (NBR) with 70 shA hardness.

Diagram 1

O-ring inside diameter/cross section proportion

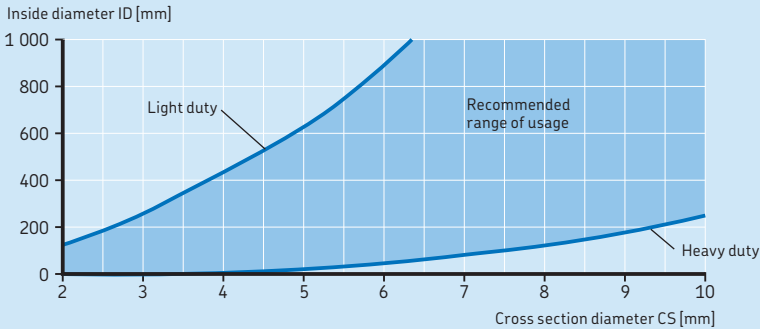

O-ring standards and relevant sizes

Standard

DIN 3771:1984

Cross section diameter CS	Inside diameter	
	ID _{min}	ID _{max}
mm	mm	
1,8	1,8	17
2,65	14	38,7
3,55	18	200
5,3	40	400
7	206	670

ISO 3601-1 Class B, AS568

Cross section diameter CS	Inside diameter	
	ID _{min}	ID _{max}
mm	mm	
1,78	1,78	133,07
2,62	1,24	247,32
3,53	4,34	456,06
5,33	10,46	658,88
6,99	113,67	658,88

BS 4518

Cross section diameter CS	Inside diameter	
	ID _{min}	ID _{max}
mm	mm	
1,6	3,1	37,1
2,4	3,6	69,6
3	19,5	249,5
5,7	44,3	499,3
8,4	144,1	249,1

JIS 240 P+G

Cross section diameter CS	Inside diameter	
	ID _{min}	ID _{max}
mm	mm	
1,9	2,8	9,8
2,4	9,8	21,8
3,1	24,4	144,4
3,5	21,7	49,7
5,7	47,6	299,3
8,4	149,5	399,5

Surface standard

SKF supplies O-rings that all have surfaces in accordance with ISO 3601-3 (→ **table 5, page 296**). This standard provides maximum acceptable imperfections and quality criteria for O-ring surfaces.

Table 4

Tolerances in accordance with ISO 3601-1 Class B



Inside diameter ID

The tolerance ΔID can be calculated using

$$\Delta ID = \pm[(ID^{0,95} \times 0,009) + 0,11]$$

Calculation example:

What is the tolerance ΔID of an O-ring with $ID = 94,5$ mm?

$$\begin{aligned} \Delta ID &= \pm[(94,5^{0,95} \times 0,009) + 0,11] \\ &= \pm[(75,277 \times 0,009) + 0,11] \\ &= \pm[0,677 + 0,11] \\ &= \pm 0,79 \text{ mm} \end{aligned}$$

Table 3

SMS 1586





Cross section diameter CS	Inside diameter	
	ID _{min}	ID _{max}
mm	mm	
1,6	3,1	37,1
2,4	3,3	17,3
3	19,2	44,2
5,7	44,2	144,3
8,4	144,1	249,1

Cross section diameter CS

over	incl.	Tolerance
mm		mm
0,8	2,25	± 0,08
2,25	3,15	± 0,09
3,15	4,5	± 0,1
4,5	6,3	± 0,13
6,3	8,4	± 0,15

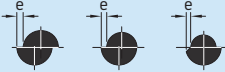
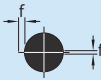
Table 5

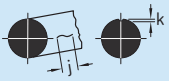
Maximum acceptable surface imperfections in accordance with ISO 3601-3

Surface imperfection category Schematic illustration	Letter symbol	Maximum acceptable limits Grade N O-rings					Grade S O-rings				
		Cross section diameter CS					Cross section diameter CS				
		>0,8	>2,25	>3,15	>4,50	>6,30	>0,8	>2,25	>3,15	>4,50	>6,30
		≤2,25	≤3,15	≤4,50	≤6,30	≤8,40	≤2,25	≤3,15	≤4,50	≤6,30	≤8,40
		mm					mm				
Offset (off register and mismatch)											
	e	0,08	0,1	0,13	0,15	0,15	0,08	0,08	0,1	0,12	0,13
Combined flash, offset and parting line projection											
	f	0,1	0,12	0,14	0,16	0,18	0,1	0,1	0,13	0,15	0,15
Backrind											
	g	0,18	0,27	0,36	0,53	0,7	0,1	0,15	0,2	0,2	0,3
	h	0,08	0,08	0,1	0,1	0,13	0,05	0,08	0,1	0,1	0,13
Excessive trimming											
	-	Departure from a circular cross section due to trimming is allowed provided that the resultant surface is smoothly blended and is within the size tolerance limits for CS.									
Flow marks (radial orientation of flow marks is not permissible)											
	j	1,5 ¹⁾	1,5 ¹⁾	6,5 ¹⁾	6,5 ¹⁾	6,5 ¹⁾	1,5 ¹⁾	1,5 ¹⁾	5 ¹⁾	5 ¹⁾	5 ¹⁾
	k	0,08	0,08	0,08	0,08	0,08	0,05	0,05	0,05	0,05	0,05
Non-fills and indentations (including parting line indentation)											
	l	0,6	0,8	1	1,3	1,7	0,15	0,25	0,4	0,63	1
	m	0,08	0,08	0,1	0,1	0,13	0,08	0,08	0,1	0,1	0,13
Foreign material											
	-	Not permitted					Not permitted				

¹⁾ Or 0,05 x ID (O-ring inside diameter), whichever is greater

Housing design and dimensions

Housing dimensions for static radial sealing

O-rings for static (non-moving) sealing can be used in a wide variety of applications and arrangements. The most common arrangement in hydraulic cylinder applications is static radial sealing between coaxial cylindrical parts. The O-ring is installed in a housing that is machined either as an outside or inside groove (\rightarrow **fig. 1**) in one of the two cylindrical parts.

The housing dimensions for static radial sealing O-rings are listed in the product tables.

Housing groove edges

All housing groove edges should be smoothed and rounded off (\rightarrow **fig. 1**) to $r = 0,1$ to $0,2$ mm (0.004 to $0,008$ in.).

Lead-in chamfers

All edges and openings through which the O-ring has to pass during the assembly should have appropriate lead-in chamfers and should be well rounded off (\rightarrow **table 6**). The chamfers facilitate assembly and protect the O-ring from damage during the installation process. The O-ring and all surrounding parts should be well lubricated before assembly, preferably with the same fluid as used in the hydraulic system, ensuring compatibility with seals and cylinder components.

Fig. 1

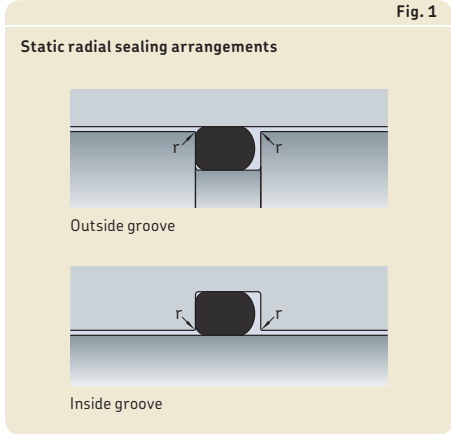

Table 6

Lead-in chamfers for O-rings

Inside chamfer

Outside chamfer

Hole

Cross section diameter		Chamfer length
CS	incl.	C
from		min.
mm		mm
1	1,5	1,5
1,6	2	2
2,4	3	2,5
3,53	4,5	3,5
5	5,7	4,5
6	8,4	5,5

O-rings and back-up rings

Extrusion gaps and back-up rings

The size of the permissible extrusion gap (→ *Gap extrusion*, page 34) depends mainly on the seal material, temperature and operating pressure. Harder materials (→ *Materials*, page 26) provide a certain resistance to gap extrusion. When the permissible extrusion gap for the pressure and temperature in application is exceeded, back-up rings may be used to prevent the seal pressing into the gap and causing extrusion damage and possibly even premature failure. **Figure 2** shows the O-ring behaviour at different operating pressures and conditions. In applications where the O-ring is exposed to pressure from one side only, the back-up ring is installed at the zero pressure side. For an O-ring exposed to pres-

sure from both sides, a back-up ring is installed on both sides.

For the extrusion gaps, SKF recommends machining the fits according to the following tolerance classes:

- f8 E and H9 E for diameters up to 120 mm
- f7 E and H8 E for diameters larger than 120 mm

Diagrams 2 to 4 provide guideline values for the maximum extrusion gap in relation to the operating pressure for standard O-rings without back-up ring (→ **diagram 2**) and different back-up ring materials and sizes (→ **diagrams 3 and 4**). These guideline values are based on extensive tests conducted in SKF laboratories

Fig. 2

O-ring behaviour at different operating pressures and conditions

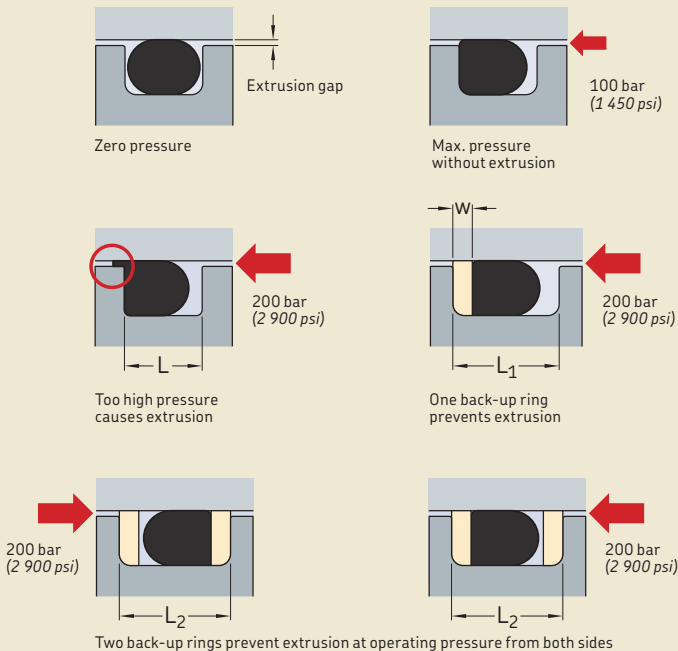

at 90 °C (195 °F) and 100 000 pressure pulses. However, other factors such as temperature and fluid can influence these guideline values and should be considered.

For additional information about O-ring and back-up ring materials, refer to *Materials* (→ page 292) and about extrusion, refer to *Gap extrusion* (→ page 34).

Housing groove width

To accommodate the additional back-up rings, the O-ring groove width L needs to be increased to L_1 for one back-up ring or L_2 for two back-up rings (→ fig. 2). The groove width dimensions are listed in the product tables.

Diagram 2

Guideline limit values for NBR O-rings, 70 shA

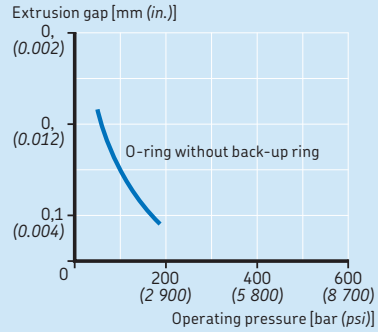

Diagram 3

Guideline limit values from test with OR 89.5×3-N70 and STR 90×95×1.3

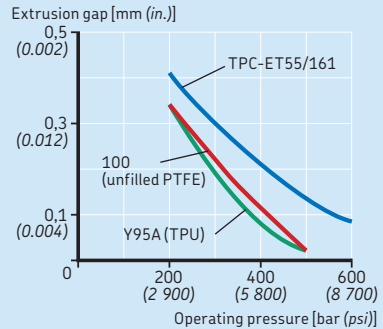
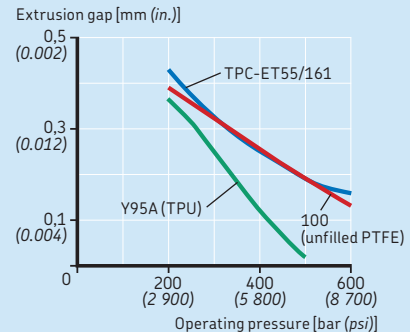

Diagram 4

Guideline limit values from test with OR 89.1×5.7-N70 and STR 90×100×1.7



6.1 OR O-rings in static radial sealing, metric sizes

ID 2,9 – 17,3 mm

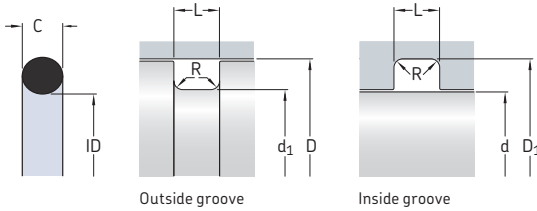

SKF recommends designing O-ring housings according to ISO 3601.
This table is a reference to O-ring sizes for common housing dimensions.

Dimensions		Outside groove				Inside groove		Dash-number	Designation
ID	CS	L +0,2	R max.	D H9	d ₁ h11	d f8	D ₁ H11		
mm								-	-
2,9	1,78	2,4	0,5	6,35	3,73	3,12	5,74	006	OR 2.90x1.78-N70
3,1	1,6	2,3	0,5	6	3,8	-	-	-	OR 3.1x1.6-N70
3,3	2,4	3,2	0,5	8	4,4	4,00	8	-	OR 3.3x2.4-N70
3,69	1,78	2,4	0,5	7,14	4,52	3,91	6,53	007	OR 3.69x1.78-N70
4,1	1,6	2,3	0,5	7	4,8	-	-	-	OR 4.1x1.6-N70
4,3	2,4	3,2	0,5	9	5,4	5,00	9	-	OR 4.3x2.4-N70
4,48	1,78	2,4	0,5	7,93	5,31	4,70	7,32	008	OR 4.48x1.78-N70
5,1	1,6	2,3	0,5	8	5,8	-	-	-	OR 5.1x1.6-N70
5,28	1,78	2,4	0,5	8,74	6,12	5,51	8,13	009	OR 5.28x1.78-N70
5,3	2,4	3,2	0,5	10	6,4	6,00	10	-	OR 5.3x2.4-N70
6,07	1,78	2,4	0,5	9,53	6,91	6,30	8,92	010	OR 6.07x1.78-N70
6,1	1,6	2,3	0,5	9	6,8	-	-	-	OR 6.1x1.6-N70
6,3	2,4	3,2	0,5	11	7,4	7,00	11	-	OR 6.3x2.4-N70
6,75	1,78	2,4	0,5	10,32	7,7	7,08	9,7	-	OR 6.75x1.78-N70
7,1	1,6	2,3	0,5	10	7,8	-	-	-	OR 7.1x1.6-N70
7,3	2,4	3,2	0,5	12	8,4	8,00	12	-	OR 7.3x2.4-N70
7,65	1,78	2,4	0,5	11,11	8,49	7,78	10,49	-	OR 7.65x1.78-N70
8,1	1,6	2,3	0,5	11	8,8	-	-	-	OR 8.1x1.6-N70
8,3	2,4	3,2	0,5	13	9,4	9,00	13	-	OR 8.3x2.4-N70
8,73	1,78	2,4	0,5	12,3	9,68	9,07	11,69	-	OR 8.73x1.78-N70
9,1	1,6	2,3	0,5	12	9,8	-	-	-	OR 9.1x1.6-N70

Dimensions				Outside groove		Inside groove		Dash-number	Designation
ID	CS	L +0,2	R max.	D H9	d ₁ h ₁₁	d f8	D ₁ H ₁₁		
mm									
9,19	2,62	3,6	0,8	14,29	10,1	9,47	13,66	110	OR 9.19x2.62-N70
9,25	1,78	2,4	0,5	12,7	10,08	9,47	12,09	012	OR 9.25x1.78-N70
9,3	2,4	3,2	0,5	14	10,4	10,00	14	–	OR 9.3x2.4-N70
9,92	2,62	3,6	0,8	15,08	10,89	10,26	14,45	–	OR 9.92x2.62-N70
10,1	1,6	2,3	0,5	13	10,8	–	–	–	OR 10.1x1.6-N70
10,3	2,4	3,2	0,5	15	11,4	11,00	15	–	OR 10.3x2.4-N70
10,78	2,62	3,6	0,8	15,88	11,69	11,05	15,24	111	OR 10.78x2.62-N70
10,82	1,78	2,4	0,5	14,3	11,68	11,10	13,72	013	OR 10.82x1.78-N70
11,1	1,6	2,3	0,5	14	11,8	–	–	–	OR 11.1x1.6-N70
11,11	1,78	2,4	0,5	14,68	12,06	11,51	14,13	–	OR 11.11x1.78-N70
11,3	2,4	3,2	0,5	16	12,4	12,00	16	–	OR 11.3x2.4-N70
11,91	2,62	3,6	0,8	17,07	12,88	12,24	16,43	–	OR 11.91x2.62-N70
12,1	1,6	2,3	0,5	15	12,8	–	–	–	OR 12.1x1.6-N70
12,3	2,4	3,2	0,5	17	13,4	13,00	17	–	OR 12.3x2.4-N70
12,37	2,62	3,6	0,8	17,46	13,27	12,65	16,84	112	OR 12.37x2.62-N70
12,42	1,78	2,4	0,5	15,88	13,26	12,70	15,32	014	OR 12.42x1.78-N70
13,1	1,6	2,3	0,5	16	13,8	–	–	–	OR 13.1x1.6-N70
	2,62	3,6	0,8	18,26	14,07	13,43	17,62	–	OR 13.1x2.62-N70
13,3	2,4	3,2	0,5	18	14,4	14,00	18	–	OR 13.3x2.4-N70
13,94	2,62	3,6	0,8	19,05	14,86	14,22	18,41	–	OR 13.94x2.62-N70
14	1,78	2,4	0,5	17,48	14,86	14,28	16,9	015	OR 14.0x1.78-N70
14,1	1,6	2,3	0,5	17	14,8	–	–	–	OR 14.1x1.6-N70
14,3	2,4	3,2	0,5	19	15,4	15,00	19	–	OR 14.3x2.4-N70
15,08	2,62	3,6	0,8	20,24	16,05	15,42	19,61	–	OR 15.08x2.62-N70
15,1	1,6	2,3	0,5	18	15,8	–	–	–	OR 15.1x1.6-N70
15,3	2,4	3,2	0,5	20	16,4	16,00	20	–	OR 15.3x2.4-N70
15,54	2,62	3,6	0,8	20,64	16,45	15,82	20,01	114	OR 15.54x2.62-N70
15,6	1,78	2,4	0,5	19,05	16,43	15,88	18,5	016	OR 15.6x1.78-N70
15,88	2,62	3,6	0,8	21,03	16,84	16,20	20,39	–	OR 15.88x2.62-N70
16,1	1,6	2,3	0,5	19	16,8	–	–	–	OR 16.1x1.6-N70
16,3	2,4	3,2	0,5	21	17,4	17,00	21	–	OR 16.3x2.4-N70
17,1	1,6	2,3	0,5	20	17,8	–	–	–	OR 17.1x1.6-N70
17,12	2,62	3,6	0,8	22,23	18,04	17,40	21,59	–	OR 17.12x2.62-N70
17,17	1,78	2,4	0,5	20,63	18,01	17,48	20,1	017	OR 17.17x1.78-N70
17,3	2,4	3,2	0,5	22	18,4	18,00	22	–	OR 17.3x2.4-N70

6.1

6.1 OR O-rings in static radial sealing, metric sizes

ID 17,86 – 37,1 mm

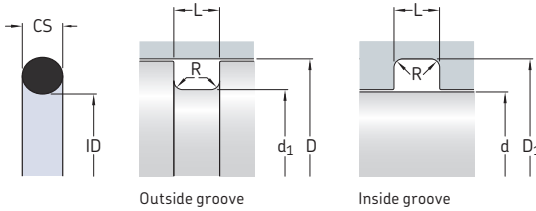

SKF recommends designing O-ring housings according to ISO 3601.
This table is a reference to O-ring sizes for common housing dimensions.

Dimensions				Outside groove		Inside groove		Dash-number	Designation
ID	CS	L +0,2	R max.	D H9	d ₁ h11	d f8	D ₁ H11		
mm								-	-
17,86	2,62	3,6	0,8	23,02	18,83	18,20	22,39	-	OR 17.86x2.62-N70
18,1	1,6	2,3	0,5	21	18,8	-	-	-	OR 18.1x1.6-N70
18,64	3,53	4,8	1	25,43	19,71	19,00	24,72	210	OR 18.64x3.53-N70
18,72	2,62	3,6	0,8	23,81	19,62	19,00	23,19	116	OR 18.72x2.62-N70
18,77	1,78	2,4	0,5	22,23	19,61	19,05	21,67	018	OR 18.77x1.78-N70
19,1	1,6	2,3	0,5	22	19,8	-	-	-	OR 19.1x1.6-N70
19,2	3	4	1	25	20,2	20,00	25	-	OR 19.2x3.0-N70
20,22	3,53	4,8	1	27	21,28	20,55	26,27	211	OR 20.22x3.53-N70
20,35	1,78	2,4	0,5	23,8	21,18	20,63	23,25	019	OR 20.35x1.78-N70
20,63	2,62	3,6	0,8	25,8	21,61	21,03	25,22	-	OR 20.63x2.62-N70
21,82	3,53	4,8	1	28,6	22,88	22,15	27,87	212	OR 21.82x3.53-N70
21,95	1,78	2,4	0,5	25,4	22,78	22,23	24,85	020	OR 21.95x1.78-N70
22,1	1,6	2,3	0,5	25	22,8	-	-	-	OR 22.1x1.6-N70
22,2	3	4	1	28	23,2	23,00	28	-	OR 22.2x3.0-N70
22,22	2,62	3,6	0,8	27,38	23,19	22,62	26,81	-	OR 22.22x2.62-N70
23,4	3,53	4,8	1	30,18	24,46	23,72	29,44	213	OR 23.4x3.53-N70
23,47	2,62	3,6	0,8	28,58	24,39	23,80	27,99	119	OR 23.47x2.62-N70
23,52	1,78	2,4	0,5	26,98	24,36	23,81	26,42	021	OR 23.52x1.78-N70
23,81	2,62	3,6	0,8	28,97	24,78	24,21	28,4	-	OR 23.81x2.62-N70
24,2	3	4	1	30	25,2	25,00	30	-	OR 24.2x3.0-N70
24,99	3,53	4,8	1	31,78	26,06	25,32	31,04	214	OR 24.99x3.53-N70

Dimensions				Outside groove		Inside groove		Dash-number	Designation
ID	CS	L +0,2	R max.	D H9	d ₁ h11	d f8	D ₁ H11		
mm									
25,07	2,62	3,6	0,8	30,18	25,99	25,40	29,59	120	OR 25.07x2.62-N70
25,1	1,6	2,3	0,5	28	25,8	–	–	–	OR 25.1x1.6-N70
25,12	1,78	2,4	0,5	28,58	25,96	25,40	28,02	022	OR 25.12x1.78-N70
25,8	3,53	4,8	1	32,58	26,86	26,13	31,85	–	OR 25.8x3.53-N70
26,2	3	4	1	32	27,2	27,00	32	–	OR 26.2x3.0-N70
26,58	3,53	4,8	1	33,35	27,63	26,90	32,62	215	OR 26.58x3.53-N70
26,64	2,62	3,6	0,8	31,75	27,56	26,98	31,17	121	OR 26.64x2.62-N70
26,7	1,78	2,4	0,5	30,18	27,56	26,98	29,6	023	OR 26.7x1.78-N70
27,1	1,6	2,3	0,5	30	27,8	–	–	–	OR 27.1x1.6-N70
28,17	3,53	4,8	1	34,95	29,23	28,50	34,22	216	OR 28.17x3.53-N70
28,25	2,62	3,6	0,8	33,33	29,14	28,58	32,77	–	OR 28.25x2.62-N70
28,3	1,78	2,4	0,5	31,75	29,13	28,58	31,2	024	OR 28.3x1.78-N70
29,1	1,6	2,3	0,5	32	29,8	–	–	–	OR 29.1x1.6-N70
29,2	3	4	1	35	30,2	30,00	35	–	OR 29.2x3.0-N70
29,74	3,53	4,8	1	36,53	30,81	30,07	35,79	–	OR 29.74x3.53-N70
29,82	2,62	3,6	0,8	34,93	30,74	30,18	34,37	123	OR 29.82x2.62-N70
29,87	1,78	2,4	0,5	33,33	30,71	30,18	32,8	025	OR 29.87x1.78-N70
31,34	3,53	4,8	1	38,13	32,41	31,67	37,39	218	OR 31.34x3.53-N70
31,42	2,62	3,6	0,8	36,5	32,31	31,75	35,94	124	OR 31.42x2.62-N70
31,47	1,78	2,4	0,5	34,93	32,31	31,75	34,37	026	OR 31.47x1.78-N70
32,1	1,6	2,3	0,5	35	32,8	–	–	–	OR 32.1x1.6-N70
32,2	3	4	1	38	33,2	33,00	38	–	OR 32.2x3.0-N70
32,92	3,53	4,8	1	39,7	33,98	33,25	38,97	–	OR 32.92x3.53-N70
32,99	2,62	3,6	0,8	38,1	33,91	33,33	37,52	–	OR 32.99x2.62-N70
33,05	1,78	2,4	0,5	36,5	33,88	33,33	35,95	027	OR 33.05x1.78-N70
34,2	3	4	1	40	35,2	35,00	40	–	OR 34.2x3.0-N70
34,52	3,53	4,8	1	41,3	35,58	34,85	40,57	220	OR 34.52x3.53-N70
34,59	2,62	3,6	0,8	39,7	35,51	34,93	39,12	126	OR 34.59x2.62-N70
34,65	1,78	2,4	0,5	38,1	35,48	34,93	37,55	028	OR 34.65x1.78-N70
35,1	1,6	2,3	0,5	38	35,8	–	–	–	OR 35.1x1.6-N70
36,1	3,53	4,8	1	42,88	37,16	36,42	42,14	221	OR 36.1x3.53-N70
36,17	2,62	3,6	0,8	41,28	37,09	36,50	40,69	127	OR 36.17x2.62-N70
36,2	3	4	1	42	37,2	37,00	42	–	OR 36.2x3.0-N70
37,1	1,6	2,3	0,5	40	37,8	–	–	–	OR 37.1x1.6-N70

6.1 OR O-rings in static radial sealing, metric sizes

ID 37,47 – 61,91 mm

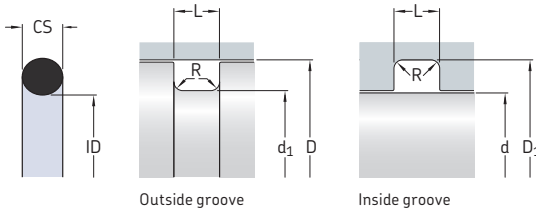

SKF recommends designing O-ring housings according to ISO 3601.
This table is a reference to O-ring sizes for common housing dimensions.

Dimensions		Outside groove				Inside groove		Dash-number	Designation
ID	CS	L +0,2	R max.	D H9	d ₁ h11	d f8	D ₁ H11		
mm									
37,47	5,33	7,1	1	47,65	38,89	38,02	46,78	325	OR 37.47x5.33-N70
37,69	3,53	4,8	1	44,48	38,76	38,02	43,74	222	OR 37.69x3.53-N70
37,77	2,62	3,6	0,8	42,88	38,69	38,10	42,29	128	OR 37.77x2.62-N70
39,2	3	4	1	45	40,2	40,00	45	-	OR 39.2x3.0-N70
39,34	2,62	3,6	0,8	44,45	40,26	39,68	43,87	129	OR 39.34x2.62-N70
39,69	3,53	4,8	1	46,49	40,77	40,02	45,74	-	OR 39.69x3.53-N70
40,65	5,33	7,1	1	50,83	42,07	41,20	49,96	326	OR 40.65x5.33-N70
40,87	3,53	4,8	1	47,65	41,94	41,20	46,91	223	OR 40.87x3.53-N70
40,95	2,62	3,6	0,8	46,03	41,84	41,28	45,47	130	OR 40.95x2.62-N70
41,28	3,53	4,8	1	48,05	42,33	41,61	47,33	-	OR 41.28x3.53-N70
42,2	3	4	1	48	43,2	43,00	48	-	OR 42.2x3.0-N70
42,52	2,62	3,6	0,8	47,63	43,44	42,88	47,07	131	OR 42.52x2.62-N70
42,86	3,53	4,8	1	49,64	43,92	43,19	48,91	-	OR 42.86x3.53-N70
43,82	5,33	7,1	1	54	45,24	44,37	53,13	327	OR 43.82x5.33-N70
44,04	3,53	4,8	1	50,83	45,11	44,37	50,09	224	OR 44.04x3.53-N70
44,12	2,62	3,6	0,8	49,2	45,01	44,45	48,64	132	OR 44.12x2.62-N70
44,2	3	4	1	50	45,2	45,00	50	-	OR 44.2x3.0-N70
	5,7	7,5	1	55	45,3	45,00	55	-	OR 44.2x5.7-N70
44,45	3,53	4,8	1	51,22	45,5	44,77	50,49	-	OR 44.45x3.53-N70
45,69	2,62	3,6	0,8	50,8	46,61	46,03	50,22	133	OR 45.69x2.62-N70
46,04	3,53	4,8	1	52,8	47,08	46,35	52,07	-	OR 46.04x3.53-N70
46,99	5,33	7,1	1	57,18	48,42	47,55	56,31	328	OR 46.99x5.33-N70

Dimensions				Outside groove		Inside groove		Dash-number	Designation
ID	CS	L +0,2	R max.	D H9	d ₁ h11	d f8	D ₁ H11		
mm									
47,22	3,53	4,8	1	54	48,29	47,55	53,26	225	OR 47.22x3.53-N70
47,29	2,62	3,6	0,8	52,38	48,19	47,63	51,82	134	OR 47.29x2.62-N70
47,63	3,53	4,8	1	54,39	48,67	47,94	53,66	–	OR 47.63x3.53-N70
48,9	2,62	3,6	0,8	53,98	49,79	49,20	53,39	135	OR 48.9x2.62-N70
49,2	5,7	7,5	1	60	50,3	50,00	60	–	OR 49.2x5.7-N70
49,21	3,53	4,8	1	55,98	50,26	49,53	55,25	–	OR 49.21x3.53-N70
49,5	3	3,7	1	55	50,2	–	–	–	OR 49.5x3.0-N70
50,16	5,33	7,1	1	60,35	51,59	50,72	59,48	329	OR 50.16x5.33-N70
50,4	3,53	4,8	1	57,18	51,46	50,72	56,44	226	OR 50.4x3.53-N70
50,47	2,62	3,6	0,8	55,58	51,39	50,80	54,99	136	OR 50.47x2.62-N70
50,8	3,53	4,8	1	57,57	51,85	51,12	56,84	–	OR 50.8x3.53-N70
52,07	2,62	3,6	0,8	57,15	52,96	52,38	56,57	137	OR 52.07x2.62-N70
52,39	3,53	4,8	1	59,17	53,45	52,70	58,42	–	OR 52.39x3.53-N70
53,34	5,33	7,1	1	63,53	54,77	53,90	62,66	330	OR 53.34x5.33-N70
53,56	3,53	4,8	1	60,35	54,64	53,90	59,61	227	OR 53.56x3.53-N70
53,64	2,62	3,6	0,8	58,73	54,54	53,98	58,17	138	OR 53.64x2.62-N70
53,97	3,53	4,8	1	60,74	55,02	54,29	60,01	–	OR 53.97x3.53-N70
54,2	5,7	7,5	1	65	55,3	55,00	65	–	OR 54.2x5.7-N70
54,5	3	3,7	1	60	55,2	–	–	–	OR 54.5x3.0-N70
55,25	2,62	3,6	0,8	60,33	56,14	55,58	59,77	139	OR 55.25x2.62-N70
55,56	3,53	4,8	1	62,34	56,62	55,88	61,6	–	OR 55.56x3.53-N70
56,52	5,33	7,1	1	66,7	57,94	57,07	65,83	331	OR 56.52x5.33-N70
56,74	3,53	4,8	1	63,92	57,81	57,07	62,79	228	OR 56.74x3.53-N70
56,82	2,62	3,6	0,8	61,9	57,71	57,15	61,34	140	OR 56.82x2.62-N70
57,15	3,53	4,8	1	63,92	58,22	57,47	63,19	–	OR 57.15x3.53-N70
58,42	2,62	3,6	0,8	63,5	59,31	58,73	62,92	141	OR 58.42x2.62-N70
58,74	3,53	4,8	1	65,5	59,78	59,05	64,77	–	OR 58.74x3.53-N70
59,2	5,7	7,5	1	70	60,3	60,00	70	–	OR 59.2x5.7-N70
59,5	3	3,7	1	65	60,2	–	–	–	OR 59.5x3.0-N70
59,69	5,33	7,1	1	69,88	61,12	60,25	69,01	332	OR 59.69x5.33-N70
59,92	3,53	4,8	1	66,7	60,99	60,25	65,96	229	OR 59.92x3.53-N70
60	2,62	3,6	0,8	65,1	60,91	60,33	64,52	142	OR 60.0x2.62-N70
60,33	3,53	4,8	1	67,09	61,37	60,66	66,38	–	OR 60.33x3.53-N70
61,6	2,62	3,6	0,8	66,68	62,49	61,90	66,09	143	OR 61.6x2.62-N70
61,91	3,53	4,8	1	68,68	62,96	62,23	67,95	–	OR 61.91x3.53-N70

6.1 OR O-rings in static radial sealing, metric sizes

ID 62,87 – 97,79 mm

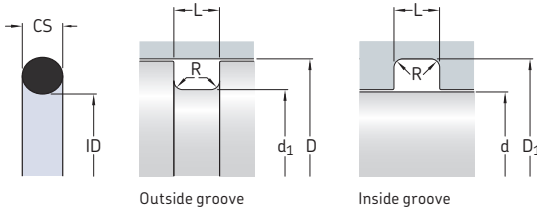

SKF recommends designing O-ring housings according to ISO 3601.
This table is a reference to O-ring sizes for common housing dimensions.

Dimensions				Outside groove		Inside groove		Dash-number	Designation
ID	CS	L +0,2	R max.	D H9	d ₁ h11	d f8	D ₁ H11		
mm								-	-
62,87	5,33	7,1	1	73,05	64,29	63,42	72,18	333	OR 62.87x5.33-N70
63,09	3,53	4,8	1	69,88	64,16	63,42	69,14	230	OR 63.09x3.53-N70
63,17	2,62	3,6	0,8	68,28	64,09	63,50	67,69	144	OR 63.17x2.62-N70
63,5	3,53	4,8	1	70,27	64,55	63,82	69,54	-	OR 63.5x3.53-N70
64,2	5,7	7,5	1	75	65,3	65,00	75	-	OR 64.2x5.7-N70
64,5	3	3,7	1	70	65,2	-	-	-	OR 64.5x3.0-N70
64,77	2,62	3,6	0,8	69,85	65,66	65,08	69,27	145	OR 64.77x2.62-N70
65,09	3,53	4,8	1	71,85	66,13	65,40	71,12	-	OR 65.09x3.53-N70
66,04	5,33	7,1	1	76,23	67,47	66,60	75,36	334	OR 66.04x5.33-N70
66,27	3,53	4,8	1	73,05	67,34	66,60	72,31	231	OR 66.27x3.53-N70
66,34	2,62	3,6	0,8	71,43	67,24	66,68	70,87	146	OR 66.34x2.62-N70
66,68	3,53	4,8	1	73,45	67,75	67,00	72,72	-	OR 66.68x3.53-N70
67,94	2,62	3,6	0,8	73,03	68,84	68,28	72,47	-	OR 67.94x2.62-N70
68,26	3,53	4,8	1	75,02	69,3	68,58	74,3	-	OR 68.26x3.53-N70
69,2	5,7	7,5	1	80	70,3	70,00	80	-	OR 69.2x5.7-N70
69,22	5,33	7,1	1	79,4	70,64	69,77	78,53	335	OR 69.22x5.33-N70
69,44	3,53	4,8	1	76,23	70,51	69,77	75,49	232	OR 69.44x3.53-N70
69,5	3	3,7	1	75	70,2	70,00	74,8	-	OR 69.5x3.0-N70
69,52	2,62	3,6	0,8	74,6	70,41	69,85	74,04	148	OR 69.52x2.62-N70
69,85	3,53	4,8	1	76,62	70,9	70,17	75,89	-	OR 69.85x3.53-N70

Dimensions				Outside groove		Inside groove		Dash-number	Designation
ID	CS	L +0,2	R max.	D H9	d ₁ h11	d f8	D ₁ H11		
mm									
71,12	2,62	3,6	0,8	76,6	72,01	71,43	75,62	149	OR 71.12x2.62-N70
71,44	3,53	4,8	1	78,2	72,48	71,75	77,47	–	OR 71.44x3.53-N70
72,39	5,33	7,1	1	82,58	73,82	72,95	81,71	336	OR 72.39x5.33-N70
72,62	3,53	4,8	1	79,4	73,69	72,95	78,66	233	OR 72.62x3.53-N70
73,02	3,53	4,8	1	79,79	74,04	73,34	79,06	–	OR 73.02x3.53-N70
74,2	5,7	7,5	1	85	75,3	75,00	85	–	OR 74.2x5.7-N70
74,5	3	3,7	1	80	75,2	75,00	79,8	–	OR 74.5x3.0-N70
74,6	3,53	4,8	1	81,38	75,66	74,93	80,65	–	OR 74.60x3.53-N70
74,63	5,33	7,1	1	85	76,24	75,35	84,11	–	OR 74.63x5.33-N70
75,57	5,33	7,1	1	85,78	77,02	76,10	84,86	337	OR 75.57x5.33-N70
75,79	3,53	4,8	1	82,58	76,86	76,10	81,81	234	OR 75.79x3.53-N70
78,74	5,33	7,1	1	88,95	80,19	79,27	88,03	338	OR 78.74x5.33-N70
78,97	3,53	4,8	1	85,78	80,06	79,27	84,99	235	OR 78.97x3.53-N70
79,2	5,7	7,5	1	90	80,3	80,00	90	–	OR 79.2x5.7-N70
79,5	3	3,7	1	85	80,2	80,00	84,8	–	OR 79.5x3.0-N70
79,73	5,33	7,1	1	90,93	82,17	81,29	90,05	–	OR 79.73x5.33-N70
81,92	5,33	7,1	1	92,13	83,37	82,45	91,21	339	OR 81.92x5.33-N70
82,14	3,53	4,8	1	88,95	83,23	82,45	88,16	236	OR 82.14x3.53-N70
84,1	5,7	7,5	1	95	85,3	85,00	95	–	OR 84.1x5.7-N70
84,5	3	3,7	1	90	85,2	85,00	89,8	–	OR 84.5x3.0-N70
85,09	5,33	7,1	1	95,3	86,54	85,62	94,38	340	OR 85.09x5.33-N70
85,32	3,53	4,8	1	92,13	86,41	85,62	91,34	237	OR 85.32x3.53-N70
88,27	5,33	7,1	1	98,48	89,72	88,80	97,56	341	OR 88.27x5.33-N70
88,49	3,53	4,8	1	95,09	89,37	88,80	94,51	238	OR 88.49x3.53-N70
89,1	5,7	7,5	1	100	90,3	90,00	100	–	OR 89.1x5.7-N70
89,5	3	3,7	1	95	90,2	90,00	94,8	–	OR 89.5x3.0-N70
89,69	5,33	7,1	1	100,06	91,3	90,40	99,16	–	OR 89.69x5.33-N70
91,44	5,33	7,1	1	101,65	92,89	91,97	100,73	342	OR 91.44x5.33-N70
91,67	3,53	4,8	1	98,48	92,76	91,97	97,69	239	OR 91.67x3.53-N70
94,1	5,7	7,5	1	105	95,3	95,00	105	–	OR 94.1x5.7-N70
94,5	3	3,7	1	100	95,2	95,00	99,8	–	OR 94.5x3.0-N70
94,62	5,33	7,1	1	104,83	96,07	95,15	103,91	343	OR 94.62x5.33-N70
94,84	3,53	4,8	1	–	–	95,15	100,86	240	OR 94.84x3.53-N70
97,79	5,33	7,1	1	108	99,24	98,32	107,08	344	OR 97.79x5.33-N70

6.1

6.1 OR O-rings in static radial sealing, metric sizes

ID 98,02 – 120 mm

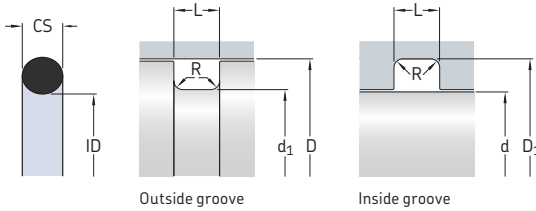

SKF recommends designing O-ring housings according to ISO 3601.
This table is a reference to O-ring sizes for common housing dimensions.

Dimensions				Outside groove		Inside groove		Dash-number	Designation
ID	CS	L +0,2	R max.	D H9	d ₁ h11	d f8	D ₁ H11		
mm								-	-
98,02	3,53	4,8	1	-	-	98,32	104,04	241	OR 98.02x3.53-N70
99,1	5,7	7,5	1	110	100,3	100,00	110	-	OR 99.1x5.7-N70
99,5	3	3,7	1	105	100,2	100,00	104,8	-	OR 99.5x3.0-N70
100	5,33	7,1	1	110,38	101,62	100,74	109,5	-	OR 100.0x5.33-N70
100,97	5,33	7,1	1	111,18	102,48	101,50	110,26	345	OR 100.97x5.33-N70
101,19	3,53	4,8	1	-	-	101,50	107,21	242	OR 101.19x3.53-N70
104,1	5,7	7,5	1	115	105,3	105,00	115	-	OR 104.1x5.7-N70
104,14	5,33	7,1	1	114,35	105,54	104,67	113,43	346	OR 104.14x5.33-N70
104,37	3,53	4,8	1	-	-	104,67	110,39	243	OR 104.37x3.53-N70
104,5	3	3,7	1	110	105,2	105,00	109,8	-	OR 104.5x3.0-N70
107,32	5,33	7,1	1	117,53	108,77	107,85	116,61	347	OR 107.32x5.33-N70
107,54	3,53	4,8	1	-	-	107,85	113,56	244	OR 107.54x3.53-N70
109,1	5,7	7,5	1	120	110,3	110,00	120	-	OR 109.1x5.7-N70
	3	3,7	1	115	110,2	110,00	114,8	-	OR 109.5x3.0-N70
109,5	5,33	7,1	1	119,91	111,15	110,23	118,99	-	OR 109.5x5.33-N70
110,49	5,33	7,1	1	120,7	111,94	111,05	119,81	348	OR 110.49x5.33-N70
110,72	3,53	4,8	1	-	-	111,02	116,74	245	OR 110.72x3.53-N70
113,67	5,33	7,1	1	123,88	115,12	114,20	122,96	349	OR 113.67x5.33-N70
113,7	6,99	9,5	1,5	127,1	115,95	114,20	125,35	425	OR 113.7x6.99-N70
113,89	3,53	4,8	1	-	-	114,20	119,91	246	OR 113.89x3.53-N70
114,3	5,7	7,5	1	125	115,3	115,00	125	-	OR 114.3x5.7-N70

Dimensions				Outside groove		Inside groove		Dash-number	Designation
ID	CS	L +0,2	R max.	D H9	d ₁ h11	d f8	D ₁ H11		
mm									
114,5	3	3,7	1	120	115,2	115,00	119,8	–	OR 114.5x3.0-N70
114,7	6,99	9,5	1,5	128,3	117,15	115,20	126,35	–	OR 114.7x6.99-N70
116,8	6,99	9,5	1,5	130,2	119,05	117,30	128,45	426	OR 116.8x6.99-N70
117,07	3,53	4,8	1	–	–	117,37	123,09	247	OR 117.07x3.53-N70
117,5	5,33	7,1	1	127,84	119,08	118,17	126,93	–	OR 117.5x5.33-N70
119,3	5,7	7,5	1	130	120,3	120,00	130	–	OR 119.3x5.7-N70
119,5	3	3,7	1	125	120,2	120,00	124,8	–	OR 119.5x3.0-N70
120	6,99	9,5	1,5	133,4	122,25	120,50	131,65	427	OR 120.0x6.99-N70

6.1 OR O-rings in static radial sealing, metric sizes

ID 120,24 – 164,3 mm

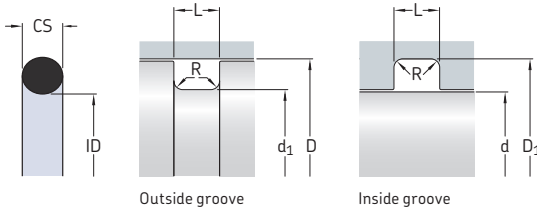

SKF recommends designing O-ring housings according to ISO 3601.
This table is a reference to O-ring sizes for common housing dimensions.

Dimensions				Outside groove		Inside groove		Dash-number	Designation
ID	CS	L +0,2	R max.	D H8	d ₁ h11	d f7	D ₁ H11		
mm								-	-
120,24	3,53	4,8	1	-	-	120,55	126,26	248	OR 120.24x3.53-N70
120,7	5,33	7,1	1	131,02	122,26	121,34	130,1	-	OR 120.7x5.33-N70
123,19	6,99	9,5	1,5	136,6	125,45	123,70	134,85	428	OR 123.19x6.99-N70
123,42	3,53	4,8	1	-	-	123,72	129,44	249	OR 123.42x3.53-N70
123,8	5,33	7,1	1	134,19	125,43	124,12	132,88	-	OR 123.8x5.33-N70
124,3	5,7	6,4	1	135	125,3	125,00	134,7	-	OR 124.3x5.7-N70
124,5	3	3,7	1	130	125,2	125,00	129,8	-	OR 124.5x3.0-N70
124,6	6,99	9,5	1,5	138,2	127,05	125,10	136,25	-	OR 124.60x6.99-N70
126,37	6,99	9,5	1,5	139,8	128,65	126,90	138,05	429	OR 126.37x6.99-N70
126,59	3,53	4,8	1	-	-	126,90	132,61	250	OR 126.59x3.53-N70
127	5,33	7,1	1	137,37	128,61	127,69	136,45	-	OR 127.0x5.33-N70
129,3	5,7	7,5	1	140	130,3	130,00	140	-	OR 129.3x5.7-N70
129,5	3	3,7	1	135	130,2	130,00	134,8	-	OR 129.5x3.0-N70
129,54	6,99	9,5	1,5	142,9	131,75	130,00	141,15	-	OR 129.54x6.99-N70
129,77	3,53	4,8	1	-	-	130,07	135,79	251	OR 129.77x3.53-N70
130,2	5,33	7,1	1	140,54	131,78	130,87	139,63	-	OR 130.2x5.33-N70
132,7	6,99	9,5	1,5	146,1	134,95	133,20	144,35	431	OR 132.7x6.99-N70
132,94	3,53	4,8	1	-	-	133,25	138,96	252	OR 132.94x3.53-N70
133,4	5,33	7,1	1	143,72	134,96	134,04	142,8	-	OR 133.4x5.33-N70
134,3	5,7	7,5	1	145	135,3	135,00	145	-	OR 134.3x5.7-N70
134,5	3	3,7	1	140	135,2	135,00	139,8	-	OR 134.5x3.0-N70
	6,99	9,5	1,5	148,2	137,05	135,00	146,15	-	OR 134.5x6.99-N70

Dimensions				Outside groove		Inside groove		Dash-number	Designation
ID	CS	L +0,2	R max.	D H8	d ₁ h11	d f7	D ₁ H11		
mm									
135,9	6,99	9,5	1,5	149,3	138,15	138,15	149,3	432	OR 135.9x6.99-N70
136,12	3,53	4,8	1	–	–	136,42	142,14	253	OR 136.12x3.53-N70
136,5	5,33	7,1	1	146,89	138,13	137,22	145,98	–	OR 136.5x5.33-N70
139,07	6,99	9,5	1,5	152,5	141,35	141,35	152,5	433	OR 139.07x6.99-N70
139,29	3,53	4,8	1	–	–	139,60	145,31	254	OR 139.29x3.53-N70
139,3	5,7	7,5	1	150	140,3	140,00	150	–	OR 139.3x5.7-N70
139,5	3	3,7	1	145	140,2	140,00	144,8	–	OR 139.5x3.0-N70
139,7	5,33	7,1	1	150,07	141,31	140,39	149,15	–	OR 139.7x5.33-N70
142,24	6,99	9,5	1,5	155,6	144,45	144,45	155,6	434	OR 142.24x6.99-N70
142,47	3,53	4,8	1	–	–	142,77	148,49	255	OR 142.47x3.53-N70
142,88	5,33	7,1	1	153,24	144,48	143,57	152,33	–	OR 142.88x5.33-N70
144,1	8,4	11	1	160	145	145,00	160	–	OR 144.1x8.4-N70
144,3	5,7	7,5	1	155	145,3	145,00	155	–	OR 144.3x5.7-N70
144,5	3	3,7	1	150	145,2	145,00	149,8	–	OR 144.5x3.0-N70
145,4	6,99	9,5	1,5	158,8	147,65	147,65	158,8	435	OR 145.4x6.99-N70
145,64	3,53	4,8	1	–	–	145,95	151,66	256	OR 145.64x3.53-N70
146,1	5,33	7,1	1	156,42	147,66	146,74	155,5	–	OR 146.1x5.33-N70
148,6	6,99	9,5	1,5	162	150,85	150,85	162	436	OR 148.6x6.99-N70
148,82	3,53	4,8	1	–	–	149,12	154,84	257	OR 148.82x3.53-N70
149,1	8,4	11	1	165	150	150,00	165	–	OR 149.1x8.4-N70
149,2	5,33	7,1	1	159,59	150,83	149,92	158,68	–	OR 149.2x5.33-N70
149,3	5,7	6,4	1	160	150,4	150,00	159,6	–	OR 149.3x5.7-N70
151,8	6,99	9,5	1,5	165,2	154,05	154,05	165,2	437	OR 151.8x6.99-N70
151,99	3,53	4,8	1	–	–	152,30	158,01	258	OR 151.99x3.53-N70
154,1	8,4	11	1	170	155	155,00	170	–	OR 154.1x8.4-N70
154,3	5,7	6,4	1	165	155,4	155,00	164,6	–	OR 154.3x5.7-N70
155,6	6,99	9,5	1,5	169	157,85	157,85	169	–	OR 155.6x6.99-N70
158,12	6,99	9,5	1,5	171,5	160,35	160,35	171,5	438	OR 158.12x6.99-N70
158,34	3,53	4,8	1	–	–	158,65	164,36	259	OR 158.34x3.53-N70
159,1	8,4	11	1	175	160	160,00	175	–	OR 159.1x8.4-N70
159,3	5,7	6,4	1	170	160,4	160,00	169,6	–	OR 159.3x5.7-N70
159,5	6,99	9,5	1,5	173	161,85	161,85	173	–	OR 159.5x6.99-N70
161,9	6,99	9,5	1,5	175,3	164,15	164,15	175,3	–	OR 161.9x6.99-N70
164,1	8,4	11	1	180	165	165,00	180	–	OR 164.1x8.4-N70
164,3	5,7	6,4	1	175	165,4	165,00	174,6	–	OR 164.3x5.7-N70

6.1 OR O-rings in static radial sealing, metric sizes

ID 164,47 – 240,89 mm

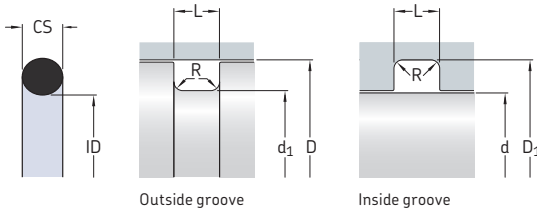

SKF recommends designing O-ring housings according to ISO 3601.
This table is a reference to O-ring sizes for common housing dimensions.

Dimensions				Outside groove		Inside groove		Dash-number	Designation
ID	CS	L +0,2	R max.	D H8	d ₁ h11	d f7	D ₁ H11		
mm								-	-
164,47	6,99	9,5	1,5	177,9	166,75	166,75	177,9	439	OR 164.47x6.99-N70
164,69	3,53	4,8	1	-	-	165,00	170,71	260	OR 164.69x3.53-N70
166,7	6,99	9,5	1,5	180,2	169,05	169,05	180,2	-	OR 166.7x6.99-N70
168,3	6,99	9,5	1,5	181,8	170,65	170,65	181,8	-	OR 168.3x6.99-N70
169,1	8,4	11	1	185	170	170,00	185	-	OR 169.1x8.4-N70
169,3	5,7	6,4	1	180	170,4	170,00	179,6	-	OR 169.3x5.7-N70
170,8	6,99	9,5	1,5	184,2	173,05	173,05	184,2	440	OR 170.8x6.99-N70
171,04	3,53	4,8	1	-	-	171,35	177,06	261	OR 171.04x3.53-N70
174,1	8,4	9	1	190	175	175,00	190	-	OR 174.1x8.4-N70
174,3	5,7	6,4	1	185	175,4	175,00	184,6	-	OR 174.3x5.7-N70
174,6	6,99	9,5	1,5	188,2	177,05	177,05	188,2	-	OR 174.6x6.99-N70
177,17	6,99	9,5	1,5	190,6	179,45	179,45	190,6	441	OR 177.17x6.99-N70
177,39	3,53	4,8	1	-	-	177,70	183,41	262	OR 177.39x3.53-N70
179,1	8,4	9	1	195	180	180,00	195	-	OR 179.1x8.4-N70
179,3	5,7	6,4	1	190	180,4	180,00	189,6	-	OR 179.3x5.7-N70
181	6,99	9,5	1,5	194,5	183,35	183,35	194,5	-	OR 181.0x6.99-N70
183,5	6,99	9,5	1,5	196,9	185,75	185,75	196,9	442	OR 183.5x6.99-N70
183,74	3,53	4,8	1	-	-	184,05	189,76	263	OR 183.74x3.53-N70
184,1	8,4	9	1	200	185	185,00	200	-	OR 184.1x8.4-N70
184,3	5,7	6,4	1	195	185,4	185,00	194,6	-	OR 184.3x5.7-N70
187,3	6,99	9,5	1,5	200,9	189,75	189,75	200,9	-	OR 187.3x6.99-N70

Dimensions				Outside groove		Inside groove		Dash-number	Designation
ID	CS	L +0,2	R max.	D H8	d ₁ h11	d f7	D ₁ H11		
mm									
189,1	8,4	9	1	205	190	190,00	205	–	OR 189.1x8.4-N70
189,3	5,7	6,4	1	200	190,4	190,00	199,6	–	OR 189.3x5.7-N70
189,9	6,99	9,5	1,5	203,3	192,15	192,15	203,3	443	OR 189.9x6.99-N70
190,09	3,53	4,8	1	–	–	190,40	196,11	264	OR 190.09x3.53-N70
193,7	6,99	9,5	1,5	207,2	196,05	196,05	207,2	–	OR 193.7x6.99-N70
194,1	8,4	9	1	210	195	195,00	210	–	OR 194.1x8.4-N70
194,3	5,7	6,4	1	205	195,4	195,00	204,6	–	OR 194.3x5.7-N70
196,2	6,99	9,5	1,5	209,6	198,45	198,45	209,6	444	OR 196.2x6.99-N70
196,44	3,53	4,8	1	–	–	196,75	202,46	265	OR 196.44x3.53-N70
199,1	8,4	9	1	215	200	200,00	215	–	OR 199.1x8.4-N70
199,3	5,7	6,4	1	210	200,4	200,00	209,6	–	OR 199.3x5.7-N70
200	6,99	9,5	1,5	213,6	202,45	202,45	213,6	–	OR 200.0x6.99-N70
202,57	6,99	9,5	1,5	216	204,85	204,85	216	445	OR 202.57x6.99-N70
202,79	3,53	4,8	1	–	–	203,10	208,81	266	OR 202.79x3.53-N70
208,9	6,99	9,5	1,5	222,3	211,15	211,15	222,3	–	OR 208.9x6.99-N70
209,1	8,4	9	1	225	210	210,00	225	–	OR 209.1x8.4-N70
209,14	3,53	4,8	1	–	–	209,45	215,16	267	OR 209.14x3.53-N70
209,3	5,7	6,4	1	220	210,4	210,00	219,6	–	OR 209.3x5.7-N70
215,3	6,99	9,5	1,5	228,7	217,55	217,55	228,7	446	OR 215.3x6.99-N70
215,49	3,53	4,8	1	–	–	215,80	221,51	268	OR 215.49x3.53-N70
219,1	8,4	9	1	235	220	220,00	235	–	OR 219.1x8.4-N70
219,3	5,7	6,4	1	230	220,4	220,00	229,6	–	OR 219.3x5.7-N70
221,62	6,99	9,5	1,5	235	223,85	223,82	235	–	OR 221.62x6.99-N70
221,84	3,53	4,8	1	–	–	222,15	227,86	269	OR 221.84x3.53-N70
227,97	6,99	9,5	1,5	241,4	230,25	230,25	241,4	447	OR 227.97x6.99-N70
228,19	3,53	4,8	1	–	–	228,50	234,21	270	OR 228.19x3.53-N70
229,1	8,4	9	1	245	230	230,00	245	–	OR 229.1x8.4-N70
229,3	5,7	6,4	1	240	230,4	230,00	239,6	–	OR 229.3x5.7-N70
234,3	6,99	9,5	1,5	247,7	236,55	236,55	247,7	–	OR 234.3x6.99-N70
234,54	3,53	4,8	1	–	–	234,85	240,56	271	OR 234.54x3.53-N70
239,1	8,4	9	1	255	240	240,00	255	–	OR 239.1x8.4-N70
239,3	5,7	6,4	1	250	240,4	240,00	249,6	–	OR 239.3x5.7-N70
240,67	6,99	9,5	1,5	254,1	242,95	242,95	254,1	448	OR 240.67x6.99-N70
240,89	3,53	4,8	1	–	–	241,20	246,91	272	OR 240.89x3.53-N70

6.1 OR O-rings in static radial sealing, metric sizes

ID 247 – 499,3 mm

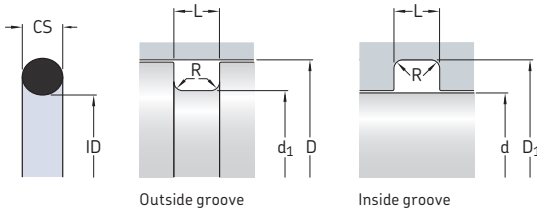

SKF recommends designing O-ring housings according to ISO 3601.
This table is a reference to O-ring sizes for common housing dimensions.

Dimensions				Outside groove		Inside groove		Dash-number	Designation
ID	CS	L +0,2	R max.	D H8	d ₁ h11	d f7	D ₁ H11		
mm								-	-
247	6,99	9,5	1,5	260,4	249,25	249,25	260,4	-	OR 247.0x6.99-N70
247,25	3,53	4,8	1	-	-	247,55	253,26	273	OR 247.25x3.53-N70
249,1	8,4	9	1	265	250	250,00	265	-	OR 249.1x8.4-N70
249,3	5,7	6,4	1	260	250,4	250,00	259,6	-	OR 249.3x5.7-N70
253,3	6,99	9,5	1,5	266,8	255,65	255,65	266,8	449	OR 253.3x6.99-N70
253,59	3,53	4,8	1	-	-	253,90	259,61	274	OR 253.59x3.53-N70
259,3	5,7	6,4	1	270	260,4	260,00	269,6	-	OR 259.3x5.7-N70
259,7	6,99	9,5	1,5	273,1	261,95	261,95	273,1	-	OR 259.7x6.99-N70
266,07	6,99	9,5	1,5	279,5	268,35	268,35	279,5	450	OR 266.07x6.99-N70
269,3	5,7	6,4	1	280	270,4	270,00	279,6	-	OR 269.3x5.7-N70
272,4	6,99	9,5	1,5	285,8	274,65	274,65	285,8	-	OR 272.4x6.99-N70
278,77	6,99	9,5	1,5	292,2	281,05	281,05	292,2	451	OR 278.77x6.99-N70
279,3	5,7	6,4	1	290	280,4	280,00	289,6	-	OR 279.3x5.7-N70
285,1	6,99	9,5	1,5	298,5	287,35	287,35	298,5	-	OR 285.1x6.99-N70
289,3	5,7	6,4	1	300	290,4	290,00	299,6	-	OR 289.3x5.7-N70
291,47	6,99	9,5	1,5	304,9	293,75	293,75	304,9	452	OR 291.47x6.99-N70
297,8	6,99	9,5	1,5	311,2	300,05	300,05	311,2	-	OR 297.8x6.99-N70
299,3	5,7	6,4	1	310	300,4	300,00	309,6	-	OR 299.3x5.7-N70
304,1	6,99	9,5	1,5	317,6	306,45	306,45	317,6	453	OR 304.1x6.99-N70
316,9	6,99	9,5	1,5	330,3	319,15	319,15	330,3	454	OR 316.9x6.99-N70
319,3	5,7	6,4	1	330	320,4	320,00	329,6	-	OR 319.3x5.7-N70

Dimensions				Outside groove		Inside groove		Dash-number	Designation
ID	CS	L +0,2	R max.	D H8	d ₁ h11	d f7	D ₁ H11		
mm									
329,5	6,99	9,5	1,5	343	331,85	331,85	343	455	OR 329.5x6.99-N70
339,3	5,7	6,4	1	350	340,4	340,00	349,6	–	OR 339.3x5.7-N70
342,27	6,99	9,5	1,5	355,7	344,55	344,55	355,7	456	OR 342.27x6.99-N70
355	6,99	9,5	1,5	368,4	357,25	357,25	368,4	457	OR 355.0x6.99-N70
359,3	5,7	6,4	1	370	360,4	360,00	369,6	–	OR 359.3x5.7-N70
367,7	6,99	9,5	1,5	381,1	369,95	369,95	381,1	458	OR 367.7x6.99-N70
379,3	5,7	6,4	1	390	380,4	380,00	389,6	–	OR 379.3x5.7-N70
380,37	6,99	9,5	1,5	393,8	382,65	382,65	393,8	459	OR 380.37x6.99-N70
393,1	6,99	9,5	1,5	406,5	395,35	395,35	406,5	460	OR 393.1x6.99-N70
399,3	5,7	6,4	1	410	400,4	400,00	409,6	–	OR 399.3x5.7-N70
419,3	5,7	6,4	1	430	420,4	420,00	429,6	–	OR 419.3x5.7-N70
439,3	5,7	6,4	1	450	440,4	440,00	449,6	–	OR 439.3x5.7-N70
459,3	5,7	6,4	1	470	460,4	460,00	469,6	–	OR 459.3x5.7-N70
479,3	5,7	6,4	1	490	480,4	480,00	489,6	–	OR 479.3x5.7-N70
499,3	5,7	6,4	1	510	500,4	500,00	509,6	–	OR 499.3x5.7-N70

Other sizes are available on request

6.2 OR O-rings in static radial sealing, inch sizes

Dash-number 004 – 155

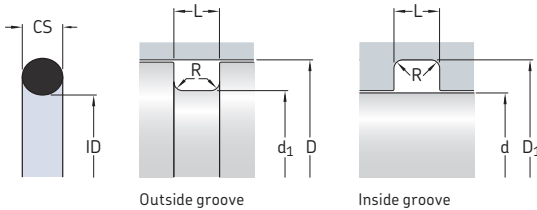

SKF recommends designing O-ring housings according to ISO 3601.
This table is a reference to O-ring sizes for common housing dimensions.

Dash-number	Dimensions				Outside groove		Inside groove		Designation
	CS	ID	L +0.008	R max.	D +0.002	d ₁ -0.002	d -0.002	D ₁ +0.002	
-	in.								-
004	0,07	0,07	0,093	0,02	0,206	0,106	0,081	0,181	OR 1.78x1.78-N70
005	0,07	0,101	0,093	0,02	0,237	0,137	0,112	0,212	OR 2.57x1.78-N70
006	0,07	0,114	0,093	0,02	0,25	0,15	0,125	0,225	OR 2.90x1.78-N70
007	0,07	0,145	0,093	0,02	0,281	0,181	0,156	0,256	OR 3.69x1.78-N70
008	0,07	0,176	0,093	0,02	0,312	0,212	0,187	0,287	OR 4.48x1.78-N70
009	0,07	0,208	0,093	0,02	0,343	0,243	0,218	0,318	OR 5.28x1.78-N70
010	0,07	0,239	0,093	0,02	0,375	0,275	0,25	0,35	OR 6.07x1.78-N70
011	0,07	0,301	0,093	0,02	0,437	0,337	0,312	0,412	OR 7.65x1.78-N70
012	0,07	0,364	0,093	0,02	0,5	0,4	0,375	0,475	OR 9.25x1.78-N70
013	0,07	0,426	0,093	0,02	0,562	0,462	0,437	0,537	OR 10.82x1.78-N70
014	0,07	0,489	0,093	0,02	0,625	0,525	0,5	0,6	OR 12.42x1.78-N70
015	0,07	0,551	0,093	0,02	0,687	0,587	0,562	0,662	OR 14.0x1.78-N70
016	0,07	0,614	0,093	0,02	0,75	0,65	0,625	0,725	OR 15.6x1.78-N70
017	0,07	0,676	0,093	0,02	0,812	0,712	0,687	0,787	OR 17.17x1.78-N70
018	0,07	0,739	0,093	0,02	0,875	0,775	0,75	0,85	OR 18.77x1.78-N70
019	0,07	0,801	0,093	0,02	0,937	0,837	0,812	0,912	OR 20.35x1.78-N70
020	0,07	0,864	0,093	0,02	1	0,9	0,875	0,975	OR 21.95x1.78-N70
021	0,07	0,926	0,093	0,02	1,062	0,962	0,937	1,037	OR 23.52x1.78-N70
022	0,07	0,989	0,093	0,02	1,125	1,025	1	1,1	OR 25.12x1.78-N70
023	0,07	1,051	0,093	0,02	1,187	1,087	1,062	1,162	OR 26.7x1.78-N70
024	0,07	1,114	0,093	0,02	1,25	1,15	1,125	1,225	OR 28.3x1.78-N70
025	0,07	1,176	0,093	0,02	1,312	1,212	1,187	1,287	OR 29.87x1.78-N70
026	0,07	1,239	0,093	0,02	1,375	1,275	1,25	1,35	OR 31.47x1.78-N70
027	0,07	1,301	0,093	0,02	1,437	1,337	1,312	1,412	OR 33.05x1.78-N70
028	0,07	1,364	0,093	0,02	1,5	1,4	1,375	1,475	OR 34.65x1.78-N70
029	0,07	1,429	0,093	0,02	1,625	1,525	1,5	1,6	OR 37.82x1.78-N70
030	0,07	1,614	0,093	0,02	1,75	1,65	1,625	1,725	OR 41.0x1.78-N70
031	0,07	1,739	0,093	0,02	1,875	1,775	1,75	1,85	OR 44.17x1.78-N70
032	0,07	1,864	0,093	0,02	2	1,9	1,875	1,975	OR 47.35x1.78-N70
033	0,07	1,989	0,093	0,02	2,125	2,025	2	2,1	OR 50.52x1.78-N70
034	0,07	2,114	0,093	0,02	2,25	2,15	2,125	2,225	OR 53.7x1.78-N70
035	0,07	2,239	0,093	0,02	2,375	2,275	2,25	2,35	OR 56.87x1.78-N70
036	0,07	2,364	0,093	0,02	2,5	2,4	2,375	2,475	OR 60.04x1.78-N70
037	0,07	2,489	0,093	0,02	2,625	2,525	2,5	2,6	OR 63.22x1.78-N70
038	0,07	2,614	0,093	0,02	2,75	2,65	2,625	2,725	OR 66.4x1.78-N70
039	0,07	2,739	0,093	0,02	2,875	2,775	2,75	2,85	OR 69.57x1.78-N70

Dash-number	Dimensions				Outside groove		Inside groove		Designation	
	CS	ID	L +0.008	R max.	D +0.002	d ₁ -0.002	d -0.002	D ₁ +0.002		
										in.
-	in.									-
040	0,07	2,864	0,093	0,02	3	2,9	2,875	2,975	OR 72.75x1.78-N70	
041	0,07	2,989	0,093	0,02	3,125	3,025	3	3,1	OR 75.92x1.78-N70	
042	0,07	3,239	0,093	0,02	3,375	3,275	3,25	3,35	OR 82.27x1.78-N70	
043	0,07	3,489	0,093	0,02	3,625	3,525	3,5	3,6	OR 88.62x1.78-N70	
044	0,07	3,739	0,093	0,02	3,875	3,775	3,75	3,85	OR 94.97x1.78-N70	
045	0,07	3,99	0,093	0,02	4,125	4,025	4	4,1	OR 101.34x1.78-N70	
046	0,07	4,239	0,093	0,02	4,375	4,275	4,25	4,35	OR 107.67x1.78-N70	
047	0,07	4,489	0,093	0,02	4,625	4,525	4,5	4,6	OR 114.02x1.78-N70	
048	0,07	4,739	0,093	0,02	4,875	4,775	4,75	4,85	OR 120.37x1.78-N70	
049	0,07	4,989	0,093	0,02	5,125	5,025	5	5,1	OR 126.72x1.78-N70	
050	0,07	5,239	0,093	0,02	5,375	5,275	5,25	5,35	OR 133.07x1.78-N70	
106	0,103	0,174	0,14	0,03	0,374	0,212	0,187	0,349	OR 4.42x2.62-N70	
107	0,103	0,206	0,14	0,03	0,405	0,243	0,219	0,381	OR 5.23x2.62-N70	
109	0,103	0,299	0,14	0,03	0,5	0,338	0,312	0,474	OR 7.59x2.62-N70	
110	0,103	0,362	0,14	0,03	0,562	0,4	0,375	0,537	OR 9.19x2.62-N70	
111	0,103	0,424	0,14	0,03	0,625	0,463	0,437	0,599	OR 10.78x2.62-N70	
112	0,103	0,487	0,14	0,03	0,687	0,525	0,5	0,662	OR 12.37x2.62-N70	
113	0,103	0,549	0,14	0,03	0,75	0,588	0,563	0,725	OR 13.94x2.62-N70	
114	0,103	0,612	0,14	0,03	0,812	0,65	0,625	0,787	OR 15.54x2.62-N70	
115	0,103	0,674	0,14	0,03	0,875	0,713	0,688	0,85	OR 17.12x2.62-N70	
116	0,103	0,737	0,14	0,03	0,937	0,775	0,75	0,912	OR 18.72x2.62-N70	
117	0,103	0,799	0,14	0,03	1	0,838	0,813	0,975	OR 20.29x2.62-N70	
118	0,103	0,862	0,14	0,03	1,062	0,9	0,875	1,037	OR 21.89x2.62-N70	
119	0,103	0,924	0,14	0,03	1,125	0,963	0,938	1,1	OR 23.47x2.62-N70	
120	0,103	0,987	0,14	0,03	1,187	1,025	1	1,162	OR 25.07x2.62-N70	
121	0,103	1,049	0,14	0,03	1,25	1,088	1,062	1,224	OR 26.64x2.62-N70	
123	0,103	1,174	0,14	0,03	1,375	1,213	1,187	1,349	OR 29.82x2.62-N70	
124	0,103	1,237	0,14	0,03	1,437	1,275	1,25	1,412	OR 31.42x2.62-N70	
125	0,103	1,299	0,14	0,03	1,5	1,338	1,312	1,474	OR 32.99x2.62-N70	
126	0,103	1,362	0,14	0,03	1,562	1,4	1,375	1,537	OR 34.59x2.62-N70	
127	0,103	1,424	0,14	0,03	1,625	1,463	1,437	1,599	OR 36.17x2.62-N70	
128	0,103	1,487	0,14	0,03	1,687	1,525	1,5	1,662	OR 37.77x2.62-N70	
129	0,103	1,549	0,14	0,03	1,75	1,588	1,562	1,724	OR 39.34x2.62-N70	
130	0,103	1,612	0,14	0,03	1,812	1,65	1,625	1,787	OR 40.95x2.62-N70	
131	0,103	1,674	0,14	0,03	1,875	1,713	1,687	1,849	OR 42.52x2.62-N70	
132	0,103	1,737	0,14	0,03	1,937	1,775	1,75	1,912	OR 44.12x2.62-N70	
133	0,103	1,799	0,14	0,03	2	1,838	1,812	1,974	OR 45.69x2.62-N70	
134	0,103	1,862	0,14	0,03	2,062	1,9	1,875	2,037	OR 47.29x2.62-N70	
135	0,103	1,925	0,14	0,03	2,125	1,963	1,937	2,099	OR 48.9x2.62-N70	
136	0,103	1,987	0,14	0,03	2,187	2,025	2	2,162	OR 50.47x2.62-N70	
137	0,103	2,05	0,14	0,03	2,25	2,088	2,062	2,224	OR 52.07x2.62-N70	
138	0,103	2,112	0,14	0,03	2,312	2,15	2,125	2,287	OR 53.64x2.62-N70	
139	0,103	2,175	0,14	0,03	2,375	2,213	2,187	2,349	OR 55.25x2.62-N70	
140	0,103	2,237	0,14	0,03	2,437	2,275	2,25	2,412	OR 56.82x2.62-N70	
141	0,103	2,3	0,14	0,03	2,5	2,338	2,312	2,474	OR 58.42x2.62-N70	
142	0,103	2,362	0,14	0,03	2,562	2,4	2,375	2,537	OR 60.0x2.62-N70	
143	0,103	2,425	0,14	0,03	2,625	2,463	2,437	2,599	OR 61.6x2.62-N70	
144	0,103	2,487	0,14	0,03	2,687	2,525	2,5	2,662	OR 63.17x2.62-N70	
145	0,103	2,55	0,14	0,03	2,75	2,588	2,562	2,724	OR 64.77x2.62-N70	
146	0,103	2,612	0,14	0,03	2,812	2,65	2,625	2,787	OR 66.34x2.62-N70	
147	0,103	2,675	0,14	0,03	2,875	2,713	2,687	2,849	OR 67.94x2.62-N70	
148	0,103	2,737	0,14	0,03	2,937	2,775	2,75	2,912	OR 69.52x2.62-N70	
149	0,103	2,8	0,14	0,03	3	2,838	2,812	2,974	OR 71.12x2.62-N70	
150	0,103	2,862	0,14	0,03	3,062	2,9	2,937	3,099	OR 72.7x2.62-N70	
151	0,103	2,987	0,14	0,03	3,187	3,025	3	3,162	OR 75.87x2.62-N70	
152	0,103	3,237	0,14	0,03	3,437	3,275	3,25	3,412	OR 82.22x2.62-N70	
153	0,103	3,487	0,14	0,03	3,687	3,525	3,5	3,662	OR 88.57x2.62-N70	
154	0,103	3,737	0,14	0,03	3,937	3,775	3,75	3,912	OR 94.92x2.62-N70	
155	0,103	3,987	0,14	0,03	4,187	4,025	4	4,162	OR 101.27x2.62-N70	

6.2

6.2 OR O-rings in static radial sealing, inch sizes

Dash-number 156 – 274

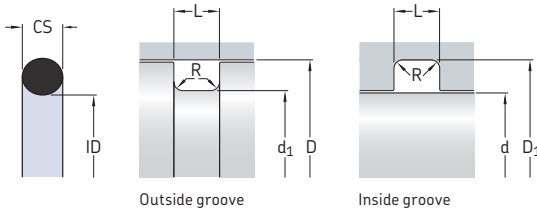

SKF recommends designing O-ring housings according to ISO 3601.
This table is a reference to O-ring sizes for common housing dimensions.

Dash-number	Dimensions				Outside groove		Inside groove		Designation
	CS	ID	L +0.008	R max.	D +0.002	d ₁ -0.002	d -0.002	D ₁ +0.002	
-	in.								-
156	0,103	4,237	0,14	0,03	4,437	4,275	4,25	4,412	OR 107.62x2.62-N70
157	0,103	4,487	0,14	0,03	4,687	4,525	4,5	4,662	OR 113.97x2.62-N70
158	0,103	4,737	0,14	0,03	4,937	4,775	4,75	4,912	OR 120.32x2.62-N70
159	0,103	4,987	0,14	0,03	5,187	5,025	5	5,162	OR 126.67x2.62-N70
160	0,103	5,237	0,14	0,03	5,437	5,275	5,25	5,412	OR 133.02x2.62-N70
161	0,103	5,487	0,14	0,03	5,687	5,525	5,5	5,662	OR 139.37x2.62-N70
162	0,103	5,737	0,14	0,03	5,937	5,775	5,75	5,912	OR 145.72x2.62-N70
163	0,103	5,987	0,14	0,03	6,187	6,025	6	6,162	OR 152.07x2.62-N70
164	0,103	6,237	0,14	0,03	6,437	6,275	6,25	6,412	OR 158.42x2.62-N70
165	0,103	6,487	0,14	0,03	6,687	6,525	6,5	6,662	OR 164.77x2.62-N70
166	0,103	6,737	0,14	0,03	6,937	6,775	6,75	6,912	OR 171.12x2.62-N70
167	0,103	6,987	0,14	0,03	7,187	7,025	7	7,162	OR 177.47x2.62-N70
168	0,103	7,237	0,14	0,03	7,437	7,275	7,25	7,412	OR 183.82x2.62-N70
169	0,103	7,487	0,14	0,03	7,687	7,525	7,5	7,662	OR 190.17x2.62-N70
170	0,103	7,737	0,14	0,03	7,937	7,775	7,75	7,912	OR 196.52x2.62-N70
171	0,103	7,987	0,14	0,03	8,187	8,025	8	8,162	OR 202.87x2.62-N70
172	0,103	8,237	0,14	0,03	8,437	8,275	8,25	8,412	OR 209.22x2.62-N70
173	0,103	8,487	0,14	0,03	8,687	8,525	8,5	8,662	OR 215.57x2.62-N70
174	0,103	8,737	0,14	0,03	8,937	8,775	8,75	8,912	OR 221.92x2.62-N70
175	0,103	8,987	0,14	0,03	9,187	9,025	9	9,162	OR 228.27x2.62-N70
176	0,103	9,237	0,14	0,03	9,437	9,275	9,25	9,412	OR 234.62x2.62-N70
177	0,103	9,487	0,14	0,03	9,687	9,525	9,5	9,662	OR 240.97x2.62-N70
178	0,103	9,737	0,14	0,03	9,937	9,775	9,75	9,912	OR 247.32x2.62-N70
205	0,139	0,421	0,187	0,04	0,687	0,465	0,437	0,659	OR 10.69x3.53-N70
206	0,139	0,484	0,187	0,04	0,75	0,528	0,5	0,722	OR 12.29x3.53-N70
207	0,139	0,546	0,187	0,04	0,812	0,59	0,562	0,784	OR 13.87x3.53-N70
208	0,139	0,609	0,187	0,04	0,875	0,653	0,625	0,847	OR 15.47x3.53-N70
209	0,139	0,671	0,187	0,04	0,937	0,715	0,687	0,909	OR 17.04x3.53-N70
210	0,139	0,734	0,187	0,04	1	0,778	0,75	0,972	OR 18.64x3.53-N70
211	0,139	0,796	0,187	0,04	1,062	0,84	0,812	1,034	OR 20.22x3.53-N70
212	0,139	0,859	0,187	0,04	1,125	0,903	0,875	1,097	OR 21.82x3.53-N70
213	0,139	0,921	0,187	0,04	1,187	0,965	0,937	1,159	OR 23.4x3.53-N70
214	0,139	0,984	0,187	0,04	1,25	1,028	1	1,222	OR 24.99x3.53-N70
215	0,139	1,046	0,187	0,04	1,312	1,09	1,062	1,284	OR 26.58x3.53-N70
216	0,139	1,109	0,187	0,04	1,375	1,153	1,125	1,347	OR 28.17x3.53-N70

Dash-number	Dimensions				Outside groove		Inside groove		Designation
	CS	ID	L +0.008	R max.	D +0.002	d ₁ -0.002	d -0.002	D ₁ +0.002	
217	0,139	1,171	0,187	0,04	1,437	1,215	1,187	1,409	OR 29.74x3.53-N70
218	0,139	1,234	0,187	0,04	1,5	1,278	1,25	1,472	OR 31.34x3.53-N70
219	0,139	1,296	0,187	0,04	1,562	1,34	1,312	1,534	OR 32.92x3.53-N70
220	0,139	1,359	0,187	0,04	1,625	1,403	1,375	1,597	OR 34.52x3.53-N70
221	0,139	1,421	0,187	0,04	1,687	1,465	1,437	1,659	OR 36.1x3.53-N70
222	0,139	1,484	0,187	0,04	1,75	1,528	1,5	1,722	OR 37.69x3.53-N70
223	0,139	1,609	0,187	0,04	1,875	1,653	1,625	1,847	OR 40.87x3.53-N70
224	0,139	1,734	0,187	0,04	2	1,778	1,75	1,972	OR 44.04x3.53-N70
225	0,139	1,859	0,187	0,04	2,125	1,903	1,875	2,097	OR 47.22x3.53-N70
226	0,139	1,984	0,187	0,04	2,25	2,028	2	2,222	OR 50.4x3.53-N70
227	0,139	2,109	0,187	0,04	2,375	2,153	2,125	2,347	OR 53.56x3.53-N70
228	0,139	2,234	0,187	0,04	2,5	2,278	2,25	2,472	OR 56.74x3.53-N70
229	0,139	2,359	0,187	0,04	2,625	2,403	2,375	2,597	OR 59.92x3.53-N70
230	0,139	2,484	0,187	0,04	2,75	2,528	2,5	2,722	OR 63.09x3.53-N70
231	0,139	2,609	0,187	0,04	2,875	2,653	2,625	2,847	OR 66.27x3.53-N70
232	0,139	2,734	0,187	0,04	3	2,778	2,75	2,972	OR 69.44x3.53-N70
233	0,139	2,859	0,187	0,04	3,125	2,903	2,875	3,097	OR 72.62x3.53-N70
234	0,139	2,984	0,187	0,04	3,25	3,028	3	3,222	OR 75.79x3.53-N70
235	0,139	3,109	0,187	0,04	3,375	3,153	3,125	3,347	OR 78.97x3.53-N70
236	0,139	3,234	0,187	0,04	3,5	3,278	3,25	3,472	OR 82.14x3.53-N70
237	0,139	3,359	0,187	0,04	3,625	3,403	3,375	3,597	OR 85.32x3.53-N70
238	0,139	3,484	0,187	0,04	3,75	3,528	3,5	3,722	OR 88.49x3.53-N70
239	0,139	3,609	0,187	0,04	3,875	3,653	3,625	3,847	OR 91.67x3.53-N70
240	0,139	3,734	0,187	0,04	4	3,778	3,75	3,972	OR 94.84x3.53-N70
241	0,139	3,859	0,187	0,04	4,125	3,903	3,875	4,097	OR 98.02x3.53-N70
242	0,139	3,984	0,187	0,04	4,25	4,028	4	4,222	OR 101.19x3.53-N70
243	0,139	4,109	0,187	0,04	4,375	4,153	4,125	4,347	OR 104.37x3.53-N70
244	0,139	4,234	0,187	0,04	4,5	4,278	4,25	4,472	OR 107.54x3.53-N70
245	0,139	4,359	0,187	0,04	4,625	4,403	4,375	4,597	OR 110.72x3.53-N70
246	0,139	4,484	0,187	0,04	4,75	4,528	4,5	4,722	OR 113.89x3.53-N70
247	0,139	4,609	0,187	0,04	4,875	4,653	4,625	4,847	OR 117.07x3.53-N70
248	0,139	4,734	0,187	0,04	5	4,778	4,75	4,972	OR 120.24x3.53-N70
249	0,139	4,859	0,187	0,04	5,125	4,903	4,875	5,097	OR 123.42x3.53-N70
250	0,139	4,984	0,187	0,04	5,25	5,028	5	5,222	OR 126.59x3.53-N70
251	0,139	5,109	0,187	0,04	5,375	5,153	5,125	5,347	OR 129.77x3.53-N70
252	0,139	5,234	0,187	0,04	5,5	5,278	5,25	5,472	OR 132.94x3.53-N70
253	0,139	5,359	0,187	0,04	5,625	5,403	5,375	5,597	OR 136.12x3.53-N70
254	0,139	5,484	0,187	0,04	5,75	5,528	5,5	5,722	OR 139.29x3.53-N70
255	0,139	5,609	0,187	0,04	5,875	5,653	5,625	5,847	OR 142.47x3.53-N70
256	0,139	5,734	0,187	0,04	6	5,778	5,75	5,972	OR 145.64x3.53-N70
257	0,139	5,859	0,187	0,04	6,125	5,903	5,875	6,097	OR 148.82x3.53-N70
258	0,139	5,984	0,187	0,04	6,25	6,028	6	6,222	OR 151.99x3.53-N70
259	0,139	6,234	0,187	0,04	6,5	6,278	6,25	6,472	OR 158.34x3.53-N70
260	0,139	6,484	0,187	0,04	6,75	6,528	6,5	6,722	OR 164.69x3.53-N70
261	0,139	6,734	0,187	0,04	7	6,778	6,75	6,972	OR 171.04x3.53-N70
262	0,139	6,984	0,187	0,04	7,25	7,028	7	7,222	OR 177.39x3.53-N70
263	0,139	7,234	0,187	0,04	7,5	7,278	7,25	7,472	OR 183.74x3.53-N70
264	0,139	7,484	0,187	0,04	7,75	7,528	7,5	7,722	OR 190.09x3.53-N70
265	0,139	7,734	0,187	0,04	8	7,778	7,75	7,972	OR 196.44x3.53-N70
266	0,139	7,984	0,187	0,04	8,25	8,028	8	8,222	OR 202.79x3.53-N70
267	0,139	8,234	0,187	0,04	8,5	8,278	8,25	8,472	OR 209.14x3.53-N70
268	0,139	8,484	0,187	0,04	8,75	8,528	8,5	8,722	OR 215.49x3.53-N70
269	0,139	8,734	0,187	0,04	9	8,778	8,75	8,972	OR 221.84x3.53-N70
270	0,139	8,984	0,187	0,04	9,25	9,028	9	9,222	OR 228.19x3.53-N70
271	0,139	9,234	0,187	0,04	9,5	9,278	9,25	9,472	OR 234.54x3.53-N70
272	0,139	9,484	0,187	0,04	9,75	9,528	9,5	9,722	OR 240.89x3.53-N70
273	0,139	9,734	0,187	0,04	10	9,778	9,75	9,972	OR 247.25x3.53-N70
274	0,139	9,984	0,187	0,04	10,25	10,028	10	10,222	OR 253.59x3.53-N70

6.2 OR O-rings in static radial sealing, inch sizes

Dash-number 275 – 374

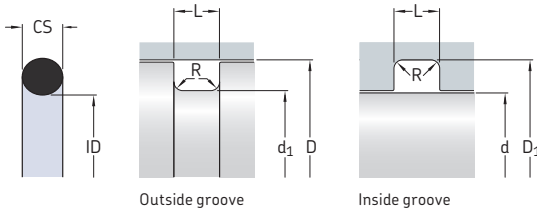

SKF recommends designing O-ring housings according to ISO 3601.
This table is a reference to O-ring sizes for common housing dimensions.

Dash-number	Dimensions				Outside groove		Inside groove		Designation
	CS	ID	L +0.008	R max.	D +0.002	d ₁ -0.002	d -0.002	D ₁ +0.002	
–	in.								–
275	0,139	10,484	0,187	0,04	10,75	10,528	10,5	10,722	OR 266.29x3.53-N70
276	0,139	10,984	0,187	0,04	11,25	11,028	11	11,222	OR 279.0x3.53-N70
277	0,139	11,484	0,187	0,04	11,75	11,528	11,5	11,722	OR 291.69x3.53-N70
278	0,139	11,984	0,187	0,04	12,25	12,028	12	12,222	OR 304.39x3.53-N70
279	0,139	12,984	0,187	0,04	13,25	13,028	13	13,222	OR 329.79x3.53-N70
280	0,139	13,984	0,187	0,04	14,25	14,028	14	14,222	OR 355.19x3.53-N70
281	0,139	14,984	0,187	0,04	15,25	15,028	15	15,222	OR 380.59x3.53-N70
282	0,139	15,955	0,187	0,04	16,25	16,028	16	16,222	OR 405.26x3.53-N70
283	0,139	16,955	0,187	0,04	17,25	17,028	17	17,222	OR 430.66x3.53-N70
284	0,139	17,955	0,187	0,04	18,25	18,028	18	18,222	OR 456.06x3.53-N70

Dash-number	Dimensions				Outside groove		Inside groove		Designation
	CS	ID	L +0.008	R max.	D +0.004	d ₁ -0.004	d -0.002	D ₁ +0.004	
314	0,21	0,725	0,281	0,04	1,125	0,785	0,75	1,09	OR 18.42x5.33-N70
316	0,21	0,85	0,281	0,04	1,25	0,91	0,875	1,215	OR 21.59x5.33-N70
317	0,21	0,912	0,281	0,04	1,312	0,972	0,937	1,277	OR 23.16x5.33-N70
318	0,21	0,975	0,281	0,04	1,375	1,035	1	1,34	OR 24.77x5.33-N70
319	0,21	1,037	0,281	0,04	1,437	1,097	1,062	1,402	OR 26.34x5.33-N70
320	0,21	1,1	0,281	0,04	1,5	1,16	1,125	1,465	OR 27.94x5.33-N70
321	0,21	1,162	0,281	0,04	1,562	1,222	1,187	1,527	OR 29.51x5.33-N70
322	0,21	1,225	0,281	0,04	1,625	1,285	1,25	1,59	OR 31.12x5.33-N70
323	0,21	1,287	0,281	0,04	1,687	1,347	1,312	1,652	OR 32.69x5.33-N70
324	0,21	1,35	0,281	0,04	1,75	1,41	1,375	1,715	OR 34.29x5.33-N70
325	0,21	1,475	0,281	0,04	1,875	1,535	1,5	1,84	OR 37.47x5.33-N70
326	0,21	1,6	0,281	0,04	2	1,66	1,625	1,965	OR 40.65x5.33-N70
327	0,21	1,725	0,281	0,04	2,125	1,785	1,75	2,09	OR 43.82x5.33-N70
328	0,21	1,85	0,281	0,04	2,25	1,91	1,875	2,215	OR 46.99x5.33-N70
329	0,21	1,975	0,281	0,04	2,375	2,035	2	2,34	OR 50.16x5.33-N70
330	0,21	2,1	0,281	0,04	2,5	2,16	2,125	2,465	OR 53.34x5.33-N70
331	0,21	2,225	0,281	0,04	2,625	2,285	2,25	2,59	OR 56.52x5.33-N70
332	0,21	2,35	0,281	0,04	2,75	2,41	2,375	2,715	OR 59.69x5.33-N70
333	0,21	2,475	0,281	0,04	2,875	2,535	2,5	2,84	OR 62.87x5.33-N70
334	0,21	2,6	0,281	0,04	3	2,66	2,625	2,965	OR 66.04x5.33-N70
335	0,21	2,725	0,281	0,04	3,125	2,785	2,75	3,09	OR 69.22x5.33-N70
336	0,21	2,85	0,281	0,04	3,25	2,91	2,875	3,215	OR 72.39x5.33-N70
337	0,21	2,975	0,281	0,04	3,375	3,035	3	3,34	OR 75.57x5.33-N70
338	0,21	3,1	0,281	0,04	3,5	3,16	3,125	3,465	OR 78.74x5.33-N70
339	0,21	3,225	0,281	0,04	3,625	3,285	3,25	3,59	OR 81.92x5.33-N70
340	0,21	3,35	0,281	0,04	3,75	3,41	3,375	3,715	OR 85.09x5.33-N70
341	0,21	3,475	0,281	0,04	3,875	3,535	3,5	3,84	OR 88.27x5.33-N70
342	0,21	3,6	0,281	0,04	4	3,66	3,625	3,965	OR 91.44x5.33-N70
343	0,21	3,725	0,281	0,04	4,125	3,785	3,75	4,09	OR 94.62x5.33-N70
344	0,21	3,85	0,281	0,04	4,25	3,91	3,875	4,215	OR 97.79x5.33-N70
345	0,21	3,975	0,281	0,04	4,375	4,035	4	4,34	OR 100.97x5.33-N70
346	0,21	4,1	0,281	0,04	4,5	4,16	4,125	4,465	OR 104.14x5.33-N70
347	0,21	4,225	0,281	0,04	4,625	4,285	4,25	4,59	OR 107.32x5.33-N70
348	0,21	4,35	0,281	0,04	4,75	4,41	4,375	4,715	OR 110.49x5.33-N70
349	0,21	4,475	0,281	0,04	4,875	4,535	4,5	4,84	OR 113.67x5.33-N70
350	0,21	4,6	0,281	0,04	5	4,66	4,625	4,965	OR 116.84x5.33-N70
351	0,21	4,725	0,281	0,04	5,125	4,785	4,75	5,09	OR 120.02x5.33-N70
352	0,21	4,85	0,281	0,04	5,25	4,91	4,875	5,215	OR 123.19x5.33-N70
353	0,21	4,975	0,281	0,04	5,375	5,035	5	5,34	OR 126.37x5.33-N70
354	0,21	5,1	0,281	0,04	5,5	5,16	5,125	5,465	OR 129.54x5.33-N70
355	0,21	5,225	0,281	0,04	5,625	5,285	5,25	5,59	OR 132.72x5.33-N70
356	0,21	5,35	0,281	0,04	5,75	5,41	5,375	5,715	OR 135.89x5.33-N70
357	0,21	5,475	0,281	0,04	5,875	5,535	5,5	5,84	OR 139.07x5.33-N70
358	0,21	5,6	0,281	0,04	6	5,66	5,625	5,965	OR 142.24x5.33-N70
359	0,21	5,725	0,281	0,04	6,125	5,785	5,75	6,09	OR 145.42x5.33-N70
360	0,21	5,85	0,281	0,04	6,25	5,91	5,875	6,215	OR 148.59x5.33-N70
361	0,21	5,975	0,281	0,04	6,375	6,035	6	6,34	OR 151.77x5.33-N70
362	0,21	6,225	0,281	0,04	6,625	6,285	6,25	6,59	OR 158.12x5.33-N70
363	0,21	6,475	0,281	0,04	6,875	6,535	6,5	6,84	OR 164.47x5.33-N70
364	0,21	6,725	0,281	0,04	7,125	6,785	6,75	7,09	OR 170.82x5.33-N70
365	0,21	6,975	0,281	0,04	7,375	7,035	7	7,34	OR 177.17x5.33-N70
366	0,21	7,225	0,281	0,04	7,625	7,285	7,25	7,59	OR 183.52x5.33-N70
367	0,21	7,475	0,281	0,04	7,875	7,535	7,5	7,84	OR 189.87x5.33-N70
368	0,21	7,725	0,281	0,04	8,125	7,785	7,75	8,09	OR 196.22x5.33-N70
369	0,21	7,975	0,281	0,04	8,375	8,035	8	8,34	OR 202.57x5.33-N70
370	0,21	8,225	0,281	0,04	8,625	8,285	8,25	8,59	OR 208.92x5.33-N70
371	0,21	8,475	0,281	0,04	8,875	8,535	8,5	8,84	OR 215.27x5.33-N70
372	0,21	8,725	0,281	0,04	9,125	8,785	8,75	9,09	OR 221.62x5.33-N70
373	0,21	8,975	0,281	0,04	9,375	9,035	9	9,34	OR 227.97x5.33-N70
374	0,21	9,225	0,281	0,04	9,625	9,285	9,25	9,59	OR 234.32x5.33-N70

6.2

6.2 OR O-rings in static radial sealing, inch sizes

Dash-number 375 – 475

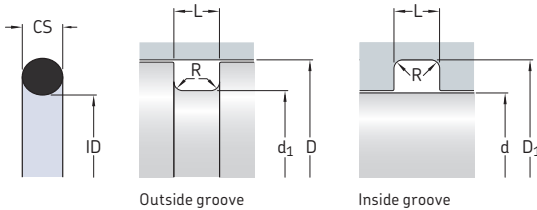

SKF recommends designing O-ring housings according to ISO 3601.
This table is a reference to O-ring sizes for common housing dimensions.

Dash-number	Dimensions				Outside groove		Inside groove		Designation
	CS	ID	L +0.008	R max.	D +0.004	d ₁ -0.004	d -0.002	D ₁ +0.004	
-	in.								-
375	0,21	9,475	0,281	0,04	9,875	9,535	9,5	9,84	OR 240.67x5.33-N70
376	0,21	9,725	0,281	0,04	10,125	9,785	9,75	10,09	OR 247.02x5.33-N70
377	0,21	9,975	0,281	0,04	10,375	10,035	10	10,34	OR 253.37x5.33-N70
378	0,21	10,475	0,281	0,04	10,875	10,535	10,5	10,84	OR 266.07x5.33-N70
379	0,21	10,975	0,281	0,04	11,375	11,035	11	11,34	OR 278.77x5.33-N70
380	0,21	11,475	0,281	0,04	11,875	11,535	11,5	11,84	OR 291.47x5.33-N70
381	0,21	11,975	0,281	0,04	12,375	12,035	12	12,34	OR 304.17x5.33-N70
382	0,21	12,975	0,281	0,04	13,375	13,035	13	13,34	OR 329.57x5.33-N70
383	0,21	13,975	0,281	0,04	14,375	14,035	14	14,34	OR 354.97x5.33-N70
384	0,21	14,975	0,281	0,04	15,375	15,035	15	15,34	OR 380.37x5.33-N70
385	0,21	15,955	0,281	0,04	16,375	16,035	16	16,34	OR 405.26x5.33-N70
386	0,21	16,955	0,281	0,04	17,375	17,035	17	17,34	OR 430.66x5.33-N70
387	0,21	17,955	0,281	0,04	18,375	18,035	18	18,34	OR 456.06x5.33-N70
388	0,21	18,953	0,281	0,04	19,375	19,035	19	19,34	OR 481.41x5.33-N70
389	0,21	19,953	0,281	0,04	20,375	20,035	20	20,34	OR 506.81x5.33-N70
390	0,21	20,953	0,281	0,04	21,375	21,035	21	21,34	OR 532.21x5.33-N70
391	0,21	21,953	0,281	0,04	22,375	22,035	22	22,34	OR 557.61x5.33-N70
392	0,21	22,94	0,281	0,04	23,375	23,035	23	23,34	OR 582.68x5.33-N70
393	0,21	23,94	0,281	0,04	24,375	24,035	24	24,34	OR 608.08x5.33-N70
394	0,21	24,94	0,281	0,04	25,375	25,035	25	25,34	OR 633.48x5.33-N70
395	0,21	25,94	0,281	0,04	26,375	26,035	26	26,34	OR 658.88x5.33-N70
425	0,275	4,476	0,375	0,06	5	4,548	4,5	4,952	OR 113.7x6.99-N70
426	0,275	4,598	0,375	0,06	5,125	4,673	4,625	5,077	OR 116.8x6.99-N70
427	0,275	4,724	0,375	0,06	5,25	4,798	4,75	5,202	OR 120.0x6.99-N70
428	0,275	4,85	0,375	0,06	5,375	4,923	4,875	5,327	OR 123.19x6.99-N70
429	0,275	4,975	0,375	0,06	5,5	5,048	5	5,452	OR 126.37x6.99-N70
430	0,275	5,1	0,375	0,06	5,625	5,173	5,125	5,577	OR 129.54x6.99-N70
431	0,275	5,224	0,375	0,06	5,75	5,298	5,25	5,702	OR 132.7x6.99-N70
432	0,275	5,35	0,375	0,06	5,875	5,423	5,375	5,827	OR 135.9x6.99-N70
433	0,275	5,475	0,375	0,06	6	5,548	5,5	5,952	OR 139.07x6.99-N70
434	0,275	5,6	0,375	0,06	6,125	5,673	5,625	6,077	OR 142.24x6.99-N70
435	0,275	5,724	0,375	0,06	6,25	5,798	5,75	6,202	OR 145.4x6.99-N70
436	0,275	5,85	0,375	0,06	6,375	5,923	5,875	6,327	OR 148.6x6.99-N70

Dash-number	Dimensions				Outside groove		Inside groove		Designation
	CS	ID	L +0.008	R max.	D	d ₁	d	D ₁	
					+0.004	-0.004	-0.002	+0.004	
-	in.								-
437	0,275	5,976	0,375	0,06	6,5	6,048	6	6,452	OR 151.8x6.99-N70
438	0,275	6,225	0,375	0,06	6,75	6,298	6,25	6,702	OR 158.12x6.99-N70
439	0,275	6,475	0,375	0,06	7	6,548	6,5	6,952	OR 164.47x6.99-N70
440	0,275	6,724	0,375	0,06	7,25	6,798	6,75	7,202	OR 170.8x6.99-N70
441	0,275	6,975	0,375	0,06	7,5	7,048	7	7,452	OR 177.17x6.99-N70
442	0,275	7,224	0,375	0,06	7,75	7,298	7,25	7,702	OR 183.5x6.99-N70
443	0,275	7,476	0,375	0,06	8	7,548	7,5	7,952	OR 189.9x6.99-N70
444	0,275	7,724	0,375	0,06	8,25	7,798	7,75	8,202	OR 196.2x6.99-N70
445	0,275	7,975	0,375	0,06	8,5	8,048	8	8,452	OR 202.57x6.99-N70
446	0,275	8,476	0,375	0,06	9	8,548	8,5	8,952	OR 215.3x6.99-N70
447	0,275	8,975	0,375	0,06	9,5	9,048	9	9,452	OR 227.97x6.99-N70
448	0,275	9,475	0,375	0,06	10	9,548	9,5	9,952	OR 240.67x6.99-N70
449	0,275	9,972	0,375	0,06	10,5	10,048	10	10,452	OR 253.3x6.99-N70
450	0,275	10,475	0,375	0,06	11	10,548	10,5	10,952	OR 266.07x6.99-N70
451	0,275	10,975	0,375	0,06	11,5	11,048	11	11,452	OR 278.77x6.99-N70
452	0,275	11,475	0,375	0,06	12	11,548	11,5	10,952	OR 291.47x6.99-N70
453	0,275	11,972	0,375	0,06	12,5	12,048	12	12,452	OR 304.1x6.99-N70
454	0,275	12,476	0,375	0,06	13	12,548	12,5	12,952	OR 316.9x6.99-N70
455	0,275	12,972	0,375	0,06	13,5	13,048	13	13,452	OR 329.5x6.99-N70
456	0,275	13,475	0,375	0,06	14	13,548	13,5	13,952	OR 342.27x6.99-N70
457	0,275	13,976	0,375	0,06	14,5	14,048	14	14,452	OR 355.0x6.99-N70
458	0,275	14,476	0,375	0,06	15	14,548	14,5	14,952	OR 367.7x6.99-N70
459	0,275	14,975	0,375	0,06	15,5	15,048	15	15,452	OR 380.37x6.99-N70
460	0,275	15,476	0,375	0,06	16	15,548	15,5	15,952	OR 393.1x6.99-N70
461	0,275	15,955	0,375	0,06	16,5	16,048	16	16,452	OR 405.26x6.99-N70
462	0,275	16,455	0,375	0,06	17	16,548	16,5	16,952	OR 417.96x6.99-N70
463	0,275	16,955	0,375	0,06	17,5	17,048	17	17,452	OR 430.66x6.99-N70
464	0,275	17,455	0,375	0,06	18	17,548	17,5	17,952	OR 443.36x6.99-N70
465	0,275	17,955	0,375	0,06	18,5	18,048	18	18,452	OR 456.06x6.99-N70
466	0,275	18,455	0,375	0,06	19	18,548	18,5	18,952	OR 468.76x6.99-N70
467	0,275	18,955	0,375	0,06	19,5	19,048	19	19,452	OR 481.46x6.99-N70
468	0,275	19,455	0,375	0,06	20	19,548	19,5	19,952	OR 494.16x6.99-N70
469	0,275	19,955	0,375	0,06	20,5	20,048	20	20,452	OR 506.86x6.99-N70
470	0,275	20,955	0,375	0,06	21,5	21,048	21	21,452	OR 532.26x6.99-N70
471	0,275	21,955	0,375	0,06	22,5	22,048	22	22,452	OR 557.66x6.99-N70
472	0,275	22,94	0,375	0,06	23,5	23,048	23	23,452	OR 582.68x6.99-N70
473	0,275	23,94	0,375	0,06	24,5	24,048	24	24,452	OR 608.08x6.99-N70
474	0,275	24,94	0,375	0,06	25,5	25,048	25	25,452	OR 633.48x6.99-N70
475	0,275	25,94	0,375	0,06	26,5	26,048	26	26,452	OR 658.88x6.99-N70

Other sizes are available on request

6.3 STR Back-up rings in static radial sealing, metric sizes

ID 9,3 – 99,5 mm

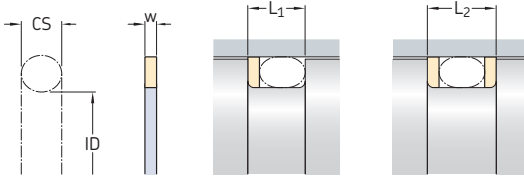

Back-up rings are selected by the corresponding O-ring dimensions.

Dimensions					Designation
ID	CS	w	L ₁ +0,2	L ₂ +0,2	
mm					-
9,3	2,4	1,3	4,6	6	STR 10x14x1.3-Y95A
10,3	2,4	1,3	4,6	6	STR 11x15x1.3-Y95A
11,3	2,4	1,3	4,6	6	STR 12x16x1.3-Y95A
12,3	2,4	1,3	4,6	6	STR 13x17x1.3-Y95A
13,3	2,4	1,3	4,6	6	STR 14x18x1.3-Y95A
14,3	2,4	1,3	4,6	6	STR 15x19x1.3-Y95A
15,3	2,4	1,3	4,6	6	STR 16x20x1.3-Y95A
17,3	2,4	1,3	4,6	6	STR 18x22x1.3-Y95A
18,3	2,4	1,3	4,6	6	STR 17x21x1.3-Y95A
19,2	3	1,3	5,4	6,8	STR 20x25x1.3-Y95A
21,2	3	1,3	5,4	6,8	STR 22x27x1.3-Y95A
22,2	3	1,3	5,4	6,8	STR 23x28x1.3-Y95A
24,2	3	1,3	5,4	6,8	STR 25x30x1.3-Y95A
26,2	3	1,3	5,4	6,8	STR 27x32x1.3-Y95A
29,2	3	1,3	5,4	6,8	STR 30x35x1.3-Y95A
31,2	3	1,3	5,4	6,8	STR 32x37x1.3-Y95A
32,2	3	1,3	5,4	6,8	STR 33x38x1.3-Y95A
34,2	3	1,3	5,4	6,8	STR 35x40x1.3-Y95A
35	3	1,3	5,4	6,8	STR 36x41x1.3-Y95A
36,2	3	1,3	5,4	6,8	STR 37x42x1.3-Y95A
39,2	3	1,3	5,4	6,8	STR 40x45x1.3-Y95A
	5,7	1,7	9,3	11,1	STR 40x50x1.7-Y95A

Dimensions					Designation
ID	CS	w	L ₁ +0,2	L ₂ +0,2	
mm					-
42,2	3	1,3	5,4	6,8	STR 43x48x1.3-Y95A
44,2	3	1,3	5,4	6,8	STR 45x50x1.3-Y95A
	5,7	1,7	9,3	11,1	STR 45x55x1.7-Y95A
49,2	5,7	1,7	9,3	11,1	STR 50x60x1.7-Y95A
49,5	3	1,3	5,4	6,8	STR 50x55x1.3-Y95A
52,3	5,7	1,7	9,3	11,1	STR 53x63x1.7-Y95A
54,2	5,7	1,7	9,3	11,1	STR 55x65x1.7-Y95A
54,5	3	1,3	5,4	6,8	STR 55x60x1.3-Y95A
56	3	1,3	5,4	6,8	STR 57x62x1.3-Y95A
57,5	3	1,3	5,4	6,8	STR 58x63x1.3-Y95A
59,2	5,7	1,7	9,3	11,1	STR 60x70x1.7-Y95A
59,5	3	1,3	5,4	6,8	STR 60x65x1.3-Y95A
62	3	1,3	5,4	6,8	STR 63x68x1.3-Y95A
64,2	5,7	1,7	9,3	11,1	STR 65x75x1.7-Y95A
64,5	3	1,3	5,4	6,8	STR 65x70x1.3-Y95A
67	3	1,3	5,4	6,8	STR 68x73x1.3-Y95A
68	3	1,3	5,4	6,8	STR 69x74x1.3-Y95A
69,2	5,7	1,7	9,3	11,1	STR 70x80x1.7-Y95A
69,5	3	1,3	5,4	6,8	STR 70x75x1.3-Y95A
74,2	5,7	1,7	9,3	11,1	STR 75x85x1.7-Y95A
74,5	3	1,3	5,4	6,8	STR 75x80x1.3-Y95A
75	3	1,3	5,4	6,8	STR 76x81x1.3-Y95A
78	3	1,3	5,4	6,8	STR 79x84x1.3-Y95A
79,2	5,7	1,7	9,3	11,1	STR 80x90x1.7-Y95A
79,5	3	1,3	5,4	6,8	STR 80x85x1.3-Y95A
84,1	5,7	1,7	9,3	11,1	STR 85x95x1.7-Y95A
84,5	3	1,3	5,4	6,8	STR 85x90x1.3-Y95A
87	3	1,3	5,4	6,8	STR 88x93x1.3-Y95A
89,1	5,7	1,7	9,3	11,1	STR 90x100x1.7-Y95A
89,5	3	1,3	5,4	6,8	STR 90x95x1.3-Y95A
94,1	5,7	1,7	9,3	11,1	STR 95x105x1.7-Y95A
94,5	3	1,3	5,4	6,8	STR 95x100x1.3-Y95A
98	3	1,3	5,4	6,8	STR 98x103x1.3-Y95A
99,1	5,7	1,7	9,3	11,1	STR 100x110x1.7-Y95A
99,5	3	1,3	5,4	6,8	STR 100x105x1.3-Y95A

6.3 STR Back-up rings in static radial sealing, metric sizes

ID 104,1 – 269,3 mm

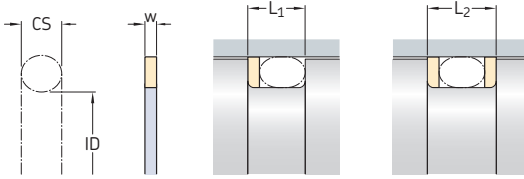

Back-up rings are selected by the corresponding O-ring dimensions.

Dimensions					Designation
ID	CS	w	L ₁ +0,2	L ₂ +0,2	
mm					-
104,1	5,7	1,7	9,3	11,1	STR 105x115x1.7-Y95A
104,5	3	1,3	5,4	6,8	STR 105x110x1.3-Y95A
109,1	5,7	1,7	9,3	11,1	STR 110x120x1.7-Y95A
109,5	3	1,3	5,4	6,8	STR 110x115x1.3-Y95A
114,3	5,7	1,7	9,3	11,1	STR 115x125x1.7-Y95A
114,5	3	1,3	5,4	6,8	STR 115x120x1.3-Y95A
119,3	5,7	1,7	9,3	11,1	STR 120x130x1.7-Y95A
119,5	3	1,3	5,4	6,8	STR 120x125x1.3-Y95A
124,3	5,7	1,7	9,3	11,1	STR 125x135x1.7-Y95A
124,5	3	1,3	5,4	6,8	STR 125x130x1.3-Y95A
129,3	5,7	1,7	9,3	11,1	STR 130x140x1.7-Y95A
129,5	3	1,3	5,4	6,8	STR 130x135x1.3-Y95A
134,3	5,7	1,7	9,3	11,1	STR 135x145x1.7-Y95A
134,5	3	1,3	5,4	6,8	STR 135x140x1.3-Y95A
139,3	5,7	1,7	9,3	11,1	STR 140x150x1.7-Y95A
139,5	3	1,3	5,4	6,8	STR 140x145x1.3-Y95A
144,3	5,7	1,7	9,3	11,1	STR 145x155x1.7-Y95A
144,5	3	1,3	5,4	6,8	STR 145x150x1.3-Y95A
149,3	5,7	1,7	9,3	11,1	STR 150x160x1.7-Y95A
154,3	5,7	1,7	9,3	11,1	STR 155x165x1.7-Y95A
154,5	3	1,3	5,4	6,8	STR 155x160x1.3-Y95A

Dimensions					Designation
ID	CS	w	L ₁ +0,2	L ₂ +0,2	
mm					-
159,3	5,7	1,7	9,3	11,1	STR 160x170x1.7-Y95A
164,3	5,7	1,7	9,3	11,1	STR 165x175x1.7-Y95A
169,3	5,7	1,7	9,3	11,1	STR 170x180x1.7-Y95A
174	3	1,3	5,4	6,8	STR 175x180x1.3-Y95A
174,3	5,7	1,7	9,3	11,1	STR 175x185x1.7-Y95A
179,3	5,7	1,7	9,3	11,1	STR 180x190x1.7-Y95A
184,3	5,7	1,7	9,3	11,1	STR 185x195x1.7-Y95A
189,3	5,7	1,7	9,3	11,1	STR 190x200x1.7-Y95A
194,3	5,7	1,7	9,3	11,1	STR 195x205x1.7-Y95A
199,3	5,7	1,7	9,3	11,1	STR 200x210x1.7-Y95A
209,3	5,7	1,7	9,3	11,1	STR 210x220x1.7-Y95A
219,3	5,7	1,7	9,3	11,1	STR 220x230x1.7-Y95A
229,3	5,7	1,7	9,3	11,1	STR 230x240x1.7-Y95A
239,3	5,7	1,7	9,3	11,1	STR 240x250x1.7-Y95A
244,3	5,7	1,7	9,3	11,1	STR 245x255x1.7-Y95A
249,3	5,7	1,7	9,3	11,1	STR 250x260x1.7-Y95A
269,3	5,7	1,7	9,3	11,1	STR 270x280x1.7-Y95A

Other sizes are available on request

6.4 STR Back-up rings in static radial sealing, inch sizes by dash-number, metric dimensions

Dash-number **013 – 128**

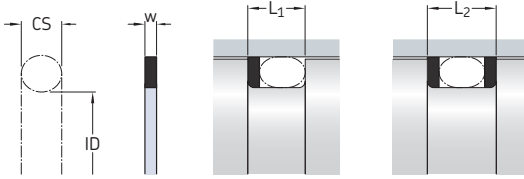

Back-up rings are selected by the corresponding O-ring dimensions.

Dash-number	Dimensions					Designation
	ID	CS	w	L ₁ +0,2	L ₂ +0,2	
-	mm					-
013	10,82	1,78	1,1	3,8	5,2	STR 19-013-395A
014	12,42	1,78	1,1	3,8	5,2	STR 19-014-395A
015	14	1,78	1,1	3,8	5,2	STR 19-015-395A
016	15,6	1,78	1,1	3,8	5,2	STR 19-016-395A
017	17,17	1,78	1,1	3,8	5,2	STR 19-017-395A
018	18,77	1,78	1,1	3,8	5,2	STR 19-018-395A
019	20,35	1,78	1,1	3,8	5,2	STR 19-019-395A
020	21,95	1,78	1,1	3,8	5,2	STR 19-020-395A
021	23,52	1,78	1,1	3,8	5,2	STR 19-021-395A
022	25,12	1,78	1,1	3,8	5,2	STR 19-022-395A
023	26,7	1,78	1,1	3,8	5,2	STR 19-023-395A
024	28,3	1,78	1,1	3,8	5,2	STR 19-024-395A
025	29,87	1,78	1,1	3,8	5,2	STR 19-025-395A
026	31,47	1,78	1,1	3,8	5,2	STR 19-026-395A
027	33,05	1,78	1,1	3,8	5,2	STR 19-027-395A
028	34,65	1,78	1,1	3,8	5,2	STR 19-028-395A
029	37,62	1,78	1,1	3,8	5,2	STR 19-029-395A
030	41	1,78	1,1	3,8	5,2	STR 19-030-395A
031	44,17	1,78	1,1	3,8	5,2	STR 19-031-395A
032	47,35	1,78	1,1	3,8	5,2	STR 19-032-395A
033	50,52	1,78	1,1	3,8	5,2	STR 19-033-395A

Dash-number	Dimensions					Designation
	ID	CS	w	L ₁ +0,2	L ₂ +0,2	
-	mm					-
034	53,7	1,78	1,1	3,8	5,2	STR 19-034-395A
035	56,87	1,78	1,1	3,8	5,2	STR 19-035-395A
036	60,05	1,78	1,1	3,8	5,2	STR 19-036-395A
037	63,22	1,78	1,1	3,8	5,2	STR 19-037-395A
038	66,4	1,78	1,1	3,8	5,2	STR 19-038-395A
039	69,57	1,78	1,1	3,8	5,2	STR 19-039-395A
040	72,75	1,78	1,1	3,8	5,2	STR 19-040-395A
041	75,92	1,78	1,1	3,8	5,2	STR 19-041-395A
042	82,27	1,78	1,1	3,8	5,2	STR 19-042-395A
043	88,62	1,78	1,1	3,8	5,2	STR 19-043-395A
044	94,97	1,78	1,1	3,8	5,2	STR 19-044-395A
045	101,32	1,78	1,1	3,8	5,2	STR 19-045-395A
046	107,67	1,78	1,1	3,8	5,2	STR 19-046-395A
047	114,02	1,78	1,1	3,8	5,2	STR 19-047-395A
048	120,37	1,78	1,1	3,8	5,2	STR 19-048-395A
049	126,72	1,78	1,1	3,8	5,2	STR 19-049-395A
050	133,07	1,78	1,1	3,8	5,2	STR 19-050-395A
111	10,77	2,62	1,3	5	6,4	STR 19-111-395A
112	12,37	2,62	1,3	5	6,4	STR 19-112-395A
113	13,94	2,62	1,3	5	6,4	STR 19-113-395A
114	15,54	2,62	1,3	5	6,4	STR 19-114-395A
115	17,12	2,62	1,3	5	6,4	STR 19-115-395A
116	18,72	2,62	1,3	5	6,4	STR 19-116-395A
117	20,29	2,62	1,3	5	6,4	STR 19-117-395A
118	21,89	2,62	1,3	5	6,4	STR 19-118-395A
119	23,47	2,62	1,3	5	6,4	STR 19-119-395A
120	25,07	2,62	1,3	5	6,4	STR 19-120-395A
121	26,64	2,62	1,3	5	6,4	STR 19-121-395A
122	28,24	2,62	1,3	5	6,4	STR 19-122-395A
123	29,82	2,62	1,3	5	6,4	STR 19-123-395A
124	31,42	2,62	1,3	5	6,4	STR 19-124-395A
125	32,99	2,62	1,3	5	6,4	STR 19-125-395A
126	34,59	2,62	1,3	5	6,4	STR 19-126-395A
127	36,17	2,62	1,3	5	6,4	STR 19-127-395A
128	37,77	2,62	1,3	5	6,4	STR 19-128-395A

6.4 STR Back-up rings in static radial sealing, inch sizes by dash-number, metric dimensions

Dash-number 129 – 225

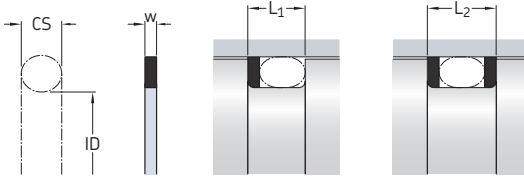

Back-up rings are selected by the corresponding O-ring dimensions.

Dash-number	Dimensions					Designation
	ID	CS	w	L ₁ +0,2	L ₂ +0,2	
–	mm					–
129	39,34	2,62	1,3	5	6,4	STR 19-129-395A
130	40,94	2,62	1,3	5	6,4	STR 19-130-395A
131	42,52	2,62	1,3	5	6,4	STR 19-131-395A
132	44,12	2,62	1,3	5	6,4	STR 19-132-395A
133	45,69	2,62	1,3	5	6,4	STR 19-133-395A
134	47,29	2,62	1,3	5	6,4	STR 19-134-395A
135	48,9	2,62	1,3	5	6,4	STR 19-135-395A
136	50,47	2,62	1,3	5	6,4	STR 19-136-395A
137	52,07	2,62	1,3	5	6,4	STR 19-137-395A
138	53,64	2,62	1,3	5	6,4	STR 19-138-395A
139	55,25	2,62	1,3	5	6,4	STR 19-139-395A
140	56,82	2,62	1,3	5	6,4	STR 19-140-395A
141	58,42	2,62	1,3	5	6,4	STR 19-141-395A
142	59,99	2,62	1,3	5	6,4	STR 19-142-395A
143	61,6	2,62	1,3	5	6,4	STR 19-143-395A
144	63,17	2,62	1,3	5	6,4	STR 19-144-395A
145	64,77	2,62	1,3	5	6,4	STR 19-145-395A
146	66,34	2,62	1,3	5	6,4	STR 19-146-395A
147	67,95	2,62	1,3	5	6,4	STR 19-147-395A
148	69,52	2,62	1,3	5	6,4	STR 19-148-395A
149	71,12	2,62	1,3	5	6,4	STR 19-149-395A

Dash-number	Dimensions					Designation
	ID	CS	w	L ₁ +0,2	L ₂ +0,2	
-	mm					-
150	72,69	2,62	1,3	5	6,4	STR 19-150-395A
151	75,87	2,62	1,3	5	6,4	STR 19-151-395A
152	82,22	2,62	1,3	5	6,4	STR 19-152-395A
153	88,57	2,62	1,3	5	6,4	STR 19-153-395A
154	94,92	2,62	1,3	5	6,4	STR 19-154-395A
155	101,27	2,62	1,3	5	6,4	STR 19-155-395A
158	120,32	2,62	1,3	5	6,4	STR 19-158-395A
159	126,67	2,62	1,3	5	6,4	STR 19-159-395A
160	133,02	2,62	1,3	5	6,4	STR 19-160-395A
161	139,37	2,62	1,3	5	6,4	STR 19-161-395A
162	145,72	2,62	1,3	5	6,4	STR 19-162-395A
163	152,07	2,62	1,3	5	6,4	STR 19-163-395A
167	177,47	2,62	1,3	5	6,4	STR 19-167-395A
205	10,69	3,53	1,5	6,2	7,6	STR 19-205-395A
206	12,29	3,53	1,5	6,2	7,6	STR 19-206-395A
207	13,87	3,53	1,5	6,2	7,6	STR 19-207-395A
208	15,47	3,53	1,5	6,2	7,6	STR 19-208-395A
209	17,04	3,53	1,5	6,2	7,6	STR 19-209-395A
210	18,64	3,53	1,5	6,2	7,6	STR 19-210-395A
211	20,22	3,53	1,5	6,2	7,6	STR 19-211-395A
212	21,82	3,53	1,5	6,2	7,6	STR 19-212-395A
213	23,39	3,53	1,5	6,2	7,6	STR 19-213-395A
214	24,99	3,53	1,5	6,2	7,6	STR 19-214-395A
215	26,57	3,53	1,5	6,2	7,6	STR 19-215-395A
216	28,17	3,53	1,5	6,2	7,6	STR 19-216-395A
217	29,74	3,53	1,5	6,2	7,6	STR 19-217-395A
218	31,34	3,53	1,5	6,2	7,6	STR 19-218-395A
219	32,92	3,53	1,5	6,2	7,6	STR 19-219-395A
220	34,52	3,53	1,5	6,2	7,6	STR 19-220-395A
221	36,09	3,53	1,5	6,2	7,6	STR 19-221-395A
222	37,69	3,53	1,5	6,2	7,6	STR 19-222-395A
223	40,87	3,53	1,5	6,2	7,6	STR 19-223-395A
224	44,04	3,53	1,5	6,2	7,6	STR 19-224-395A
225	47,22	3,53	1,5	6,2	7,6	STR 19-225-395A

6.4

6.4 STR Back-up rings in static radial sealing, inch sizes by dash-number, metric dimensions

Dash-number 226 – 324

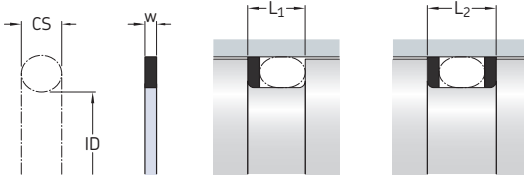

Back-up rings are selected by the corresponding O-ring dimensions.

Dash-number	Dimensions					Designation
	ID	CS	w	L ₁ +0,2	L ₂ +0,2	
–	mm					–
226	50,39	3,53	1,5	6,2	7,6	STR 19-226-395A
227	53,57	3,53	1,5	6,2	7,6	STR 19-227-395A
228	56,74	3,53	1,5	6,2	7,6	STR 19-228-395A
229	59,92	3,53	1,5	6,2	7,6	STR 19-229-395A
230	63,09	3,53	1,5	6,2	7,6	STR 19-230-395A
231	66,27	3,53	1,5	6,2	7,6	STR 19-231-395A
232	69,44	3,53	1,5	6,2	7,6	STR 19-232-395A
233	72,62	3,53	1,5	6,2	7,6	STR 19-233-395A
234	75,79	3,53	1,5	6,2	7,6	STR 19-234-395A
235	78,97	3,53	1,5	6,2	7,6	STR 19-235-395A
236	82,14	3,53	1,5	6,2	7,6	STR 19-236-395A
237	85,32	3,53	1,5	6,2	7,6	STR 19-237-395A
238	88,49	3,53	1,5	6,2	7,6	STR 19-238-395A
239	91,67	3,53	1,5	6,2	7,6	STR 19-239-395A
240	94,84	3,53	1,5	6,2	7,6	STR 19-240-395A
242	101,19	3,53	1,5	6,2	7,6	STR 19-242-395A
243	104,37	3,53	1,5	6,2	7,6	STR 19-243-395A
244	107,54	3,53	1,5	6,2	7,6	STR 19-244-395A
245	110,72	3,53	1,5	6,2	7,6	STR 19-245-395A
246	113,89	3,53	1,5	6,2	7,6	STR 19-246-395A
247	117,07	3,53	1,5	6,2	7,6	STR 19-247-395A

Dash-number	Dimensions					Designation
	ID	CS	w	L ₁ +0,2	L ₂ +0,2	
-	mm					-
248	120,24	3,53	1,5	6,2	7,6	STR 19-248-395A
249	123,42	3,53	1,5	6,2	7,6	STR 19-249-395A
250	126,59	3,53	1,5	6,2	7,6	STR 19-250-395A
251	129,77	3,53	1,5	6,2	7,6	STR 19-251-395A
252	132,94	3,53	1,5	6,2	7,6	STR 19-252-395A
253	136,12	3,53	1,5	6,2	7,6	STR 19-253-395A
254	139,29	3,53	1,5	6,2	7,6	STR 19-254-395A
255	142,47	3,53	1,5	6,2	7,6	STR 19-255-395A
256	145,64	3,53	1,5	6,2	7,6	STR 19-256-395A
257	148,82	3,53	1,5	6,2	7,6	STR 19-257-395A
258	151,99	3,53	1,5	6,2	7,6	STR 19-258-395A
259	158,34	3,53	1,5	6,2	7,6	STR 19-259-395A
260	164,69	3,53	1,5	6,2	7,6	STR 19-260-395A
261	171,04	3,53	1,5	6,2	7,6	STR 19-261-395A
262	177,39	3,53	1,5	6,2	7,6	STR 19-262-395A
265	196,44	3,53	1,5	6,2	7,6	STR 19-265-395A
266	202,79	3,53	1,5	6,2	7,6	STR 19-266-395A
267	209,14	3,53	1,5	6,2	7,6	STR 19-267-395A
268	215,49	3,53	1,5	6,2	7,6	STR 19-268-395A
269	221,84	3,53	1,5	6,2	7,6	STR 19-269-395A
270	228,19	3,53	1,5	6,2	7,6	STR 19-270-395A
271	234,54	3,53	1,5	6,2	7,6	STR 19-271-395A
272	240,89	3,53	1,5	6,2	7,6	STR 19-272-395A
273	247,24	3,53	1,5	6,2	7,6	STR 19-273-395A
314	18,42	5,33	1,7	8,8	10,5	STR 19-314-395A
316	21,59	5,33	1,7	8,8	10,5	STR 19-316-395A
317	23,16	5,33	1,7	8,8	10,5	STR 19-317-395A
318	24,77	5,33	1,7	8,8	10,5	STR 19-318-395A
319	26,34	5,33	1,7	8,8	10,5	STR 19-319-395A
320	27,94	5,33	1,7	8,8	10,5	STR 19-320-395A
321	29,51	5,33	1,7	8,8	10,5	STR 19-321-395A
322	31,12	5,33	1,7	8,8	10,5	STR 19-322-395A
323	32,69	5,33	1,7	8,8	10,5	STR 19-323-395A
324	34,29	5,33	1,7	8,8	10,5	STR 19-324-395A

6.4

6.4 STR Back-up rings in static radial sealing, inch sizes by dash-number, metric dimensions

Dash-number 325 – 429

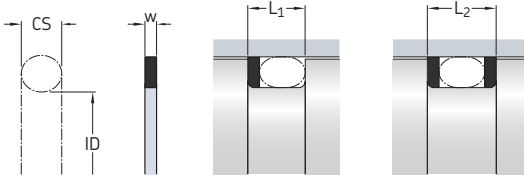

Back-up rings are selected by the corresponding O-ring dimensions.

Dash-number	Dimensions					Designation
	ID	CS	w	L ₁ +0,2	L ₂ +0,2	
–	mm					–
325	37,47	5,33	1,7	8,8	10,5	STR 19-325-395A
326	40,64	5,33	1,7	8,8	10,5	STR 19-326-395A
327	43,82	5,33	1,7	8,8	10,5	STR 19-327-395A
328	46,99	5,33	1,7	8,8	10,5	STR 19-328-395A
329	50,17	5,33	1,7	8,8	10,5	STR 19-329-395A
330	53,34	5,33	1,7	8,8	10,5	STR 19-330-395A
331	56,52	5,33	1,7	8,8	10,5	STR 19-331-395A
332	59,69	5,33	1,7	8,8	10,5	STR 19-332-395A
333	62,87	5,33	1,7	8,8	10,5	STR 19-333-395A
334	66,04	5,33	1,7	8,8	10,5	STR 19-334-395A
335	69,22	5,33	1,7	8,8	10,5	STR 19-335-395A
336	72,39	5,33	1,7	8,8	10,5	STR 19-336-395A
337	75,57	5,33	1,7	8,8	10,5	STR 19-337-395A
338	78,74	5,33	1,7	8,8	10,5	STR 19-338-395A
339	81,92	5,33	1,7	8,8	10,5	STR 19-339-395A
340	85,09	5,33	1,7	8,8	10,5	STR 19-340-395A
341	88,27	5,33	1,7	8,8	10,5	STR 19-341-395A
342	91,44	5,33	1,7	8,8	10,5	STR 19-342-395A
343	94,62	5,33	1,7	8,8	10,5	STR 19-343-395A
344	97,79	5,33	1,7	8,8	10,5	STR 19-344-395A
345	100,97	5,33	1,7	8,8	10,5	STR 19-345-395A

Dash-number	Dimensions					Designation
	ID	CS	w	L ₁ +0,2	L ₂ +0,2	
-	mm					-
346	104,14	5,33	1,7	8,8	10,5	STR 19-346-395A
347	107,32	5,33	1,7	8,8	10,5	STR 19-347-395A
348	110,49	5,33	1,7	8,8	10,5	STR 19-348-395A
349	113,67	5,33	1,7	8,8	10,5	STR 19-349-395A
350	116,84	5,33	1,7	8,8	10,5	STR 19-350-395A
351	120,02	5,33	1,7	8,8	10,5	STR 19-351-395A
352	123,19	5,33	1,7	8,8	10,5	STR 19-352-395A
353	126,37	5,33	1,7	8,8	10,5	STR 19-353-395A
354	129,54	5,33	1,7	8,8	10,5	STR 19-354-395A
355	132,72	5,33	1,7	8,8	10,5	STR 19-355-395A
356	135,89	5,33	1,7	8,8	10,5	STR 19-356-395A
357	139,07	5,33	1,7	8,8	10,5	STR 19-357-395A
358	142,24	5,33	1,7	8,8	10,5	STR 19-358-395A
359	145,42	5,33	1,7	8,8	10,5	STR 19-359-395A
360	148,59	5,33	1,7	8,8	10,5	STR 19-360-395A
361	151,77	5,33	1,7	8,8	10,5	STR 19-361-395A
362	158,12	5,33	1,7	8,8	10,5	STR 19-362-395A
363	164,47	5,33	1,7	8,8	10,5	STR 19-363-395A
364	170,82	5,33	1,7	8,8	10,5	STR 19-364-395A
365	177,17	5,33	1,7	8,8	10,5	STR 19-365-395A
366	183,52	5,33	1,7	8,8	10,5	STR 19-366-395A
367	189,87	5,33	1,7	8,8	10,5	STR 19-367-395A
368	196,22	5,33	1,7	8,8	10,5	STR 19-368-395A
369	202,57	5,33	1,7	8,8	10,5	STR 19-369-395A
370	208,92	5,33	1,7	8,8	10,5	STR 19-370-395A
371	215,27	5,33	1,7	8,8	10,5	STR 19-371-395A
372	221,62	5,33	1,7	8,8	10,5	STR 19-372-395A
373	227,97	5,33	1,7	8,8	10,5	STR 19-373-395A
374	234,32	5,33	1,7	8,8	10,5	STR 19-374-395A
375	240,67	5,33	1,7	8,8	10,5	STR 19-375-395A
425	113,67	6,99	2	12	14,5	STR 19-425-395A
426	116,84	6,99	2	12	14,5	STR 19-426-395A
427	120,02	6,99	2	12	14,5	STR 19-427-395A
428	123,19	6,99	2	12	14,5	STR 19-428-395A
429	126,37	6,99	2	12	14,5	STR 19-429-395A

6.4 STR Back-up rings in static radial sealing, inch sizes by dash-number, metric dimensions

Dash-number 430 – 449

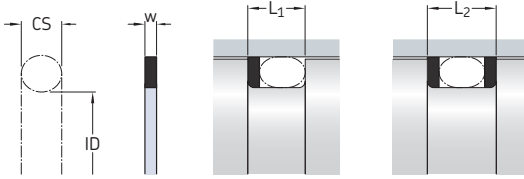

Back-up rings are selected by the corresponding O-ring dimensions.

Dash-number	Dimensions					Designation
	ID	CS	w	L ₁ +0,2	L ₂ +0,2	
–	mm					–
430	129,54	6,99	2	12	14,5	STR 19-430-395A
431	132,72	6,99	2	12	14,5	STR 19-431-395A
432	135,89	6,99	2	12	14,5	STR 19-432-395A
433	139,07	6,99	2	12	14,5	STR 19-433-395A
434	142,24	6,99	2	12	14,5	STR 19-434-395A
435	145,42	6,99	2	12	14,5	STR 19-435-395A
436	148,59	6,99	2	12	14,5	STR 19-436-395A
437	151,77	6,99	2	12	14,5	STR 19-437-395A
438	158,12	6,99	2	12	14,5	STR 19-438-395A
439	164,47	6,99	2	12	14,5	STR 19-439-395A
440	170,82	6,99	2	12	14,5	STR 19-440-395A
441	177,17	6,99	2	12	14,5	STR 19-441-395A
442	183,52	6,99	2	12	14,5	STR 19-442-395A
443	189,87	6,99	2	12	14,5	STR 19-443-395A
444	196,22	6,99	2	12	14,5	STR 19-444-395A
445	202,57	6,99	2	12	14,5	STR 19-445-395A
446	215,27	6,99	2	12	14,5	STR 19-446-395A
447	227,97	6,99	2	12	14,5	STR 19-447-395A
448	240,67	6,99	2	12	14,5	STR 19-448-395A
449	253,37	6,99	2	12	14,5	STR 19-449-395A

Other sizes are available on request

6.5 STR Back-up rings in static radial sealing, inch sizes by dash-number

Dash-number **013 – 167**

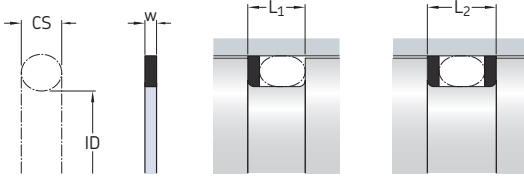

Back-up rings are selected by the corresponding O-ring dimensions.

Dash-number	Dimensions					Designation
	CS	ID	w	L ₁ +0.008	L ₂ +0.008	
-	in.					-
013	0,07	0,426	0,043	0,15	0,205	STR 19-013-395A
014	0,07	0,489	0,043	0,15	0,205	STR 19-014-395A
015	0,07	0,551	0,043	0,15	0,205	STR 19-015-395A
016	0,07	0,614	0,043	0,15	0,205	STR 19-016-395A
017	0,07	0,676	0,043	0,15	0,205	STR 19-017-395A
018	0,07	0,739	0,043	0,15	0,205	STR 19-018-395A
019	0,07	0,801	0,043	0,15	0,205	STR 19-019-395A
020	0,07	0,864	0,043	0,15	0,205	STR 19-020-395A
021	0,07	0,926	0,043	0,15	0,205	STR 19-021-395A
022	0,07	0,989	0,043	0,15	0,205	STR 19-022-395A
023	0,07	1,051	0,043	0,15	0,205	STR 19-023-395A
024	0,07	1,114	0,043	0,15	0,205	STR 19-024-395A
025	0,07	1,176	0,043	0,15	0,205	STR 19-025-395A
026	0,07	1,239	0,043	0,15	0,205	STR 19-026-395A
027	0,07	1,301	0,043	0,15	0,205	STR 19-027-395A
028	0,07	1,364	0,043	0,15	0,205	STR 19-028-395A
029	0,07	1,489	0,043	0,15	0,205	STR 19-029-395A
030	0,07	1,614	0,043	0,15	0,205	STR 19-030-395A
031	0,07	1,739	0,043	0,15	0,205	STR 19-031-395A
032	0,07	1,864	0,043	0,15	0,205	STR 19-032-395A
033	0,07	1,989	0,043	0,15	0,205	STR 19-033-395A
034	0,07	2,114	0,043	0,15	0,205	STR 19-034-395A
035	0,07	2,239	0,043	0,15	0,205	STR 19-035-395A
036	0,07	2,364	0,043	0,15	0,205	STR 19-036-395A
037	0,07	2,489	0,043	0,15	0,205	STR 19-037-395A
038	0,07	2,614	0,043	0,15	0,205	STR 19-038-395A
039	0,07	2,739	0,043	0,15	0,205	STR 19-039-395A
040	0,07	2,864	0,043	0,15	0,205	STR 19-040-395A
041	0,07	2,989	0,043	0,15	0,205	STR 19-041-395A
042	0,07	3,239	0,043	0,15	0,205	STR 19-042-395A
043	0,07	3,489	0,043	0,15	0,205	STR 19-043-395A
044	0,07	3,739	0,043	0,15	0,205	STR 19-044-395A
045	0,07	3,989	0,043	0,15	0,205	STR 19-045-395A
046	0,07	4,239	0,043	0,15	0,205	STR 19-046-395A

Dash-number	Dimensions					Designation
	CS	ID	w	L ₁ +0,008	L ₂ +0,008	
-	in.					-
047	0,07	4,489	0,043	0,15	0,205	STR 19-047-395A
048	0,07	4,739	0,043	0,15	0,205	STR 19-048-395A
049	0,07	4,989	0,043	0,15	0,205	STR 19-049-395A
050	0,07	5,239	0,043	0,15	0,205	STR 19-050-395A
111	0,103	0,424	0,051	0,197	0,252	STR 19-111-395A
112	0,103	0,487	0,051	0,197	0,252	STR 19-112-395A
113	0,103	0,549	0,051	0,197	0,252	STR 19-113-395A
114	0,103	0,612	0,051	0,197	0,252	STR 19-114-395A
115	0,103	0,674	0,051	0,197	0,252	STR 19-115-395A
116	0,103	0,737	0,051	0,197	0,252	STR 19-116-395A
117	0,103	0,799	0,051	0,197	0,252	STR 19-117-395A
118	0,103	0,862	0,051	0,197	0,252	STR 19-118-395A
119	0,103	0,924	0,051	0,197	0,252	STR 19-119-395A
120	0,103	0,987	0,051	0,197	0,252	STR 19-120-395A
121	0,103	1,049	0,051	0,197	0,252	STR 19-121-395A
122	0,103	1,112	0,051	0,197	0,252	STR 19-122-395A
123	0,103	1,174	0,051	0,197	0,252	STR 19-123-395A
124	0,103	1,237	0,051	0,197	0,252	STR 19-124-395A
125	0,103	1,299	0,051	0,197	0,252	STR 19-125-395A
126	0,103	1,362	0,051	0,197	0,252	STR 19-126-395A
127	0,103	1,424	0,051	0,197	0,252	STR 19-127-395A
128	0,103	1,487	0,051	0,197	0,252	STR 19-128-395A
129	0,103	1,549	0,051	0,197	0,252	STR 19-129-395A
130	0,103	1,612	0,051	0,197	0,252	STR 19-130-395A
131	0,103	1,674	0,051	0,197	0,252	STR 19-131-395A
132	0,103	1,737	0,051	0,197	0,252	STR 19-132-395A
133	0,103	1,799	0,051	0,197	0,252	STR 19-133-395A
134	0,103	1,862	0,051	0,197	0,252	STR 19-134-395A
135	0,103	1,925	0,051	0,197	0,252	STR 19-135-395A
136	0,103	1,987	0,051	0,197	0,252	STR 19-136-395A
137	0,103	2,05	0,051	0,197	0,252	STR 19-137-395A
138	0,103	2,112	0,051	0,197	0,252	STR 19-138-395A
139	0,103	2,175	0,051	0,197	0,252	STR 19-139-395A
140	0,103	2,237	0,051	0,197	0,252	STR 19-140-395A
141	0,103	2,3	0,051	0,197	0,252	STR 19-141-395A
142	0,103	2,362	0,051	0,197	0,252	STR 19-142-395A
143	0,103	2,425	0,051	0,197	0,252	STR 19-143-395A
144	0,103	2,487	0,051	0,197	0,252	STR 19-144-395A
145	0,103	2,55	0,051	0,197	0,252	STR 19-145-395A
146	0,103	2,612	0,051	0,197	0,252	STR 19-146-395A
147	0,103	2,675	0,051	0,197	0,252	STR 19-147-395A
148	0,103	2,737	0,051	0,197	0,252	STR 19-148-395A
149	0,103	2,8	0,051	0,197	0,252	STR 19-149-395A
150	0,103	2,862	0,051	0,197	0,252	STR 19-150-395A
151	0,103	2,987	0,051	0,197	0,252	STR 19-151-395A
152	0,103	3,237	0,051	0,197	0,252	STR 19-152-395A
153	0,103	3,487	0,051	0,197	0,252	STR 19-153-395A
154	0,103	3,737	0,051	0,197	0,252	STR 19-154-395A
155	0,103	3,987	0,051	0,197	0,252	STR 19-155-395A
158	0,103	4,737	0,051	0,197	0,252	STR 19-158-395A
159	0,103	4,987	0,051	0,197	0,252	STR 19-159-395A
160	0,103	5,237	0,051	0,197	0,252	STR 19-160-395A
161	0,103	5,487	0,051	0,197	0,252	STR 19-161-395A
162	0,103	5,737	0,051	0,197	0,252	STR 19-162-395A
163	0,103	5,987	0,051	0,197	0,252	STR 19-163-395A
167	0,103	6,987	0,051	0,197	0,252	STR 19-167-395A

6.5 STR Back-up rings in static radial sealing, inch sizes by dash-number

Dash-number 205 – 339

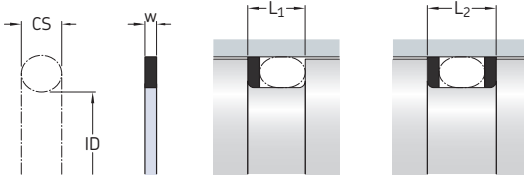

Back-up rings are selected by the corresponding O-ring dimensions.

Dash-number	Dimensions					Designation
	CS	ID	w	L ₁ +0,008	L ₂ +0,008	
–	in.					–
205	0,139	0,421	0,051	0,244	0,299	STR 19-205-395A
206	0,139	0,484	0,051	0,244	0,299	STR 19-206-395A
207	0,139	0,546	0,051	0,244	0,299	STR 19-207-395A
208	0,139	0,609	0,051	0,244	0,299	STR 19-208-395A
209	0,139	0,671	0,051	0,244	0,299	STR 19-209-395A
210	0,139	0,734	0,051	0,244	0,299	STR 19-210-395A
211	0,139	0,796	0,051	0,244	0,299	STR 19-211-395A
212	0,139	0,859	0,051	0,244	0,299	STR 19-212-395A
213	0,139	0,921	0,051	0,244	0,299	STR 19-213-395A
214	0,139	0,984	0,051	0,244	0,299	STR 19-214-395A
215	0,139	1,046	0,051	0,244	0,299	STR 19-215-395A
216	0,139	1,109	0,051	0,244	0,299	STR 19-216-395A
217	0,139	1,171	0,051	0,244	0,299	STR 19-217-395A
218	0,139	1,234	0,051	0,244	0,299	STR 19-218-395A
219	0,139	1,296	0,051	0,244	0,299	STR 19-219-395A
220	0,139	1,359	0,051	0,244	0,299	STR 19-220-395A
221	0,139	1,421	0,051	0,244	0,299	STR 19-221-395A
222	0,139	1,484	0,051	0,244	0,299	STR 19-222-395A
223	0,139	1,609	0,051	0,244	0,299	STR 19-223-395A
224	0,139	1,734	0,051	0,244	0,299	STR 19-224-395A
225	0,139	1,859	0,051	0,244	0,299	STR 19-225-395A
226	0,139	1,984	0,051	0,244	0,299	STR 19-226-395A
227	0,139	2,109	0,051	0,244	0,299	STR 19-227-395A
228	0,139	2,234	0,051	0,244	0,299	STR 19-228-395A
229	0,139	2,359	0,051	0,244	0,299	STR 19-229-395A
230	0,139	2,484	0,051	0,244	0,299	STR 19-230-395A
231	0,139	2,609	0,051	0,244	0,299	STR 19-231-395A
232	0,139	2,734	0,051	0,244	0,299	STR 19-232-395A
233	0,139	2,859	0,051	0,244	0,299	STR 19-233-395A
234	0,139	2,984	0,051	0,244	0,299	STR 19-234-395A
235	0,139	3,109	0,051	0,244	0,299	STR 19-235-395A
236	0,139	3,234	0,051	0,244	0,299	STR 19-236-395A
237	0,139	3,359	0,051	0,244	0,299	STR 19-237-395A
238	0,139	3,484	0,051	0,244	0,299	STR 19-238-395A
239	0,139	3,609	0,051	0,244	0,299	STR 19-239-395A
240	0,139	3,734	0,051	0,244	0,299	STR 19-240-395A

Dash-number	Dimensions			Designation		
	CS	ID	w	L ₁ +0,008	L ₂ +0,008	
-	in.			-		
242	0,139	3,984	0,051	0,244	0,299	STR 19-242-395A
243	0,139	4,109	0,051	0,244	0,299	STR 19-243-395A
244	0,139	4,234	0,051	0,244	0,299	STR 19-244-395A
245	0,139	4,359	0,051	0,244	0,299	STR 19-245-395A
246	0,139	4,484	0,051	0,244	0,299	STR 19-246-395A
247	0,139	4,609	0,051	0,244	0,299	STR 19-247-395A
248	0,139	4,734	0,051	0,244	0,299	STR 19-248-395A
249	0,139	4,859	0,051	0,244	0,299	STR 19-249-395A
250	0,139	4,984	0,051	0,244	0,299	STR 19-250-395A
251	0,139	5,109	0,051	0,244	0,299	STR 19-251-395A
252	0,139	5,234	0,051	0,244	0,299	STR 19-252-395A
253	0,139	5,359	0,051	0,244	0,299	STR 19-253-395A
254	0,139	5,484	0,051	0,244	0,299	STR 19-254-395A
255	0,139	5,609	0,051	0,244	0,299	STR 19-255-395A
256	0,139	5,734	0,051	0,244	0,299	STR 19-256-395A
257	0,139	5,859	0,051	0,244	0,299	STR 19-257-395A
258	0,139	5,984	0,051	0,244	0,299	STR 19-258-395A
259	0,139	6,234	0,051	0,244	0,299	STR 19-259-395A
260	0,139	6,484	0,051	0,244	0,299	STR 19-260-395A
261	0,139	6,734	0,051	0,244	0,299	STR 19-261-395A
262	0,139	6,984	0,051	0,244	0,299	STR 19-262-395A
265	0,139	7,734	0,051	0,244	0,299	STR 19-265-395A
266	0,139	7,984	0,051	0,244	0,299	STR 19-266-395A
267	0,139	8,234	0,051	0,244	0,299	STR 19-267-395A
268	0,139	8,484	0,051	0,244	0,299	STR 19-268-395A
269	0,139	8,734	0,051	0,244	0,299	STR 19-269-395A
270	0,139	8,984	0,051	0,244	0,299	STR 19-270-395A
271	0,139	9,234	0,051	0,244	0,299	STR 19-271-395A
272	0,139	9,484	0,051	0,244	0,299	STR 19-272-395A
273	0,139	9,734	0,051	0,244	0,299	STR 19-273-395A
310	0,21	0,475	0,067	0,346	0,413	STR 19-310-395A
311	0,21	0,537	0,067	0,346	0,413	STR 19-311-395A
312	0,21	0,6	0,067	0,346	0,413	STR 19-312-395A
313	0,21	0,662	0,067	0,346	0,413	STR 19-313-395A
314	0,21	0,725	0,067	0,346	0,413	STR 19-314-395A
315	0,21	0,787	0,067	0,346	0,413	STR 19-315-395A
316	0,21	0,85	0,067	0,346	0,413	STR 19-316-395A
317	0,21	0,912	0,067	0,346	0,413	STR 19-317-395A
318	0,21	0,975	0,067	0,346	0,413	STR 19-318-395A
319	0,21	1,037	0,067	0,346	0,413	STR 19-319-395A
320	0,21	1,1	0,067	0,346	0,413	STR 19-320-395A
321	0,21	1,162	0,067	0,346	0,413	STR 19-321-395A
322	0,21	1,225	0,067	0,346	0,413	STR 19-322-395A
323	0,21	1,287	0,067	0,346	0,413	STR 19-323-395A
324	0,21	1,35	0,067	0,346	0,413	STR 19-324-395A
325	0,21	1,475	0,067	0,346	0,413	STR 19-325-395A
326	0,21	1,6	0,067	0,346	0,413	STR 19-326-395A
327	0,21	1,725	0,067	0,346	0,413	STR 19-327-395A
328	0,21	1,85	0,067	0,346	0,413	STR 19-328-395A
329	0,21	1,975	0,067	0,346	0,413	STR 19-329-395A
330	0,21	2,1	0,067	0,346	0,413	STR 19-330-395A
331	0,21	2,225	0,067	0,346	0,413	STR 19-331-395A
332	0,21	2,35	0,067	0,346	0,413	STR 19-332-395A
333	0,21	2,475	0,067	0,346	0,413	STR 19-333-395A
334	0,21	2,6	0,067	0,346	0,413	STR 19-334-395A
335	0,21	2,725	0,067	0,346	0,413	STR 19-335-395A
336	0,21	2,85	0,067	0,346	0,413	STR 19-336-395A
337	0,21	2,975	0,067	0,346	0,413	STR 19-337-395A
338	0,21	3,1	0,067	0,346	0,413	STR 19-338-395A
339	0,21	3,225	0,067	0,346	0,413	STR 19-339-395A

6.5 STR Back-up rings in static radial sealing, inch sizes by dash-number

Dash-number 340 – 449

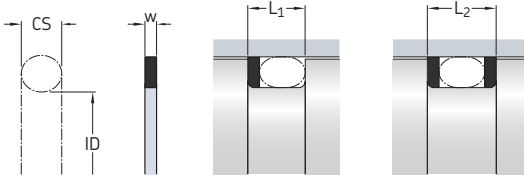

Back-up rings are selected by the corresponding O-ring dimensions.

Dash-number	Dimensions					Designation
	CS	ID	w	L ₁ +0.008	L ₂ +0.008	
-	in.					-
340	0,21	3,35	0,067	0,346	0,413	STR 19-340-395A
341	0,21	3,475	0,067	0,346	0,413	STR 19-341-395A
342	0,21	3,6	0,067	0,346	0,413	STR 19-342-395A
343	0,21	3,725	0,067	0,346	0,413	STR 19-343-395A
344	0,21	3,85	0,067	0,346	0,413	STR 19-344-395A
345	0,21	3,975	0,067	0,346	0,413	STR 19-345-395A
346	0,21	4,1	0,067	0,346	0,413	STR 19-346-395A
347	0,21	4,225	0,067	0,346	0,413	STR 19-347-395A
348	0,21	4,35	0,067	0,346	0,413	STR 19-348-395A
349	0,21	4,475	0,067	0,346	0,413	STR 19-349-395A
350	0,21	4,6	0,067	0,346	0,413	STR 19-350-395A
351	0,21	4,725	0,067	0,346	0,413	STR 19-351-395A
352	0,21	4,85	0,067	0,346	0,413	STR 19-352-395A
353	0,21	4,975	0,067	0,346	0,413	STR 19-353-395A
354	0,21	5,1	0,067	0,346	0,413	STR 19-354-395A
355	0,21	5,225	0,067	0,346	0,413	STR 19-355-395A
356	0,21	5,35	0,067	0,346	0,413	STR 19-356-395A
357	0,21	5,475	0,067	0,346	0,413	STR 19-357-395A
358	0,21	5,6	0,067	0,346	0,413	STR 19-358-395A
359	0,21	5,725	0,067	0,346	0,413	STR 19-359-395A
360	0,21	5,85	0,067	0,346	0,413	STR 19-360-395A
361	0,21	5,975	0,067	0,346	0,413	STR 19-361-395A
362	0,21	6,225	0,067	0,346	0,413	STR 19-362-395A
363	0,21	6,475	0,067	0,346	0,413	STR 19-363-395A
364	0,21	6,725	0,067	0,346	0,413	STR 19-364-395A
365	0,21	6,975	0,067	0,346	0,413	STR 19-365-395A
366	0,21	7,225	0,067	0,346	0,413	STR 19-366-395A
367	0,21	7,475	0,067	0,346	0,413	STR 19-367-395A
368	0,21	7,725	0,067	0,346	0,413	STR 19-368-395A
369	0,21	7,975	0,067	0,346	0,413	STR 19-369-395A
370	0,21	8,225	0,067	0,346	0,413	STR 19-370-395A
371	0,21	8,475	0,067	0,346	0,413	STR 19-371-395A
372	0,21	8,725	0,067	0,346	0,413	STR 19-372-395A
373	0,21	8,975	0,067	0,346	0,413	STR 19-373-395A
374	0,21	9,225	0,067	0,346	0,413	STR 19-374-395A
375	0,21	9,475	0,067	0,346	0,413	STR 19-375-395A

Dash-number	Dimensions					Designation
	CS	ID	w	L ₁ +0,008	L ₂ +0,008	
-	in.					-
425	0,275	4,475	0,079	0,472	0,571	STR 19-425-395A
426	0,275	4,6	0,079	0,472	0,571	STR 19-426-395A
427	0,275	4,725	0,079	0,472	0,571	STR 19-427-395A
428	0,275	4,85	0,079	0,472	0,571	STR 19-428-395A
429	0,275	4,975	0,079	0,472	0,571	STR 19-429-395A
430	0,275	5,1	0,079	0,472	0,571	STR 19-430-395A
431	0,275	5,225	0,079	0,472	0,571	STR 19-431-395A
432	0,275	5,35	0,079	0,472	0,571	STR 19-432-395A
433	0,275	5,475	0,079	0,472	0,571	STR 19-433-395A
434	0,275	5,6	0,079	0,472	0,571	STR 19-434-395A
435	0,275	5,725	0,079	0,472	0,571	STR 19-435-395A
436	0,275	5,85	0,079	0,472	0,571	STR 19-436-395A
437	0,275	5,975	0,079	0,472	0,571	STR 19-437-395A
438	0,275	6,225	0,079	0,472	0,571	STR 19-438-395A
439	0,275	6,475	0,079	0,472	0,571	STR 19-439-395A
440	0,275	6,725	0,079	0,472	0,571	STR 19-440-395A
441	0,275	6,975	0,079	0,472	0,571	STR 19-441-395A
442	0,275	7,225	0,079	0,472	0,571	STR 19-442-395A
443	0,275	7,475	0,079	0,472	0,571	STR 19-443-395A
444	0,275	7,725	0,079	0,472	0,571	STR 19-444-395A
445	0,275	7,975	0,079	0,472	0,571	STR 19-445-395A
446	0,275	8,475	0,079	0,472	0,571	STR 19-446-395A
447	0,275	8,975	0,079	0,472	0,571	STR 19-447-395A
448	0,275	9,475	0,079	0,472	0,571	STR 19-448-395A
449	0,275	9,975	0,079	0,472	0,571	STR 19-449-395A

Other sizes are available on request

Other O-ring sealing and ring materials

Dynamic radial sealing

Under certain conditions, O-rings can be used for dynamic sealing with relative motion between the coaxial parts. These sealing arrangements are limited to slow reciprocating or oscillating motions. The radial depth S should be increased to S_1 using

$$S_1 = \frac{CS + S}{2}$$

where

S_1 = increased radial depth [mm]
 CS = cross section [mm] (→ **product tables**)
 S = radial depth [mm]
 = $(D - d_1) / 2$ for outside grooves
 = $(D_1 - d) / 2$ for inside grooves

For additional dimensions, refer to the relevant standards (→ **table 3, page 294**).

For additional information, contact SKF.

Static axial sealing

O-rings can also be used for static axial sealing between two opposing parts. Although, static axial sealing arrangements are not common in hydraulic cylinder applications, some examples are shown in **figure 3**.

For additional information, contact SKF.

Fig. 3

Static axial sealing examples

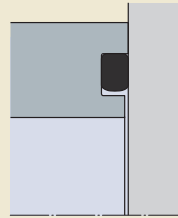

Rectangular groove, inside pressure

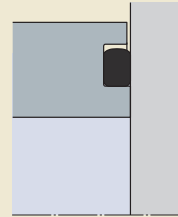

Rectangular groove, outside pressure

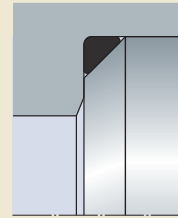

Triangular groove

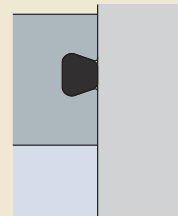

Trapezoidal groove

PTFE encapsulated O-rings

SKF also supplies O-rings type ECOR that are encapsulated with PTFE materials (FEP or PFA). These O-rings have a core made of silicone or fluorocarbon rubber. The seamless and uniform PTFE encapsulation protects the core material against fluids and air.

ECOR O-rings are preferred for static sealing and not appropriate for continuously dynamic applications due to its thin and soft encapsulation. They are characterized by the following properties:

- chemical resistant
- wide temperature range
- anti-adhesive, low breakaway friction
- good resistance to wear
- good resistance to UV light
- can be sterilized in accordance with FDA (Food and Drug Administration) requirements
- low steam permeability
- low water absorption

For available sizes and additional information, contact SKF.

Back-up rings made of thermoplastic polyester elastomer

SKF also supplies back-up rings made of thermoplastic polyester elastomer (TPC).

For additional information, contact SKF.

Back-up rings made of PTFE

SKF back-up rings made of PTFE are suitable in applications with high temperatures or aggressive fluids. PTFE back-up rings are available unfilled or with an appropriate filler. Back-up rings made of unfilled PTFE can be machined from tube blanks with outside diameters ranging from 1 to 1 500 mm (0.039 to 59 in.). Therefore, they can easily be adapted to customer specific installations and delivered on short notice.

For additional information, contact SKF.



Other fluid power applications

Hydraulic rock breaker hammers	348
Hydraulic presses	349
Hinge pin joints	349
Rotary unions	350
Hydraulic motors	350
Pneumatic fluid power applications . .	351

Other fluid power applications

This catalogue contains the standard assortment of SKF hydraulic seals and guides typically used in hydraulic cylinders. Furthermore, SKF provides a wide range of standard and customized sealing solutions for a variety of other fluid power applications. In this chapter, you find some examples of these capabilities. For a solution that best meets the demands of your application, contact SKF.

Hydraulic rock breaker hammers

Hydraulic rock breaker hammers are a demanding application requiring hydraulic reciprocating seals working in short strokes and extreme high velocity.

SKF has many special solutions for rock hammers, including TEFLATHANE seals with a special high-temperature polyurethane U-cup seal that is bonded to a low-friction PTFE anti-extrusion ring to extend service life for significant maintenance savings.

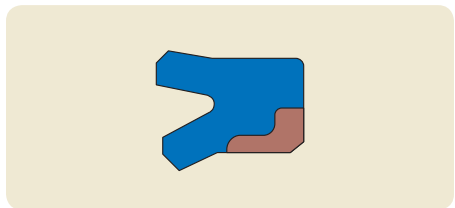

Hydraulic presses

Each hydraulic press application is unique and should work reliably for many years without costly downtime or expensive repairs. SKF has decades of experience developing and manufacturing customized press sealing solutions for original equipment manufacturers, as well as retrofit assemblies for existing equipment.

With moulding and machining capabilities and virtually unlimited diameter range, SKF can customize and manufacture sealing solutions to optimize system performance and decrease operating costs.



Hinge pin joints

Hinge pin seals retain pin joint bearing lubricants and exclude contaminants on off highway equipment that operates in harsh outdoor environments across all climates and weather conditions.

PAK-L press-in seals are optimized for demanding pin joint applications. The wear resistant polyurethane seal materials reduce relubrication intervals and extend both seal and hinge joint bearing life. In addition, SKF has experience developing customized pin joint seal solutions.



Other fluid power applications

Rotary unions

Rotary unions (also known as rotary manifolds or swivel joints) accommodate the flow of fluids between machine components with relative rotating or oscillating motion. They convey gases, lubricants, coolants and working fluids for fluid power.

SKF has sealing solutions and capabilities to accommodate virtually any rotary union application. The IM profile seal for hydraulic rotary manifolds is optimized for low friction and is available with a bonded energizer to improve energy efficiency and extend service life.



Hydraulic motors

Hydraulic motors rotate with high torque from high-pressure hydraulic fluid flow. Certain motor designs and applications require the shaft seal to handle high pressure. The demands for higher power, efficient operation and long life require other solutions than typical rubber shaft seals.

SKF designs and develops customized high-pressure PTFE shaft seals for hydraulic motors for reduced friction and wear to support energy saving and extend service life.

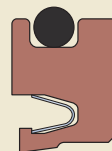

Pneumatic fluid power applications

Special gas-sealing applications with high pressure, high speed, extreme high temperatures, cryogenic low temperatures or special gases place high demands on pneumatic seals.

SKF can provide customized solutions that meets your most demanding pneumatic sealing needs, designed specifically to enhance reliability and performance in your application.

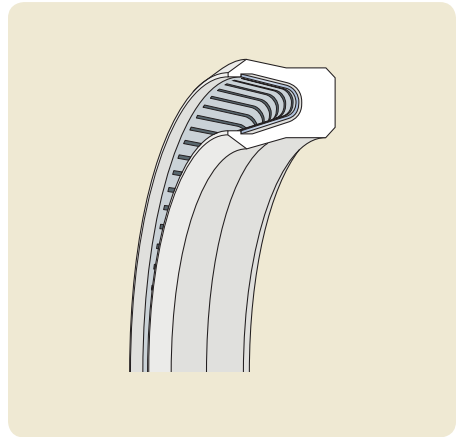

Product index

Profile/ designation	Product	Section No.	Profile data Page	Product tables	
				Page ¹⁾ Metric	Inch
APR	Piston seals	2.6	76	77	79
CPV	Piston seals	2.4	64	–	65
CUT	Piston seals	2.9	90	91	–
DPV	Piston seals	2.2	60	–	61
DTW	Wiper seals	4.4	228	229	232
DX	Wiper seals	4.5	236	–	237
DZ	Rod seals	3.6	178	179	180
DZR	Rod seals	3.7	184	185	186
GH	Piston seals	2.5	66	67	70
HW	Wiper seals	4.6	240	241	243
LCP	Piston seals	2.7	82	83	85
LPV	Piston seals	2.3	62	63	–
LTP	Piston seals	2.8	86	–	87
MCW	Wiper seals	4.2	220	221	223
MD-L	Piston seals	2.11	98	99	–
MPV	Piston seals	2.1	58	59	–
OR	O-rings (metric)	6.1	–	300	–
	O-rings (inch)	6.2	–	–	316
PA	Wiper seals	4.1	216	217	–
PAD	Wiper seals	4.3	226	227	–
PADV	Wiper seals	4.3	226	227	–
PGR	Piston guide rings	5.4	–	280	–
PTB	Rod seals	3.4	138	139	149
RBB	Buffer seals	3.8	188	189	191
RGR	Rod guide rings	5.3	–	276	–
RSB	Buffer seals	3.10	198	–	199
S1S	Rod seals	3.1	122	123	–
S9B	Buffer seals	3.9	192	193	196
SCP	Piston seals	2.10	94	–	95
SIL	Rod seals	3.3	134	135	–
STD	Rod seals	3.5	164	–	165
STR	Back-up rings (metric)	6.3	–	324	–
	Back-up rings (inch sizes by dash-number, metric dimensions)	6.4	–	328	–
	Back-up rings (inch)	6.5	–	–	338
UNP	Piston seals	2.12	102	103	105
WAT	Rod or piston guide rings (metric)	5.1	–	256	–
	Rod or piston guide rings (inch)	5.2	–	–	262
ZBR	Rod seals	3.2	126	127	131

¹⁾ Starting page of the product table

